

■ 概述

L7808 系列为3端负稳压电路,TO-220 封装,能提供多种固定的输出电压,应用范围广。内含过流、过热和过载保护电路。带散热片时,输出电流可达**1.2A**。虽然是固定稳压电路,但使用外接元件,可获得不同的电压和电流。

■ 主要特点

- 输出电流可达 1.2A, 输出电压有: 8V
- 过热保护
- 短路保护
- 输出晶体管SOA保护。

■ 极限值 (T_a=25°C)

V _I	— 输入电压	35 V
R _{θJC}	— 热阻 (结到壳)	5°C/W
R _{θJA}	— 热阻 (结到空气)	65°C/W
T _{OPR}	— 工作结温范围.....	0~125°C
T _{STG}	— 贮存温度范围.....	-65~150°C

■ 外形图及引脚排列

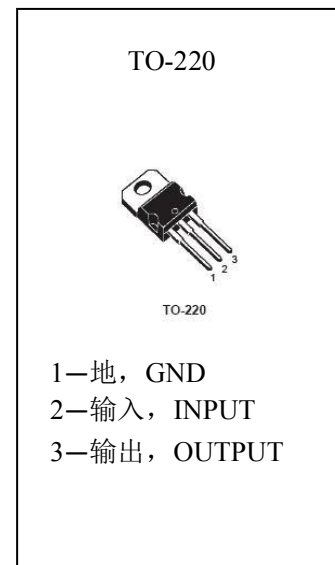

■ 功能框图

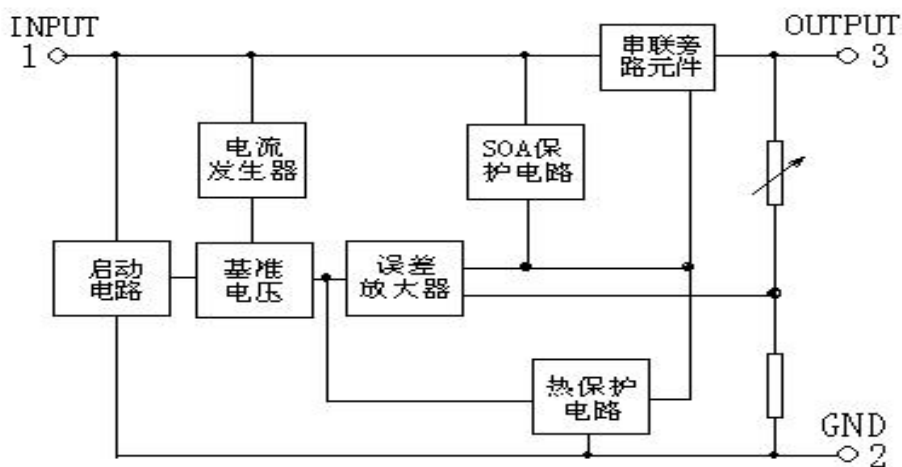

(参见测试电路, 除非另有说明, $0^{\circ}\text{C} \leq T_j \leq 125^{\circ}\text{C}$, $I_0=500\text{mA}$, $V_I=14\text{V}$, $C_I=0.33\mu\text{F}$, $C_O=0.1\mu\text{F}$)

参数符号	符号说明	最小值	典型值	最大值	单位	测试条件
V_O	输出电压	7.7	8.0	8.3	V	$T_j=25^{\circ}\text{C}$
		7.6	8.0	8.4		$5.0\text{mA} \leq I_0 \leq 1.2\text{A}$, $P_0 \leq 15\text{W}$, $10.5\text{V} \leq V_I \leq 23\text{V}$
ΔV_O	电压调整率*		5.0	160	mV	$T_j=25^{\circ}\text{C}$, $10.5\text{V} \leq V_I \leq 25\text{V}$
			2.0	80		$T_j=25^{\circ}\text{C}$, $11.5\text{V} \leq V_I \leq 17\text{V}$
ΔV_O	负载调整率*		10	160	mV	$T_j=25^{\circ}\text{C}$, $5.0\text{mA} \leq I_0 \leq 1.5\text{A}$
			5.0	80		$T_j=25^{\circ}\text{C}$, $250\text{mA} \leq I_0 \leq 750\text{mA}$
I_Q	静态电流		5.0	8	mA	$T_j=25^{\circ}\text{C}$
ΔI_Q	静态电流变化率		0.05	0.5	mA	$5\text{mA} \leq I_0 \leq 1.2\text{A}$
			0.5	1.0		$10.5\text{V} \leq V_I \leq 25\text{V}$
$\Delta V_O / \Delta T$	输出电压温度系数		-0.8		mV/ $^{\circ}\text{C}$	$I_0=5\text{mA}$
V_N	输出噪声电压		52		μV	$T_A=25^{\circ}\text{C}$, $10\text{Hz} \leq f \leq 100\text{kHz}$
RR	纹波抑制比	56	73		dB	$f=120\text{Hz}$, $11.5\text{V} \leq V_I \leq 21.5\text{V}$
V_D	下降电压		2		V	$I_0=1\text{A}$, $T_j=25^{\circ}\text{C}$
R_O	输出阻抗		17		m Ω	$f=1\text{kHz}$
I_{SC}	短路电流		230		mA	$V_I=35\text{V}$, $T_A=25^{\circ}\text{C}$
I_{PK}	峰值电流		2.2		A	$T_j=25^{\circ}\text{C}$

测试电路

图1、DC 参数测试



图2、负载调整率测试



图3、纹波抑制比测试

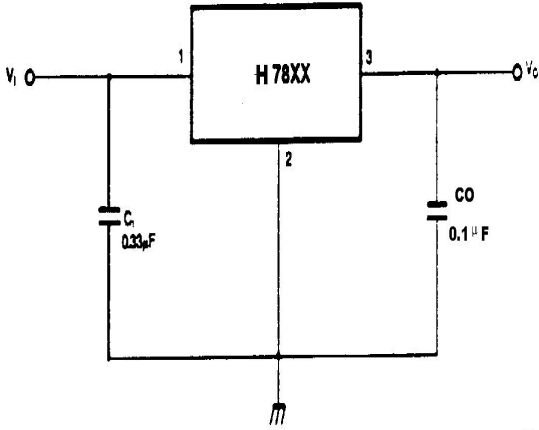

应用电路

图4、固定输出稳压器

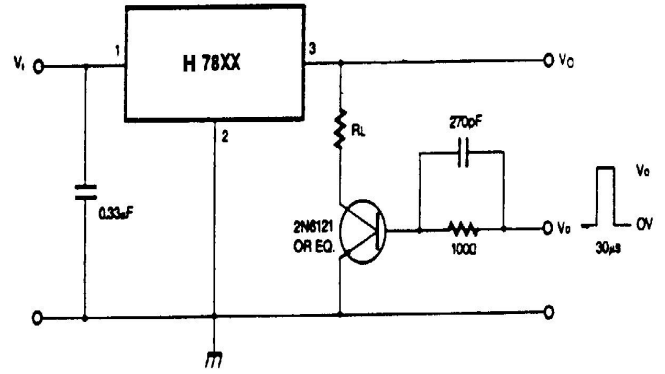
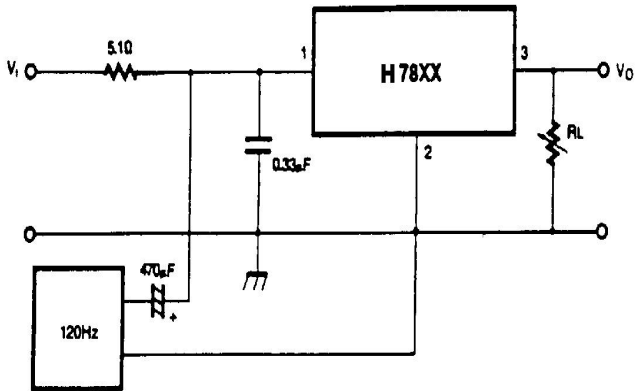

图5、恒流源



$$I_o = \frac{V_{XX}}{R_1} + I_Q$$

图6、提高输出电压电路

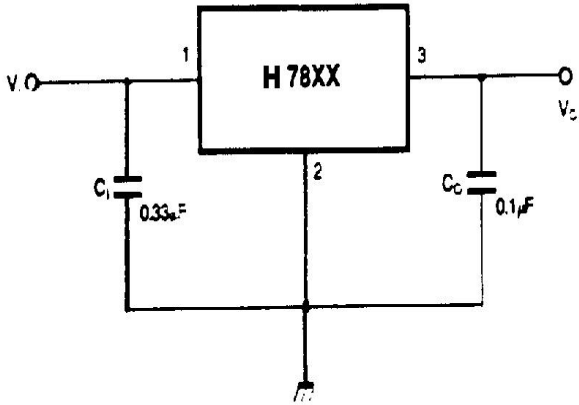
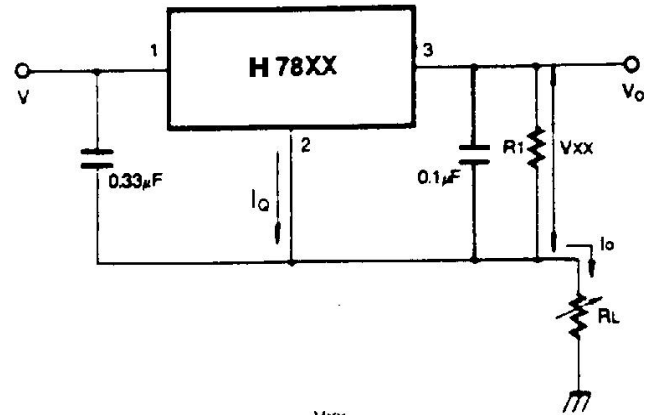
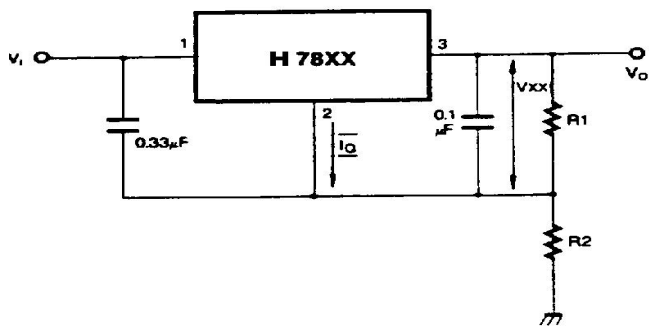

$$I_{R1} \geq 5 I_Q$$

$$V_O = V_{XX} (1 + R_2/R_1) + I_Q R_2$$

- 注:
- 1) 输出电压对应于“XX”值。输入电压，即使是纹波电压中的低值点，都必须高于所需输出电压 2V 以上。
 - 2) 当稳压器远离电源滤波器时，要求用 C1。
 - 3) C0 可改善稳定性和瞬态响应。

应用电路(续)

图7、可调整输出稳压器(7~30V)



图8、大电流稳压器



图9、带短路保护的大电流输出

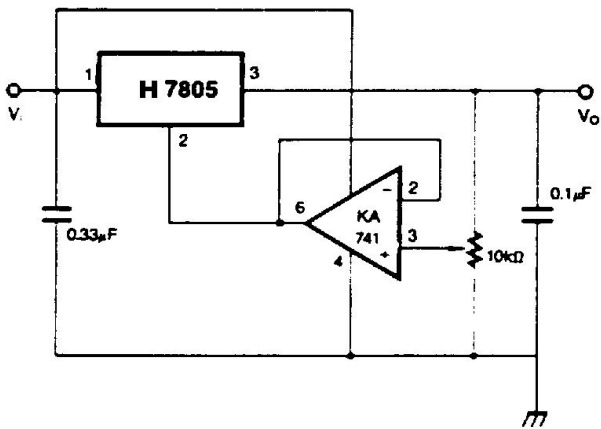

图10、跟踪稳压器

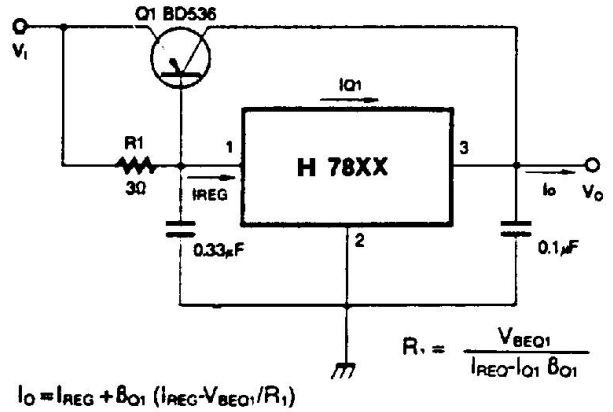

图11、分离电源(±15V-1A)

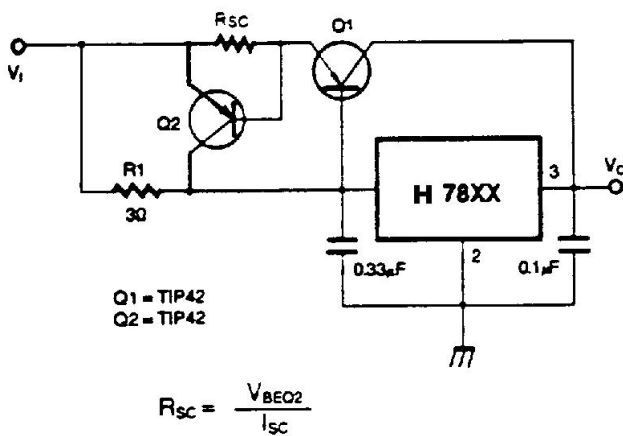

图12、负输出电压电路

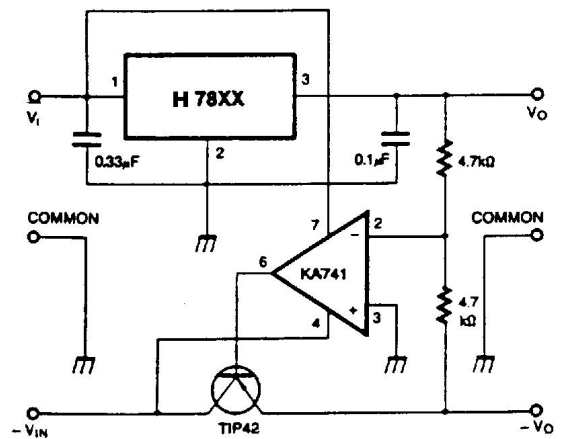

图13、开关稳压器

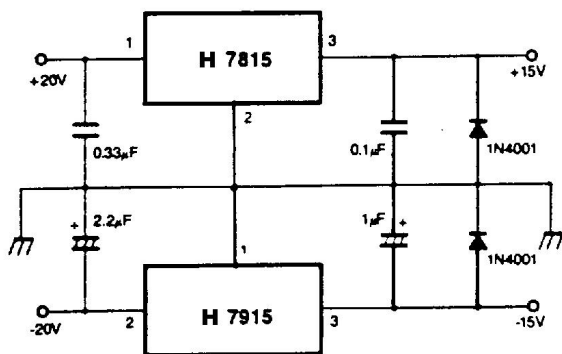

■ 典型特性曲线

静态电流

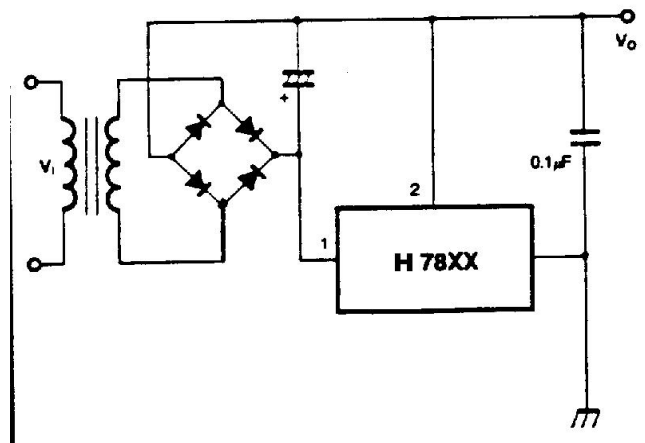
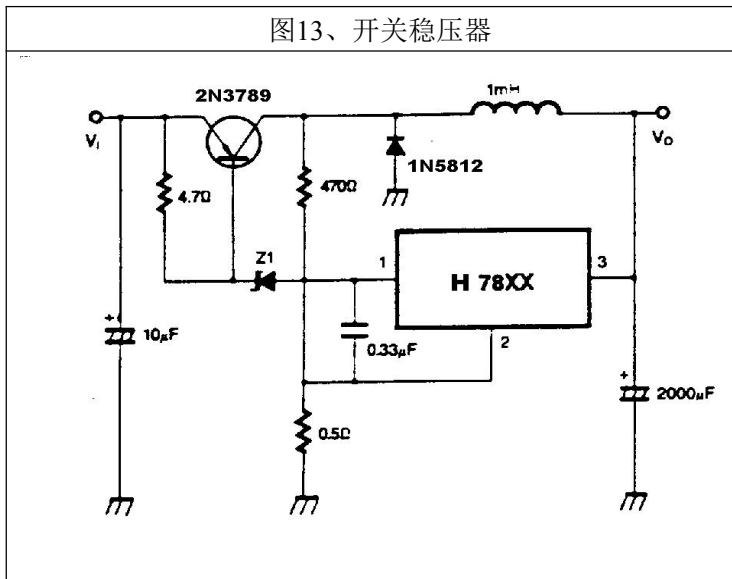
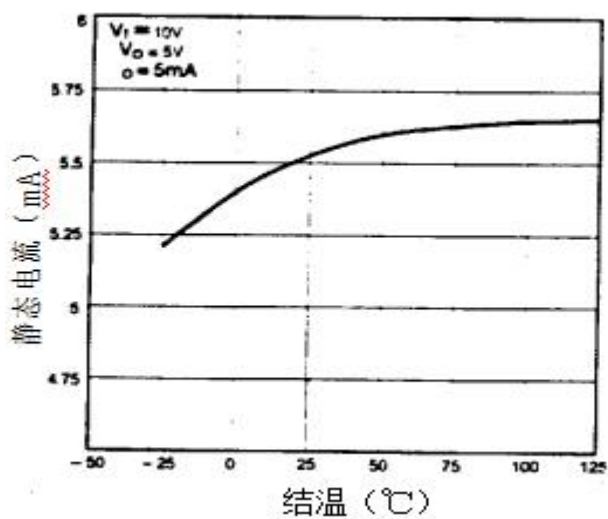

峰值输出电流

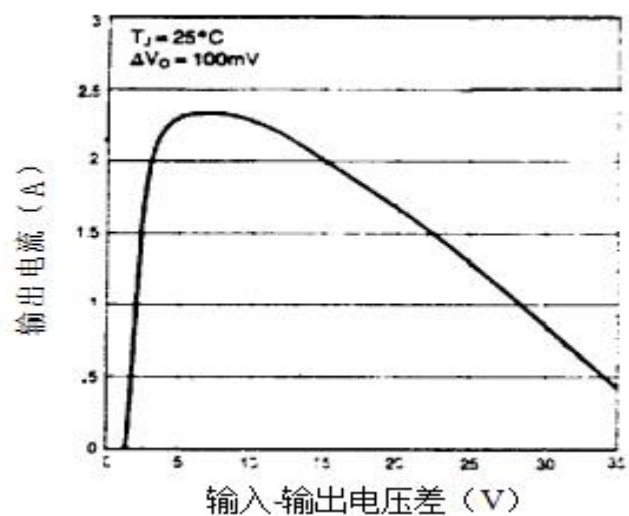

输出电压

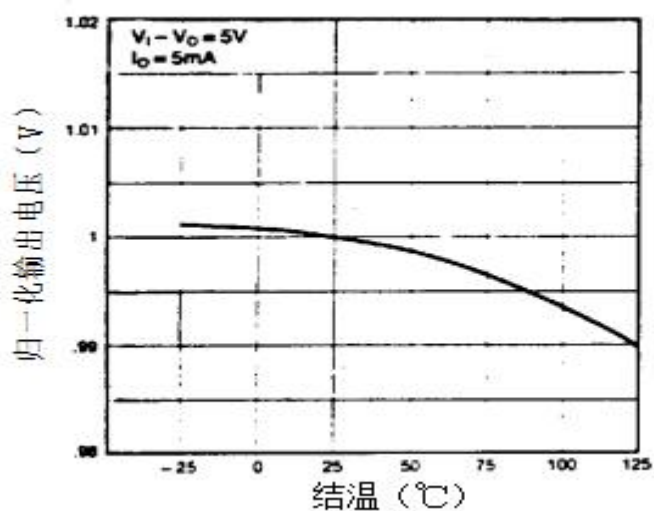

静态电流

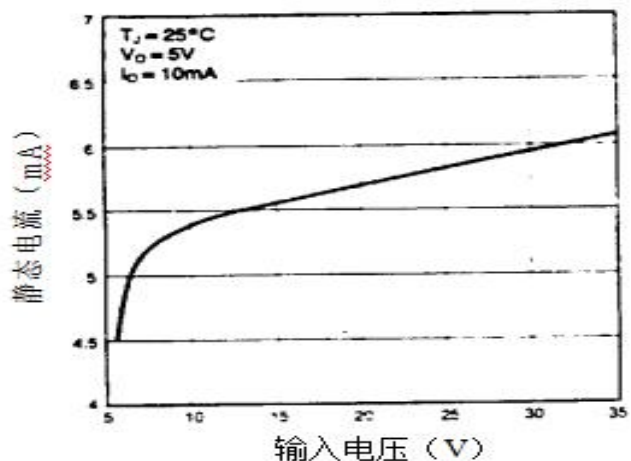



NOTE:

1. Exceeding the maximum ratings of the device in performance may cause damage to the device, even the permanent failure, which may affect the dependability of the machine. Please do not exceed the absolute maximum ratings of the device when circuit designing.
2. When installing the heat sink, please pay attention to the torsional moment and the smoothness of the heat sink.
3. MOSFETs is the device which is sensitive to the static electricity, it is necessary to protect the device from being damaged by the static electricity when using it.
4. Shenzhen Minos reserves the right to make changes in this specification sheet and is subject to change without prior notice.

CONTACT:

深圳市迈诺斯科技有限公司（总部）

地址：深圳市福田区华富街道田面社区深南中路4026号田面城市大厦22B-22C

邮编：518025

电话：0755-83273777

X-ON Electronics

Largest Supplier of Electrical and Electronic Components

Click to view similar products for [LDO Voltage Regulators](#) category:

Click to view products by [Minos](#) manufacturer:

Other Similar products are found below :

[AP7363-SP-13](#) [NCV8664CST33T3G](#) [L79M05TL-E](#) [AP7362-HA-7](#) [PT7M8202B12TA5EX](#) [TCR3DF185,LM\(CT](#) [TLF4949EJ](#)
[NCP4687DH15T1G](#) [NCV8703MX30TCG](#) [LP2951CN](#) [NCV4269CPD50R2G](#) [AP7315-25W5-7](#) [NCV47411PAAJR2G](#) [AP2111H-1.2TRG1](#)
[ZLDO1117QK50TC](#) [AZ1117ID-ADJTRG1](#) [NCV4263-2CPD50R2G](#) [NCP114BMX075TCG](#) [MC33269T-3.5G](#) [TLE4471GXT](#) [AP7315-33SA-](#)
[7](#) [NCV4266-2CST33T3G](#) [NCP715SQ15T2G](#) [NCV8623MN-50R2G](#) [NCV563SQ18T1G](#) [NCV8664CDT33RKG](#) [NCV4299CD250R2G](#)
[NCP715MX30TBG](#) [NCV8702MX25TCG](#) [L974113TR](#) [TLE7270-2E](#) [NCV562SQ25T1G](#) [AP2213D-3.3TRG1](#) [AP2202K-2.6TRE1](#)
[NCV8170BMX300TCG](#) [NCV8152MX300180TCG](#) [NCP700CMT45TBG](#) [AP7315-33W5-7](#) [LD56100DPU28R](#) [NCP154MX180300TAG](#)
[AP2210K-3.0TRE1](#) [AP2113AMTR-G1](#) [NJW4104U2-33A-TE1](#) [MP2013AGG-5-P](#) [NCV8775CDT50RKG](#) [NJM2878F3-45-TE1](#) [S-](#)
[19214B00A-V5T2U7](#) [S-19214B50A-V5T2U7](#) [S-19213B50A-V5T2U7](#) [S-19214BC0A-E8T1U7*1](#)