

60V N-Channel Power MOSFET

DESCRIPTION

The MDT20N06 uses advanced trench technology to provide excellent $R_{DS(ON)}$, low gate charge. It can be used in a wide variety of applications.

Application

- Power switching application
- Hard switched and High frequency circuits
- Uninterruptible power supply

KEY CHARACTERISTICS

- $V_{DS} = 60V, I_D = 20A$
 $R_{DS(ON)} < 30m\Omega @ V_{GS}=10V$
 $R_{DS(ON)} < 40m\Omega @ V_{GS}=4.5V$
- High density cell design for lower R_{dson}
- Fully characterized avalanche voltage and current
- Good stability and uniformity with high EAS
- Excellent package for good heat dissipation

100% UIS TESTED!
100% DVDS TESTED!

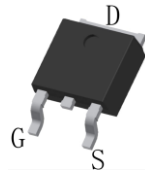

TO-252-2L Top View

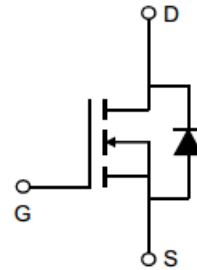

Schematic diagram

Package Marking And Ordering Information

Device Marking	Ordering Codes	Package	Product Code	Packing
20N06	MDT20N06	TO-252	20N06	Reel

Absolute Maximum Ratings ($T_A=25^\circ C$ unless otherwise noted)

Parameter	Symbol	Limit	Unit
Drain-Source Voltage	V_{DS}	60	V
Gate-Source Voltage	V_{GS}	± 20	V
Drain Current-Continuous	I_D	20	A
Drain Current-Pulsed (Note 1)	I_{DM}	80	A
Maximum Power Dissipation($T_c=25^\circ C$)	P_D	44	W
Single pulse avalanche energy (Note 2)	E_{AS}	56	mJ
Operating Junction and Storage Temperature Range	T_J, T_{STG}	-55 To 175	$^\circ C$

Thermal Characteristic

Thermal Resistance, Junction-to-Case	$R_{\theta JC}$	3.4	$^\circ C/W$
--------------------------------------	-----------------	-----	--------------

Electrical Characteristics (TA=25°C unless otherwise noted)

Parameter	Symbol	Condition	Min	Typ	Max	Unit
Off Characteristics						
Drain-Source Breakdown Voltage	BV _{DSS}	V _{GS} =0V I _D =250μA	60	-	-	V
Zero Gate Voltage Drain Current	I _{DSS}	V _{DS} =60V, V _{GS} =0V	-	-	1	μA
Gate-Body Leakage Current	I _{GSS}	V _{GS} =±20V, V _{DS} =0V	-	-	±100	nA
On Characteristics						
Gate Threshold Voltage	V _{GS(th)}	V _{DS} =V _{GS} , I _D =250μA	1.3	1.8	2.3	V
Drain-Source On-State Resistance ^(Note 3)	R _{DS(ON)}	V _{GS} =10V, I _D =10A	-	25	30	mΩ
		V _{GS} =4.5V, I _D =10A	-	30	40	
Forward Transconductance	g _{FS}	V _{DS} =5V, I _D =10A	-	11	-	S
Dynamic Characteristics						
Input Capacitance	C _{ISS}	V _{DS} =25V, V _{GS} =0V, f=1.0MHz	-	670	-	pF
Output Capacitance	C _{OSS}		-	76	-	pF
Reverse Transfer Capacitance	C _{rss}		-	66	-	pF
Switching Characteristics ^(Note 4)						
Turn-on Delay Time	t _{d(on)}	V _{DD} =30V, I _D =10A, V _{GS} =10V, R _{GEN} =10Ω	-	19.2	-	nS
Turn-on Rise Time	t _r		-	6.4	-	nS
Turn-Off Delay Time	t _{d(off)}		-	29.2	-	nS
Turn-Off Fall Time	t _f		-	8.2	-	nS
Total Gate Charge	Q _g	V _{DS} =48V, I _D =10A V _{GS} =10V	-	21	-	nC
Gate-Source Charge	Q _{gs}		-	5	-	nC
Gate-Drain Charge	Q _{gd}		-	6.5	-	nC
Drain-Source Diode Characteristics						
Diode Forward Voltage	V _{SD}	V _{GS} =0V, I _S =20A	-	-	1.2	V
Reverse Recovery Time	T _{rr}	T _j =25°C, I _F =10A, di/dt=100A/uS ^(note3)	-	33.6	-	nS
Reverse Recovery Charge	Q _{rr}		-	32.1	-	nC

Notes:

1. Repetitive Rating: Pulse width limited by maximum junction temperature.
2. E_{AS} condition : T_j=25°C, V_{DD}=30V, V_{GS}=10V, L=0.5mH, R_g=25Ω
3. Pulse Test: Pulse Width ≤ 300μs, Duty Cycle ≤ 2%.
4. Guaranteed by design, not subject to production.

Characteristics Curves

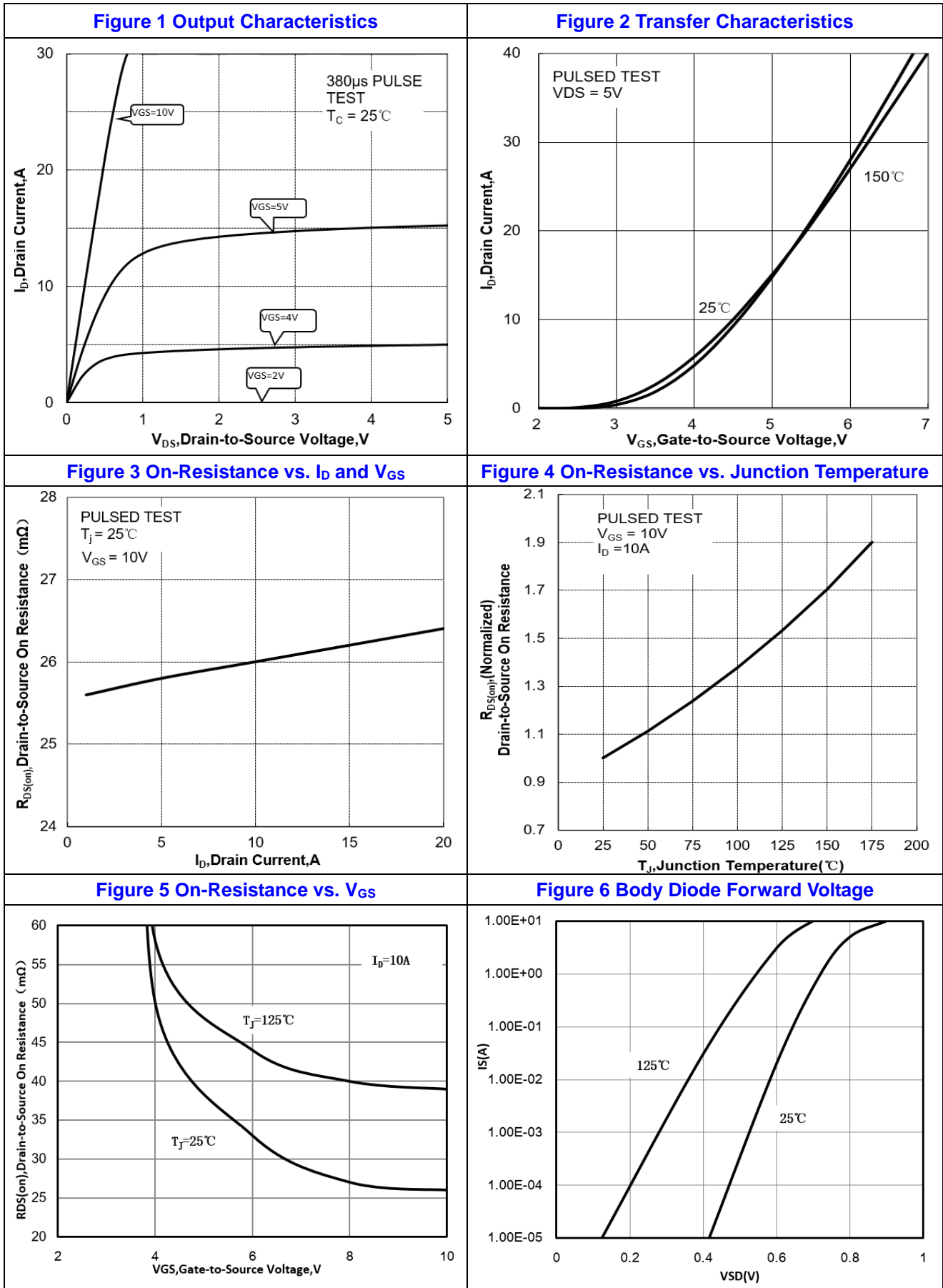

Figure 7 Gate-Charge Characteristics

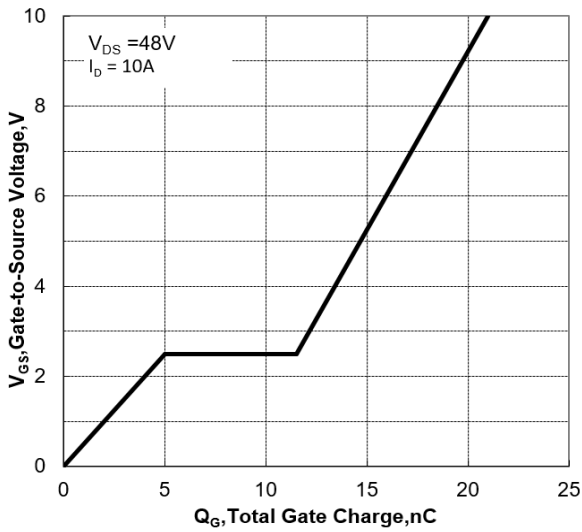

Figure 8 Capacitance Characteristics

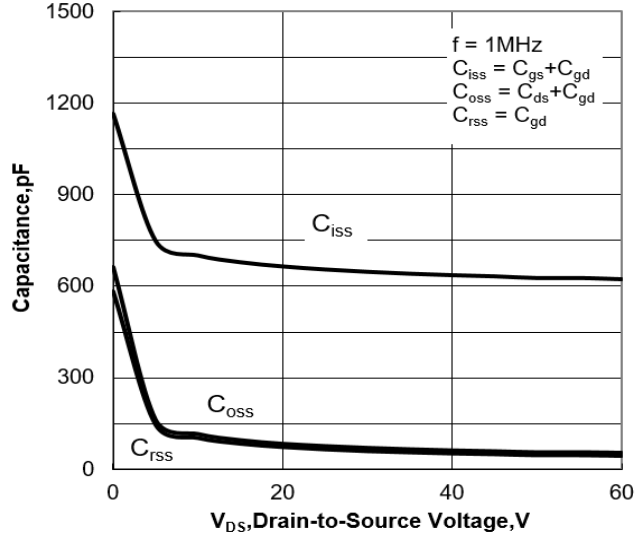

Figure 9 Maximum Forward Biased Safe Operation Area

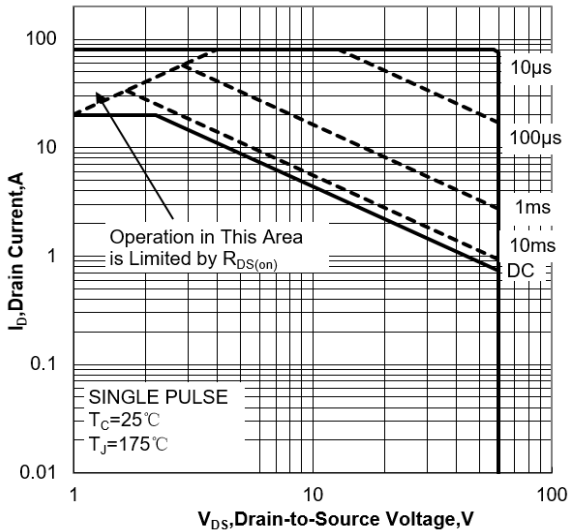

Figure 10 Single Pulse Power Rating Junction-to-Ambient

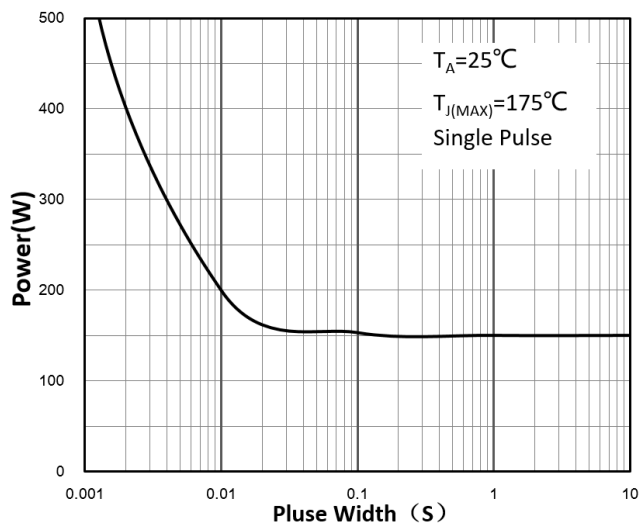
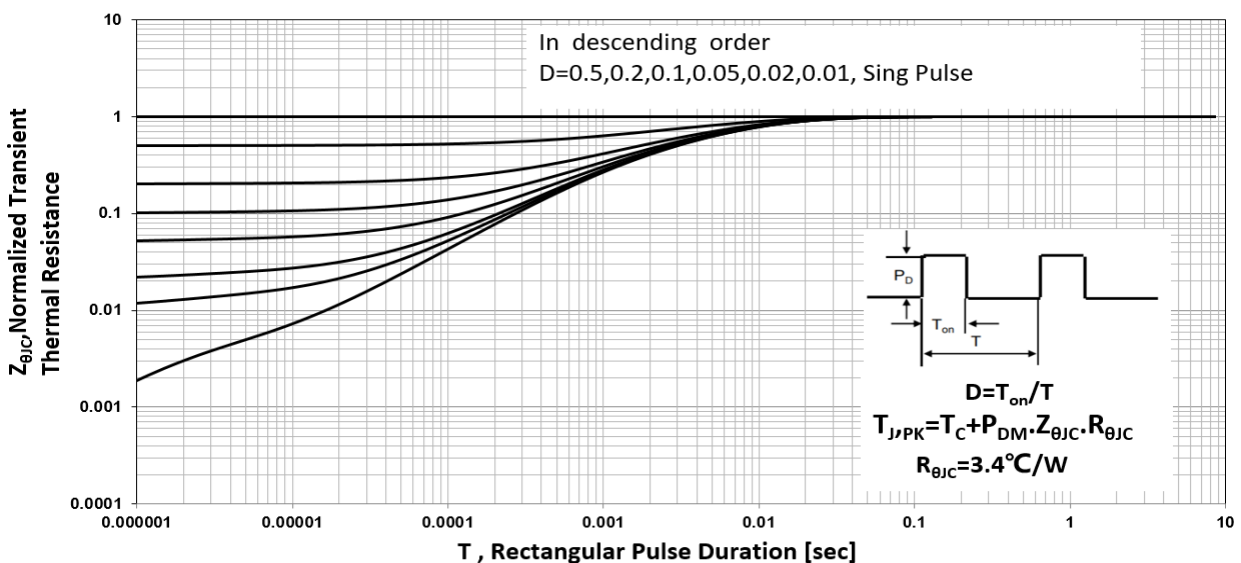

Figure 11 Normalized Maximum Transient Thermal Impedance



Test Circuit and Waveform

Gate Charge Test Circuit	Gate Charge Test Waveform
Resistive Switching Test Circuit	Resistive Switching Test Waveforms
Unclamped Inductive Switching (UIS) Test Circuit	Unclamped Inductive Switching (UIS) Test Waveforms
Diode Recovery Test Circuit	Diode Recovery Test Waveforms

Package Description

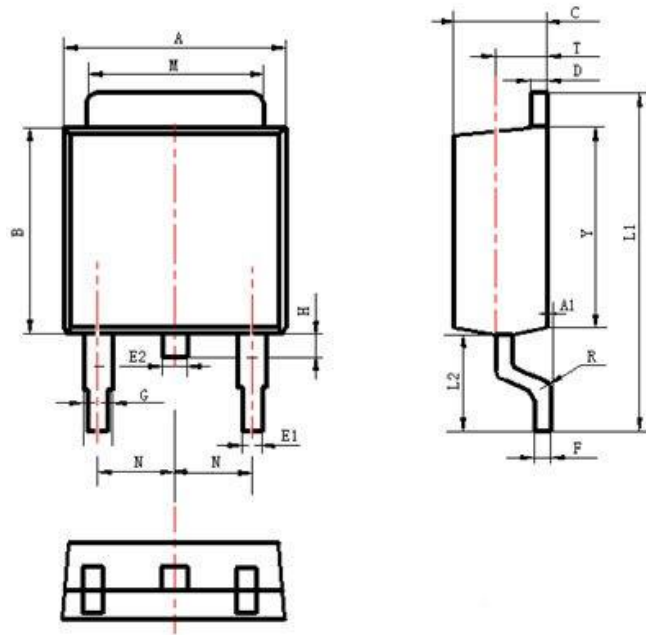

Items	Values(mm)	
	MIN	MAX
A	6.30	6.90
A1	0	0.13
B	5.70	6.30
C	2.10	2.50
D	0.30	0.60
E1	0.60	0.90
E2	0.70	1.00
F	0.30	0.60
G	0.70	1.20
L1	9.60	10.50
L2	2.70	3.10
H	0.60	1.00
M	5.10	5.50
N	2.09	2.49
R	0.3	
T	1.40	1.60
Y	5.10	6.30

TO-252 Package

NOTE:

1. Exceeding the maximum ratings of the device in performance may cause damage to the device, even the permanent failure, which may affect the dependability of the machine. Please do not exceed the absolute maximum ratings of the device when circuit designing.
2. When installing the heat sink, please pay attention to the torsional moment and the smoothness of the heat sink.
3. MOSFETs is the device which is sensitive to the static electricity, it is necessary to protect the device from being damaged by the static electricity when using it.
4. Shenzhen Minos reserves the right to make changes in this specification sheet and is subject to change without prior notice.

CONTACT:

深圳市迈诺斯科技有限公司 (总部)

Address: 深圳市福田区华富街道田面社区深南中路4026号田面城市大厦22B-22C

Phone : 0755-83273777

X-ON Electronics

Largest Supplier of Electrical and Electronic Components

Click to view similar products for [MOSFET](#) category:

Click to view products by [Minos](#) manufacturer:

Other Similar products are found below :

[IRFD120](#) [IRFY240C](#) [JANTX2N5237](#) [2SK2267\(Q\)](#) [BUK455-60A/B](#) [MIC4420CM-TR](#) [VN1206L](#) [NDP4060](#) [SI4482DY](#)
[IPS70R2K0CEAKMA1](#) [SQD23N06-31L-GE3](#) [TK16J60W,S1VQ\(O](#) [2SK2614\(TE16L1,Q\)](#) [DMN1017UCP3-7](#) [EFC2J004NUZTDG](#)
[DMN1053UCP4-7](#) [SQJ469EP-T1-GE3](#) [NTE2384](#) [DMC2700UDMQ-7](#) [DMN2080UCB4-7](#) [DMN61D9UWQ-13](#) [US6M2GTR](#)
[DMN31D5UDJ-7](#) [DMP22D4UFO-7B](#) [DMN1006UCA6-7](#) [DMN16M9UCA6-7](#) [STF5N65M6](#) [IRF40H233XTMA1](#) [STU5N65M6](#)
[DMN6022SSD-13](#) [DMN13M9UCA6-7](#) [DMTH10H4M6SPS-13](#) [DMN2990UFB-7B](#) [IPB80P04P405ATMA2](#) [2N7002W-G](#) [MCAC30N06Y-](#)
[TP](#) [MCQ7328-TP](#) [NTMC083NP10M5L](#) [NVMFS2D3P04M8LT1G](#) [BXP7N65D](#) [BXP4N65F](#) [AOL1454G](#) [WMJ80N60C4](#) [BXP2N20L](#)
[BXP2N65D](#) [BXT1150N10J](#) [BXT1700P06M](#) [TSM60NB380CP](#) [ROG](#) [RQ7L055BGTCR](#) [DMNH15H110SK3-13](#)