

## 60V N-Channel Power MOSFET

### Description

The MDT60N06 uses advanced trench technology to provide excellent  $R_{DS(ON)}$ , low gate charge. It can be used in a wide variety of applications.

### General Features

- ①  $V_{DS}=60V$ ,  $R_{Dson}<15m\Omega$  @ $V_{GS}=10V$ ,  $I_D=60A$  (Typ:12m $\Omega$ )
- ② High density cell design for lower  $R_{dson}$
- ③ Fully characterized avalanche voltage and current
- ④ Good stability and uniformity with high EAS
- ⑤ Excellent package for good heat dissipation

### Application

- ① Power Switching application
- ② Hard switched and High frequency circuits
- ③ Uninterruptible power supply

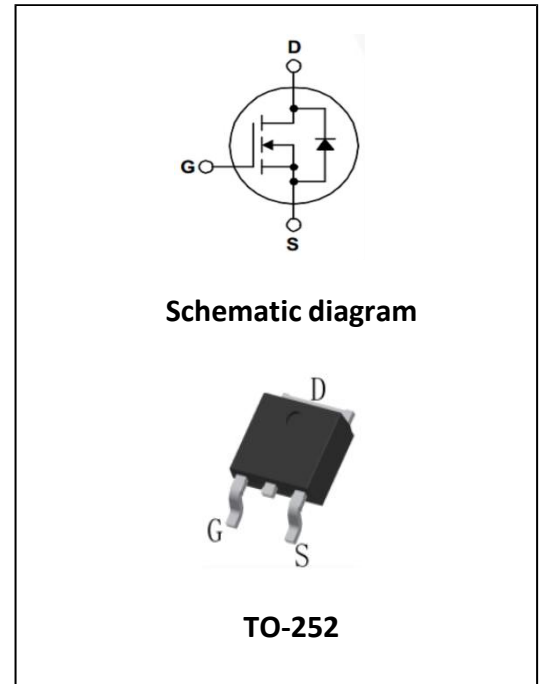

### Package Marking And Ordering Information:

Ordering Codes	Package	Product Code	Packing
MDT60N06-D	TO-252	MDT60N06	Tube

### Electrical Characteristics @ $T_a=25^\circ C$ (unless otherwise specified)

Parameter	Symbol	Limit	Unit
Drain-Source Voltage	$V_{DS}$	60	V
Gate-Source Voltage	$V_{GS}$	$\pm 20$	V
Drain Current-Continuous	$I_D$	60	A
Drain Current-Pulsed (Note 1)	$I_{DM}$	200	A
Maximum Power Dissipation( $T_c=25^\circ C$ )	$P_D$	87	W
Single pulse avalanche energy (Note 2)	$E_{AS}$	120	mJ
Operating Junction and Storage Temperature Range	$T_J, T_{STG}$	-55 To 175	$^\circ C$

### Thermal Characteristic

Thermal Resistance, Junction-to-Case	$R_{\theta JC}$	1.72	$^\circ C/W$
--------------------------------------	-----------------	------	--------------

Electrical Characteristics (TA=25°C unless otherwise noted)

Parameter	Symbol	Condition	Min	Typ	Max	Unit
<b>Off Characteristics</b>						
Drain-Source Breakdown Voltage	BV <sub>DSS</sub>	V <sub>GS</sub> =0V, I <sub>D</sub> =250μA	60	-	-	V
Zero Gate Voltage Drain Current	I <sub>DSS</sub>	V <sub>DS</sub> =60V, V <sub>GS</sub> =0V	-	-	1	μA
Gate-Body Leakage Current	I <sub>GSS</sub>	V <sub>GS</sub> =±20V, V <sub>DS</sub> =0V	-	-	±100	nA
<b>On Characteristics</b>						
Gate Threshold Voltage	V <sub>GS(th)</sub>	V <sub>DS</sub> =V <sub>GS</sub> , I <sub>D</sub> =250μA	2	3	4	V
Drain-Source On-State Resistance <sup>(Note 3)</sup>	R <sub>DS(ON)</sub>	V <sub>GS</sub> =10V, I <sub>D</sub> =25A	-	12	15	mΩ
Forward Transconductance	g <sub>FS</sub>	V <sub>DS</sub> =25V, I <sub>D</sub> =25A	-	25	-	S
<b>Dynamic Characteristics</b>						
Input Capacitance	C <sub>iss</sub>	V <sub>DS</sub> =25V, V <sub>GS</sub> =0V, f=1.0MHz	-	910	-	pF
Output Capacitance	C <sub>oss</sub>		-	100	-	pF
Reverse Transfer Capacitance	C <sub>rss</sub>		-	30	-	pF
<b>Switching Characteristics</b> <sup>(Note 4)</sup>						
Turn-on Delay Time	t <sub>d(on)</sub>	V <sub>DD</sub> =30V, I <sub>D</sub> =20A, V <sub>GS</sub> =10V, R <sub>GEN</sub> =5Ω	-	26	-	nS
Turn-on Rise Time	t <sub>r</sub>		-	6	-	nS
Turn-Off Delay Time	t <sub>d(off)</sub>		-	52	-	nS
Turn-Off Fall Time	t <sub>f</sub>		-	7	-	nS
Total Gate Charge	Q <sub>g</sub>	V <sub>DS</sub> =30V, I <sub>D</sub> =50A V <sub>GS</sub> =10V	-	31	-	nC
Gate-Source Charge	Q <sub>gs</sub>		-	9	-	nC
Gate-Drain Charge	Q <sub>gd</sub>		-	5	-	nC
<b>Drain-Source Diode Characteristics</b>						
Diode Forward Voltage	V <sub>SD</sub>	V <sub>GS</sub> =0V, I <sub>S</sub> =50A	-	-	1.2	V

Notes:

Repetitive Rating: Pulse width limited by maximum junction temperature.

EAS condition : T<sub>j</sub>=25°C, V<sub>DD</sub>=30V, V<sub>GS</sub>=10V, L=0.5mH, R<sub>g</sub>=25Ω

Pulse Test: Pulse Width ≤ 300μs, Duty Cycle ≤ 2%.

Guaranteed by design, not subject to production.

Characteristics Curves

Figure 1 Output Characteristics

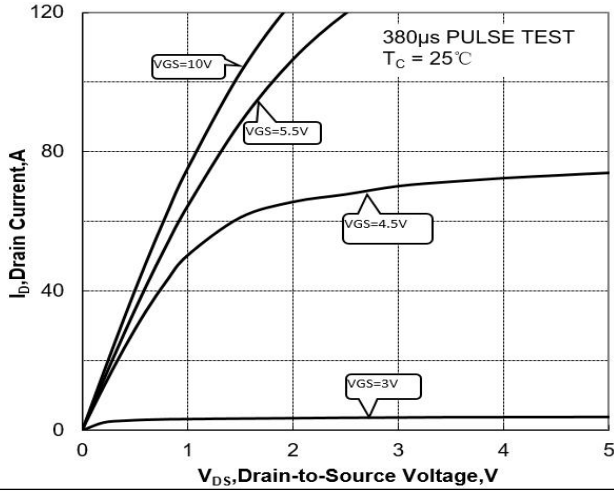

Figure 2 Transfer Characteristics

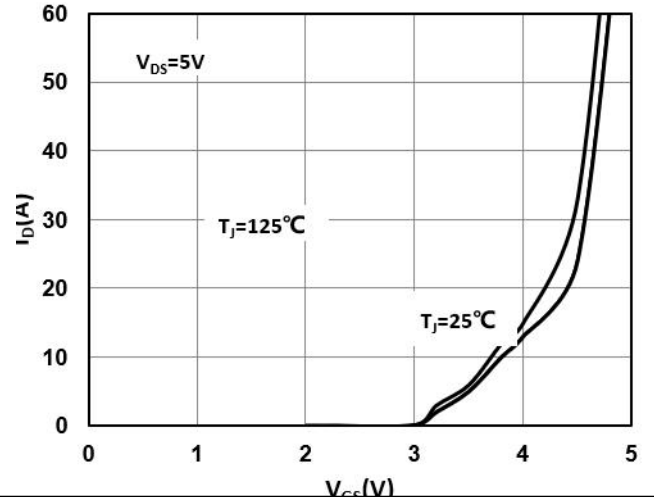

Figure 3 On-Resistance vs. ID and VGS

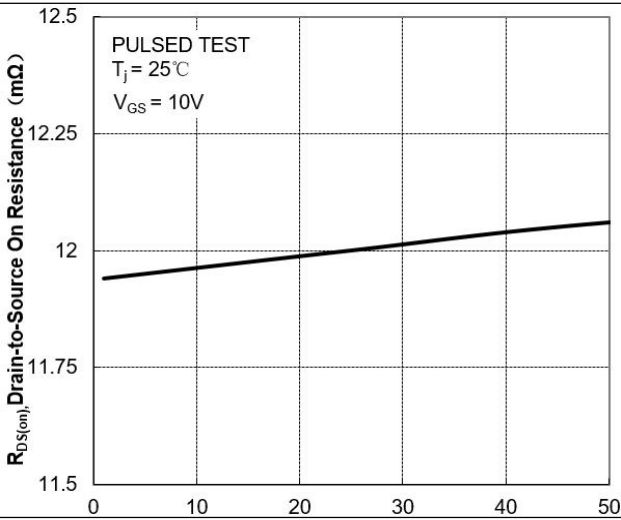

Figure 4 On-Resistance vs. Junction Temperature

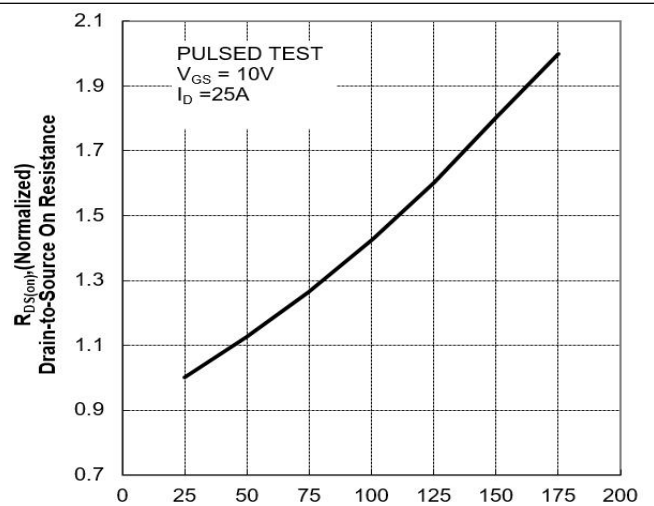

Figure 5 On-Resistance vs. VGS

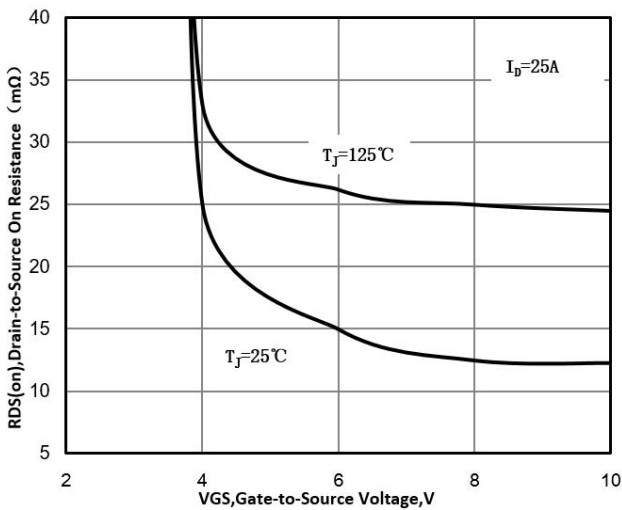

Figure 6 Body Diode Forward Voltage

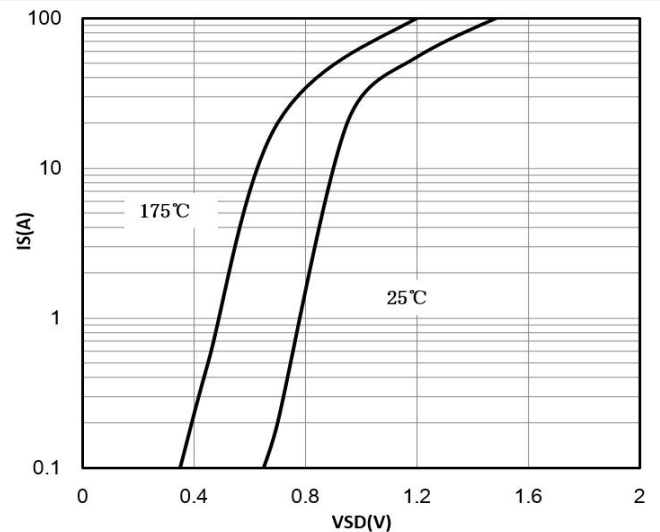

Figure 7 Gate-Charge Characteristics

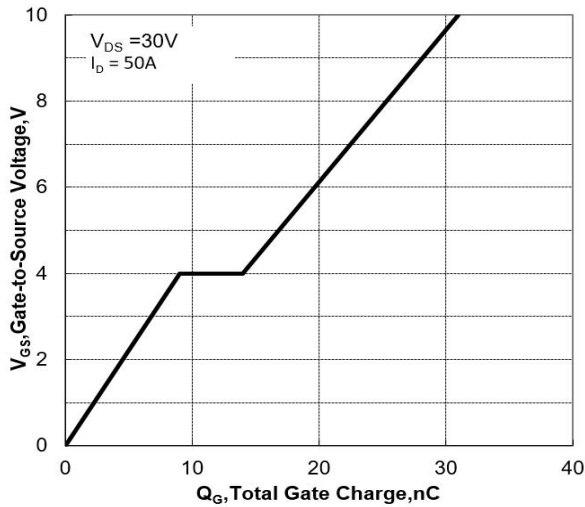

Figure 8 Capacitance Characteristics

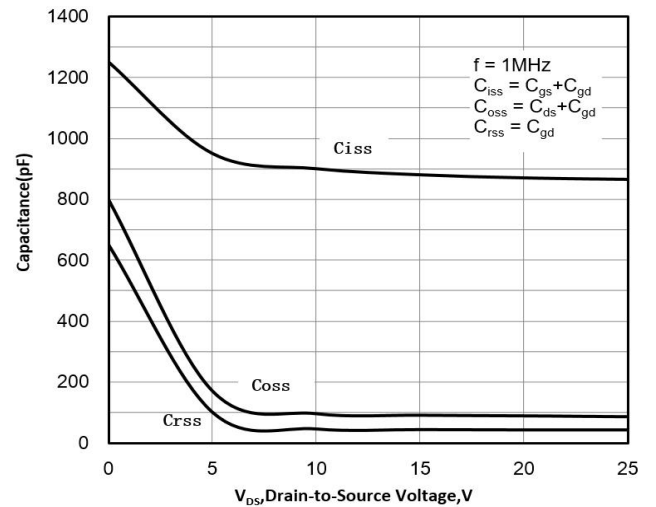

Figure 9 Maximum Forward Biased Safe Operation Area

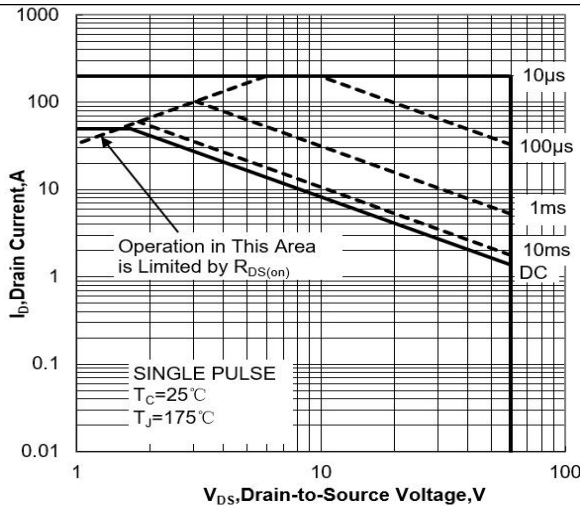

Figure 10 Single Pulse Power Rating Junction-to-Ambient

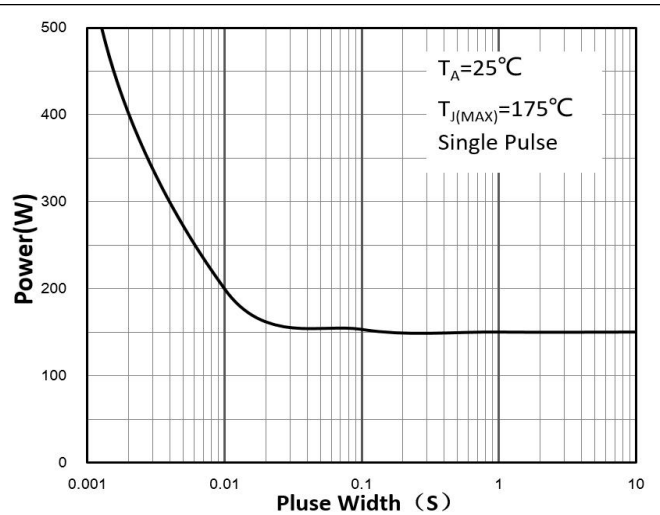
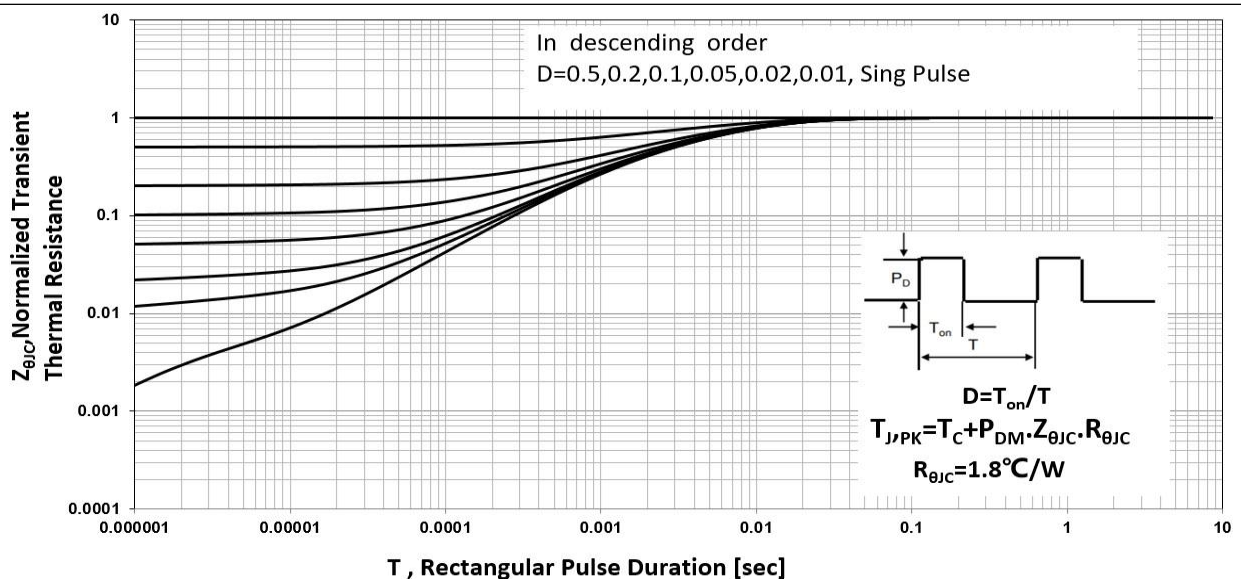
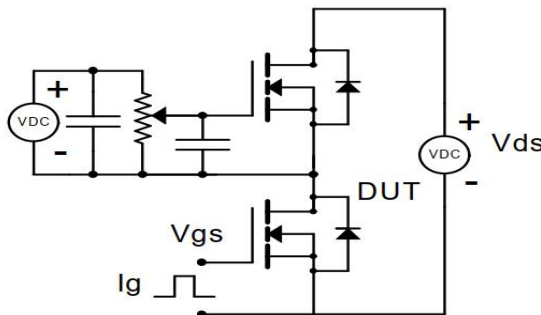
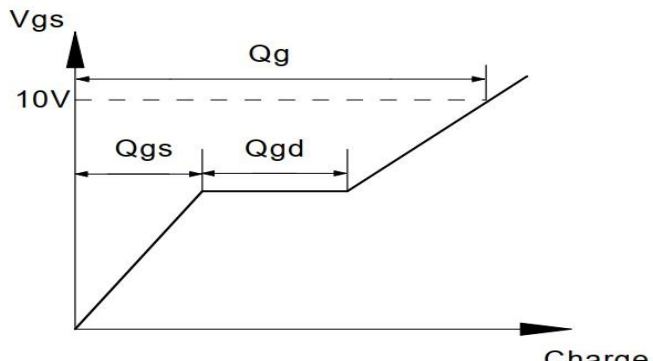
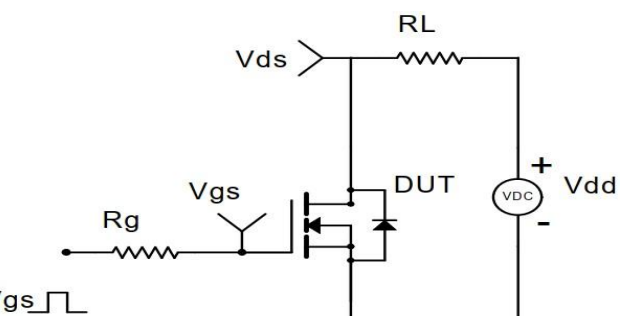
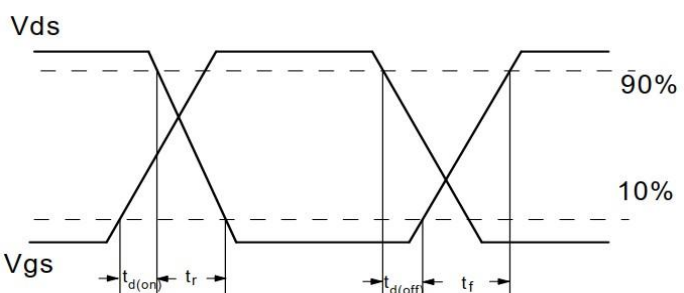
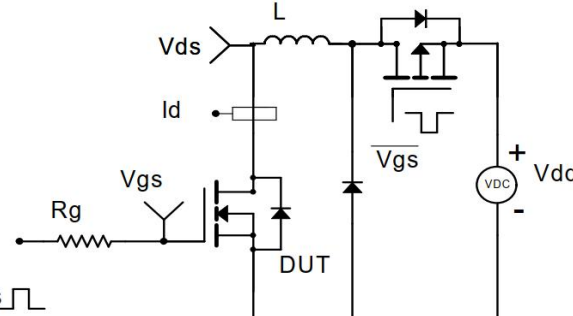
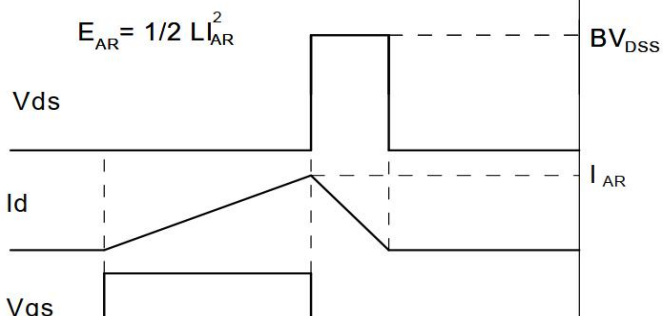
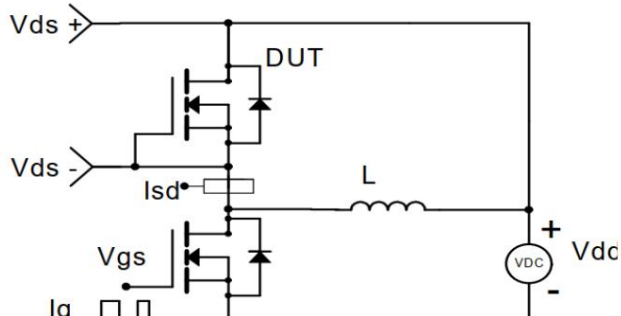
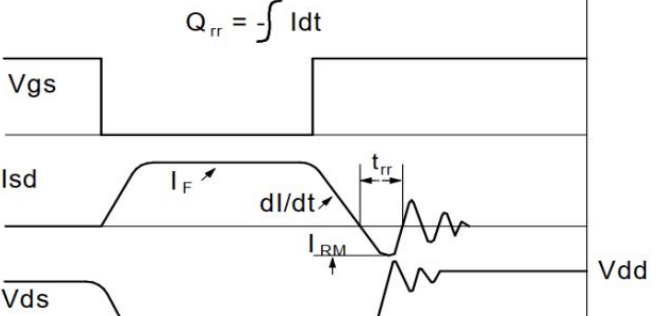

Figure 11 Normalized Maximum Transient Thermal Impedance



Test Circuit and Waveform

<p style="text-align: center;"><b>Gate Charge Test Circuit</b></p> 	<p style="text-align: center;"><b>Gate Charge Test Waveform</b></p> 
<p style="text-align: center;"><b>Resistive Switching Test Circuit</b></p> 	<p style="text-align: center;"><b>Resistive Switching Test Waveforms</b></p> 
<p style="text-align: center;"><b>Unclamped Inductive Switching (UIS) Test Circuit</b></p> 	<p style="text-align: center;"><b>Unclamped Inductive Switching (UIS) Test Waveforms</b></p> 
<p style="text-align: center;"><b>Diode Recovery Test Circuit</b></p> 	<p style="text-align: center;"><b>Diode Recovery Test Waveforms</b></p> 

Package Description

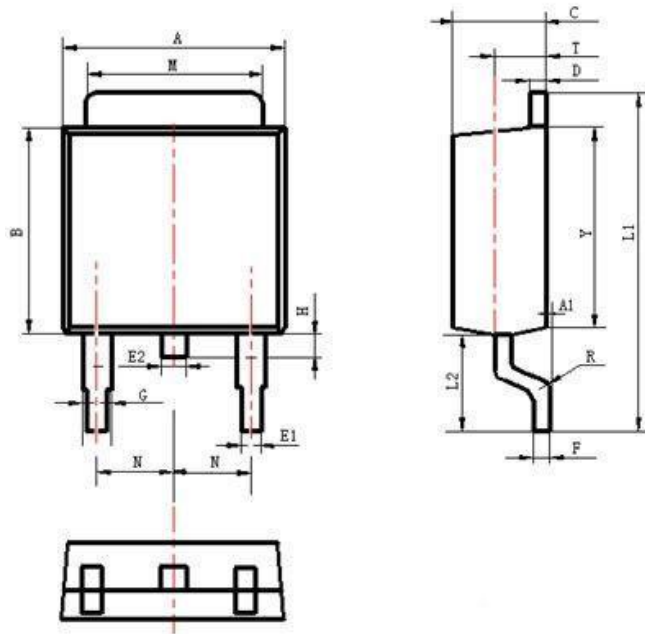

Items	Values (mm)	
	MIN	MAX
A	6.30	6.90
A1	0	0.13
B	5.70	6.30
C	2.10	2.50
D	0.30	0.60
E1	0.60	0.90
E2	0.70	1.00
F	0.30	0.60
G	0.70	1.20
L1	9.60	10.50
L2	2.70	3.10
H	0.60	1.00
M	5.10	5.50
N	2.09	2.49
R	0.3	
T	1.40	1.60
Y	5.10	6.30

TO-252 Package



**NOTE:**

1. Exceeding the maximum ratings of the device in performance may cause damage to the device, even the permanent failure, which may affect the dependability of the machine. Please do not exceed the absolute maximum ratings of the device when circuit designing.
2. When installing the heat sink, please pay attention to the torsional moment and the smoothness of the heat sink.
3. MOSFETs is the device which is sensitive to the static electricity, it is necessary to protect the device from being damaged by the static electricity when using it.
4. Shenzhen Minos reserves the right to make changes in this specification sheet and is subject to change without prior notice.

**CONTACT:**

**深圳市迈诺斯科技有限公司（总部）**

地址：深圳市福田区华富街道田面社区深南中路4026号田面城市大厦22B-22C

邮编：518025

电话：0755-83273777

## X-ON Electronics

Largest Supplier of Electrical and Electronic Components

*Click to view similar products for [MOSFET](#) category:*

*Click to view products by [Minos](#) manufacturer:*

Other Similar products are found below :

[IRFD120](#) [IRFY240C](#) [JANTX2N5237](#) [2SK2267\(Q\)](#) [BUK455-60A/B](#) [MIC4420CM-TR](#) [VN1206L](#) [NDP4060](#) [SI4482DY](#)  
[IPS70R2K0CEAKMA1](#) [SQD23N06-31L-GE3](#) [TK16J60W,S1VQ\(O](#) [2SK2614\(TE16L1,Q\)](#) [DMN1017UCP3-7](#) [EFC2J004NUZTDG](#)  
[DMN1053UCP4-7](#) [SQJ469EP-T1-GE3](#) [NTE2384](#) [DMC2700UDMQ-7](#) [DMN2080UCB4-7](#) [DMN61D9UWQ-13](#) [US6M2GTR](#)  
[DMN31D5UDJ-7](#) [DMP22D4UFO-7B](#) [DMN1006UCA6-7](#) [DMN16M9UCA6-7](#) [STF5N65M6](#) [IRF40H233XTMA1](#) [STU5N65M6](#)  
[DMN6022SSD-13](#) [DMN13M9UCA6-7](#) [DMTH10H4M6SPS-13](#) [DMN2990UFB-7B](#) [IPB80P04P405ATMA2](#) [2N7002W-G](#) [MCAC30N06Y-](#)  
[TP](#) [MCQ7328-TP](#) [NTMC083NP10M5L](#) [NVMFS2D3P04M8LT1G](#) [BXP7N65D](#) [BXP4N65F](#) [AOL1454G](#) [WMJ80N60C4](#) [BXP2N20L](#)  
[BXP2N65D](#) [BXT1150N10J](#) [BXT1700P06M](#) [TSM60NB380CP](#) [ROG](#) [RQ7L055BGTCR](#) [DMNH15H110SK3-13](#)