

Description

MLG40N65FUK is obtained by advanced Trench Field Stop (T-FS) technology which is characteristic with low $V_{CE(sat)}$, optimized switching performance and low gate charge Q_g . The IGBT is suitable device for welding, UPS, and high switching frequency applications.

KEY CHARACTERISTICS

Parameter	Value	Unit
V_{CES}	650	V
I_C	40	A
$V_{CE(sat).typ}$	1.55	V

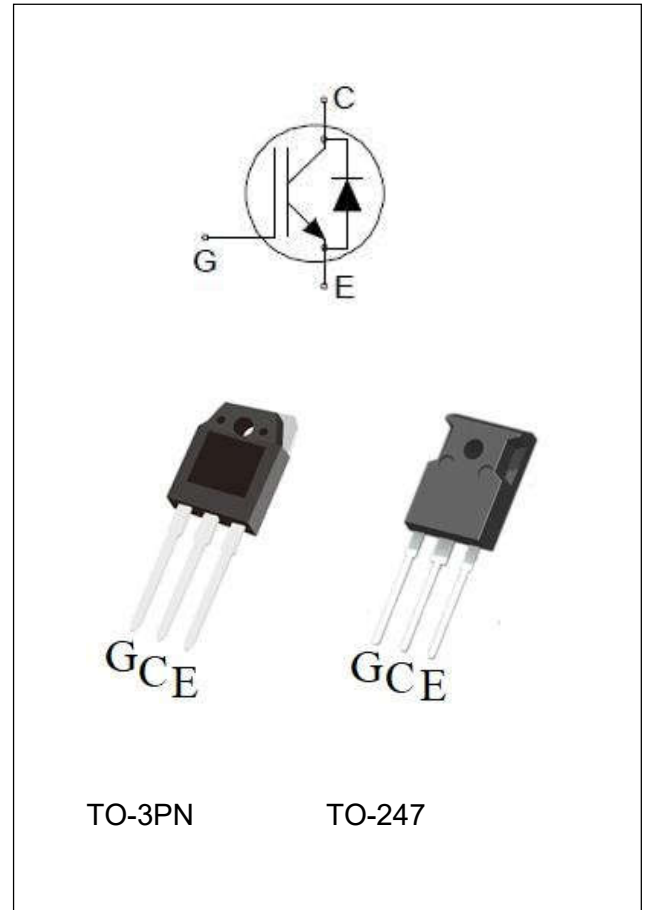

FEATURES

- ① Fast Switching
- ② Low $V_{CE(sat)}$
- ③ Positive temperature coefficient
- ④ Fast recovery anti-parallel diode
- ⑤ RoHS product

APPLICATIONS

- ① Welding converters
- ② UPS
- ③ Boost Chopper
- ④ Air condition

Package Marking And Ordering Information:

Ordering Codes	Package	Product Code	Packing
MLG40N65FUK-W	TO-3PN	G40N65FUK	Tube
MLG40N65FUK-F	TO-247	G40N65FUK	Tube

ABSOLUTE RATINGS

Symbol	Parameter	Values	Units
V_{CES}	Collector-Emitter Voltage	650	V
I_C	Collector Current @TC=25°C	80	A
	Collector Current @TC=100°C	40	A
I_{CM}	Pulsed Collector Current, tp limited by T_{Jmax}	160	A
I_F	Diode Continuous Forward Current @TC=25°C	40	A
	Diode Continuous Forward Current @TC=100°C	20	A
I_{FM}	Diode Maximum Forward Current, limited by T_{Jmax}	80	A
V_{GES}	Gate-Emitter Voltage	±30	V
t_{SC}	Short circuit withstand time $V_{GE}=15V$, $V_{CC} \leq 400V$, Allowed number of short circuits < 1000, Times between short circuits: ≥	3.0	μs
P_D	Power Dissipation @TC=25°C	298	W
$T_{Jmax, Tstg}$	Operating Junction and Storage Temperature Range	175, -55 to 175	°C
T_L	Maximum Temperature for Soldering	260	°C

Thermal characteristics

Symbol	Parameter	Values	Units
$R_{\theta JC}$	Junction-to-Case (IGBT)	0.5	°C/W
$R_{\theta JC}$	Junction-to-Case (Diode)	0.8	°C/W
$R_{\theta JA}$	Junction-to-Ambient	40	°C/W

Electrical Characteristics, at TC = 25°C, unless otherwise specified

Static Characteristics

Symbol	Parameter	Test Conditions	Values			Units
			Min.	Typ.	Max.	
V_{CES}	Collector-Emitter Breakdown Voltage	$V_{GE}=0V$, $I_C=250\mu A$	650	--	--	V
$V_{CE(sat)}$	Collector-Emitter Saturation Voltage	$V_{GE}=15V$, $I_C=40A$	--	1.55	1.95	V
		$T_J=25^\circ C$	--	1.80	--	
		$T_J=125^\circ C$	--	1.90	--	
$V_{GE(TH)}$	Gate Threshold Voltage	$V_{CE}=V_{GE}, I_C=1mA$	4.8	5.5	6.2	V

V_F	Diode Forward Voltage	$I_F=20A$ $T_J=25^\circ C$ $T_J=125^\circ C$ $T_J=175^\circ C$	-- -- --	2.20 1.80 1.52	2.80 -- --	V
V_F	Diode Forward Voltage	$I_F=40A$ $T_J=25^\circ C$ $T_J=125^\circ C$ $T_J=175^\circ C$	-- -- --	2.60 2.25 1.95	3.20 -- --	V
I_{CES}	Collector-Emitter Leakage Current	$V_{CE}=650V$, $V_{GE}=0V$	--	--	4	μA
$I_{GES(F)}$	Gate-Emitter Forward Leakage Current	$V_{GE}=+30V$	--	--	200	nA
$I_{GES(R)}$	Gate-Emitter Reverse Leakage Current	$V_{GE}=-30V$	--	--	-200	nA
Pulse width $t_p \leq 300\mu s$, $\delta \leq 2\%$						

Dynamic Characteristics

Symbol	Parameter	Test Conditions	Values			Units
			Min.	Typ.	Max.	
C_{iss}	Input Capacitance	$V_{GE}=0V$ $V_{CE}=25V$ $f=1.0MHz$	--	2225	--	pF
C_{oss}	Output Capacitance		--	90	--	
C_{rss}	Reverse Transfer Capacitance		--	27	--	
Q_G	Gate charge	$V_{CC}=520V$ $I_{CE}=20A$ $V_{GE}=15V$	--	110	--	nC
Q_{GE}	Gate-emitter charge		--	52	--	
Q_{GC}	Gate-collector charge		--	23	--	
$I_{C(SC)}$	Short circuit collector current Max.1000 short circuits, Times between short circuits: $\geq 1.0s$	$V_{GE}=15.0V$, $V_{CC} \leq 400V$, $t_{SC} \leq 3\mu s$, $T_J \leq 175^\circ C$		320		A

IGBT Switching Characteristics, at $T_J=25^\circ C$

Symbol	Parameter	Test Conditions	Values			Units
			Min.	Typ.	Max.	
$t_{d(on)}$	Turn-on Delay Time	$I_C=40A$ $V_{CE}=400V$ $V_{GE}=15V$ $R_G=5\Omega$ $T_J=25^\circ C$ Inductive Load	--	19	--	ns
t_r	Rise Time		--	35	--	
$t_{d(off)}$	Turn-Off Delay Time		--	90	--	
t_f	Fall Time		--	26	--	mJ
E_{on}	Turn-On Switching Loss		--	0.60	--	
E_{off}	Turn-Off Switching Loss		--	0.38	--	
E_{ts}	Total Switching Loss		--	0.98	--	

IGBT Switching Characteristics, at $T_J=175^\circ\text{C}$

Symbol	Parameter	Test Conditions	Values			Units
			Min.	Typ.	Max.	
$t_{d(on)}$	Turn-on Delay Time	$I_C=40\text{A}$ $V_{CE}=400\text{V}$ $V_{GE}=15\text{V}$ $R_G=5\Omega$ $T_J=175^\circ\text{C}$ Inductive Load	--	17	--	ns
t_r	Rise Time		--	32	--	
$t_{d(off)}$	Turn-Off Delay Time		--	142	--	
t_f	Fall Time		--	36	--	
E_{on}	Turn-On Switching Loss		--	0.8	--	mJ
E_{off}	Turn-Off Switching Loss		--	0.65	--	
E_{ts}	Total Switching Loss		--	1.45	--	

Diode Characteristics, at $T_J=25^\circ\text{C}$

Symbol	Parameter	Test Conditions	Values			Units
			Min.	Typ.	Max.	
T_{rr}	Reverse Recovery Time	$I_F=20\text{A}$, $di/dt=200\text{A}/\mu\text{s}$, $T_J=25^\circ\text{C}$	--	97	--	ns
Q_{rr}	Reverse Recovery Charge		--	109	--	nC
I_{rrm}	Reverse Recovery Current		--	1.8	--	A
T_{rr}	Reverse Recovery Time	$I_F=40\text{A}$, $di/dt=200\text{A}/\mu\text{s}$, $T_J=25^\circ\text{C}$	--	127	--	ns
Q_{rr}	Reverse Recovery Charge		--	326	--	nC
I_{rrm}	Reverse Recovery Current		--	4.8	--	A

Diode Characteristics, at $T_J=175^\circ\text{C}$

Symbol	Parameter	Test Conditions	Values			Units
			Min.	Typ.	Max.	
T_{rr}	Reverse Recovery Time	$I_F=20\text{A}$, $di/dt=200\text{A}/\mu\text{s}$, $T_J=175^\circ\text{C}$	--	147	--	ns
Q_{rr}	Reverse Recovery Charge		--	742	--	nC
I_{rrm}	Reverse Recovery Current		--	7.8	--	A
T_{rr}	Reverse Recovery Time	$I_F=40\text{A}$, $di/dt=200\text{A}/\mu\text{s}$, $T_J=175^\circ\text{C}$	--	158	--	ns
Q_{rr}	Reverse Recovery Charge		--	870	--	nC
I_{rrm}	Reverse Recovery Current		--	9	--	A

Characteristics Curves

Figure 1. Forward Bias Safe Operating Area for TO3PN/TO247

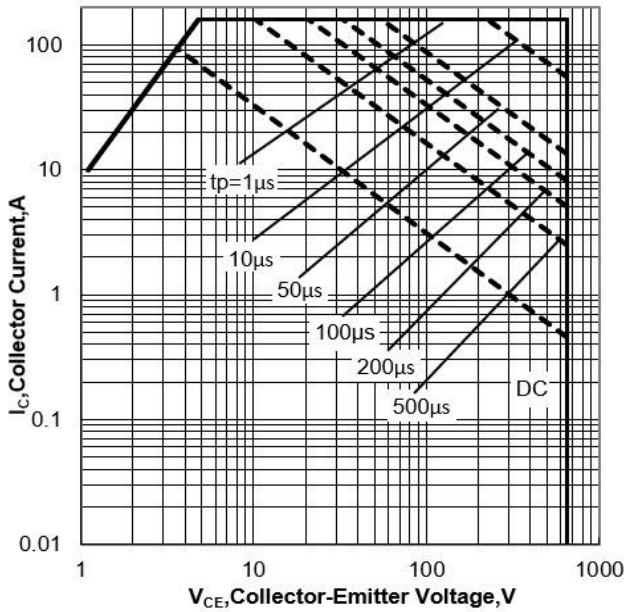

Figure 2. Power Dissipation vs Case Temperature for TO3PN/TO247

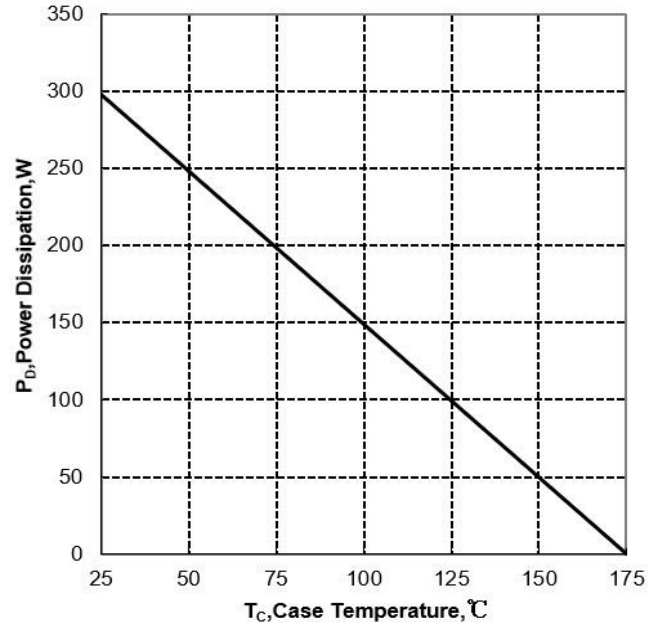

Figure 3. Collector Current vs Case Temperature

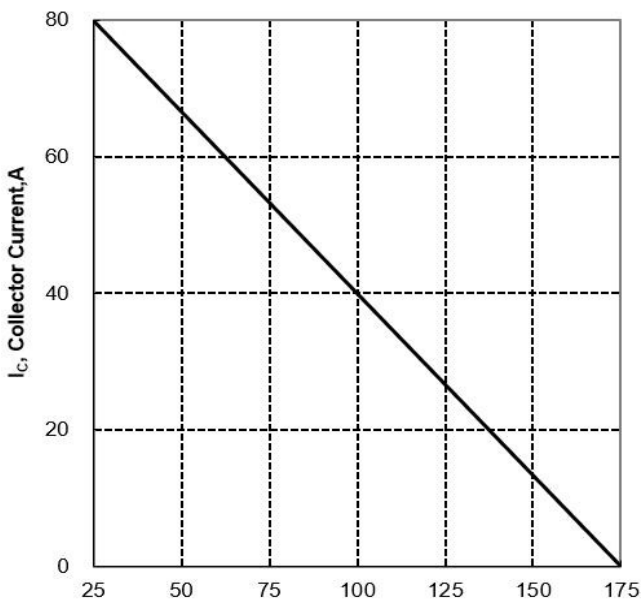

Figure 4. Typical Transfer Characteristics

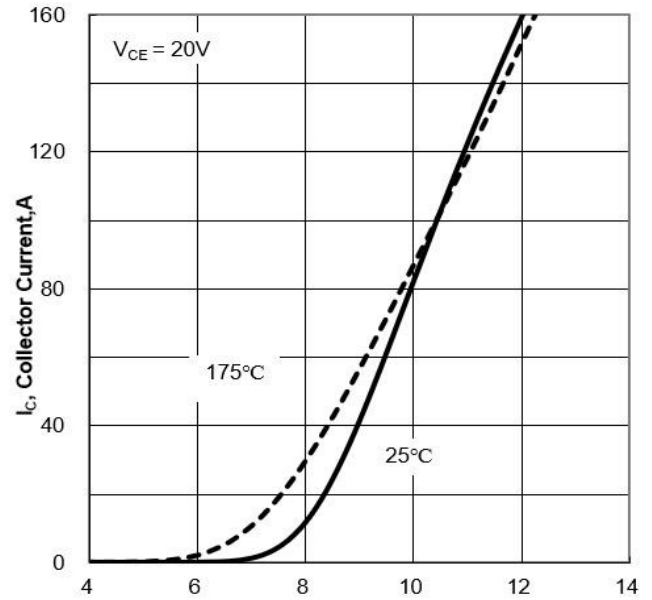

Figure 5. Typical Output Characteristics ($T_J=25^\circ\text{C}$)

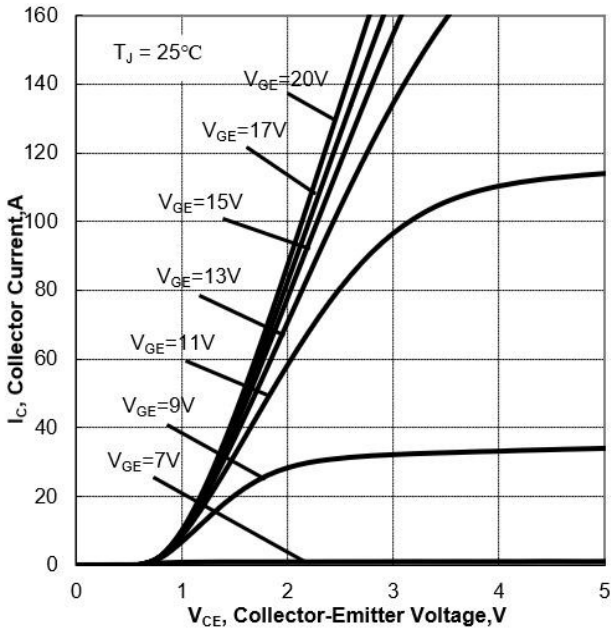

Figure 6. Typical Output Characteristics ($T_J=175^\circ\text{C}$)

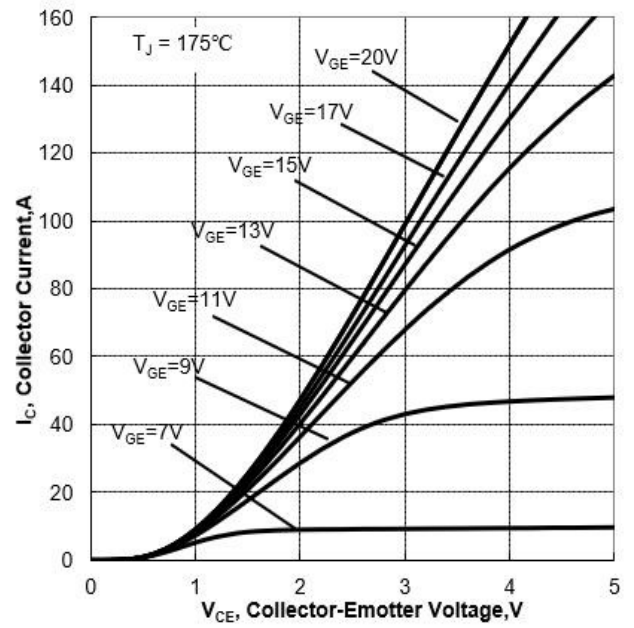

Figure 7. Typical Collector-Emitter Saturation Voltage vs Junction Temperature

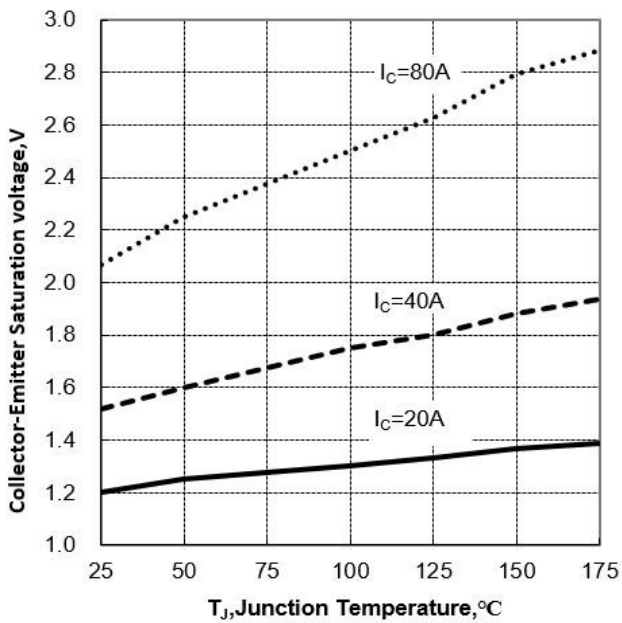

Figure 8. Typical Gate-Emitter Threshold Voltage vs Junction Temperature

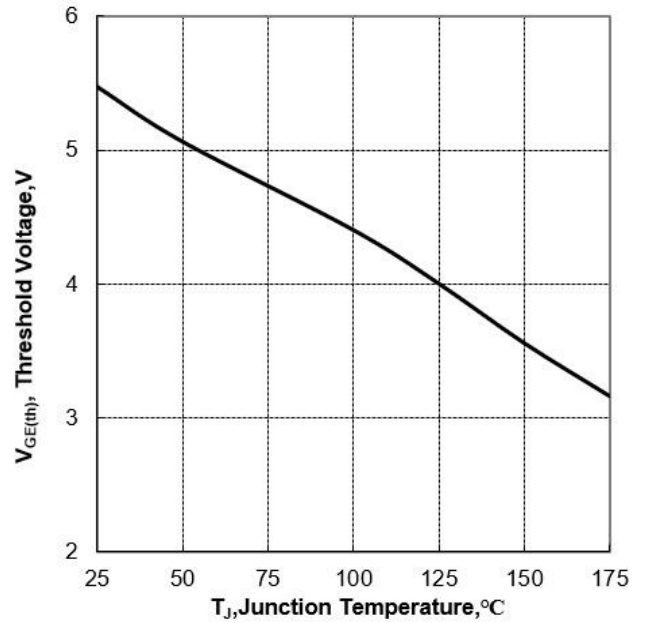

Figure 9. Typical Switching Times vs Gate Resistor
($T_J=25^\circ\text{C}$, $V_{CE}=400\text{V}$, $V_{GE}=15/0\text{V}$, $I_C=40\text{A}$)

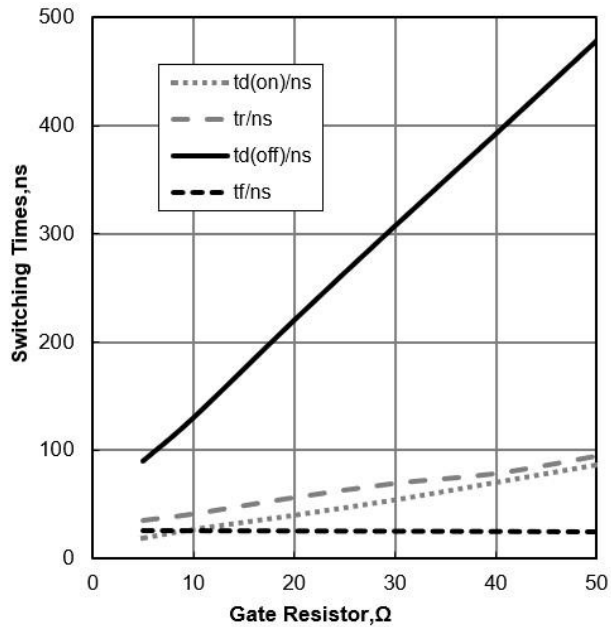

Figure 10. Typical Switching Energy vs Gate Resistor
($T_J=25^\circ\text{C}$, $V_{CE}=400\text{V}$, $V_{GE}=15/0\text{V}$, $I_C=40\text{A}$)

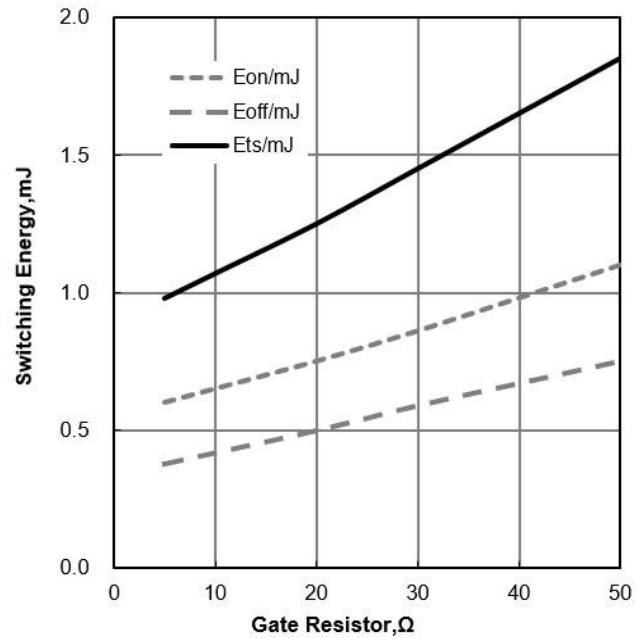

Figure 11. Typical Switching Times vs Junction Temperature
($V_{CE}=400\text{V}$, $V_{GE}=15/0\text{V}$, $I_C=40\text{A}$)

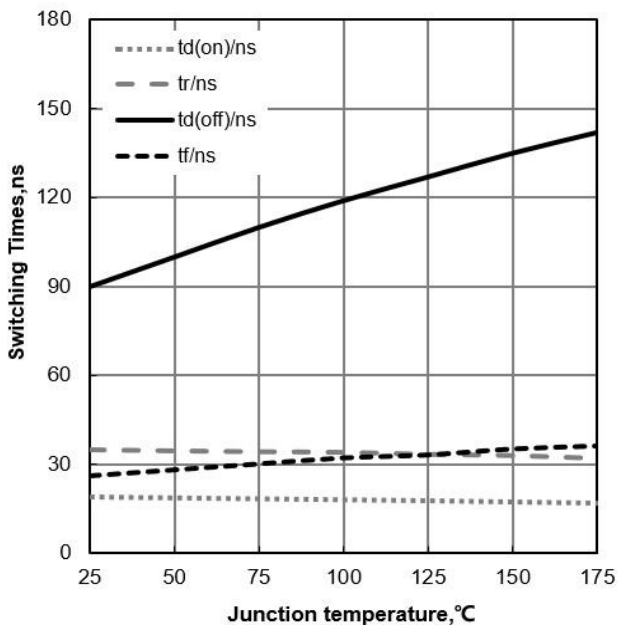

Figure 12. Typical Switching Energy vs Junction Temperature
($V_{CE}=400\text{V}$, $V_{GE}=15/0\text{V}$, $I_C=40\text{A}$)

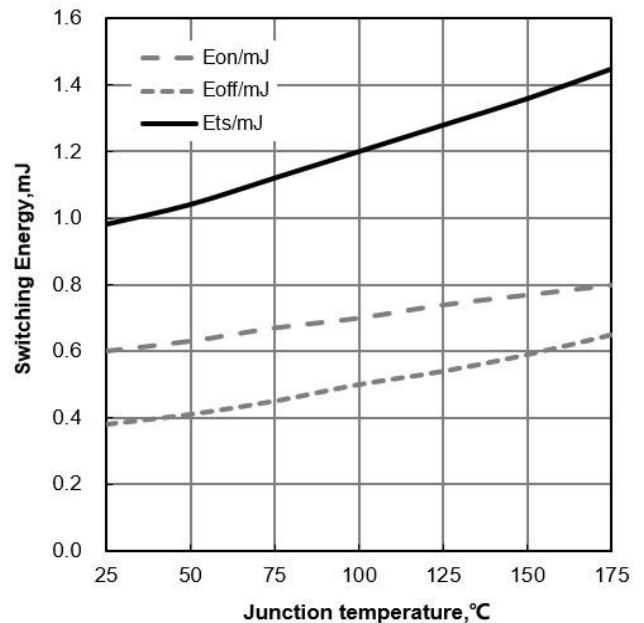

Figure 13. Typical Switching Times vs Collector Current
($T_J=25^\circ\text{C}$, $V_{CE}=400\text{V}$, $V_{GE}=15/0\text{V}$)

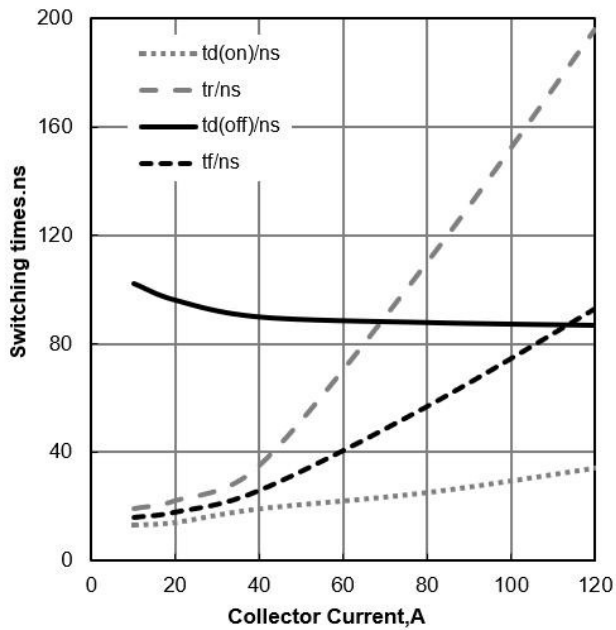

Figure 14. Typical Switching Energy vs Collector Current
($T_J=25^\circ\text{C}$, $V_{CE}=400\text{V}$, $V_{GE}=15/0\text{V}$)

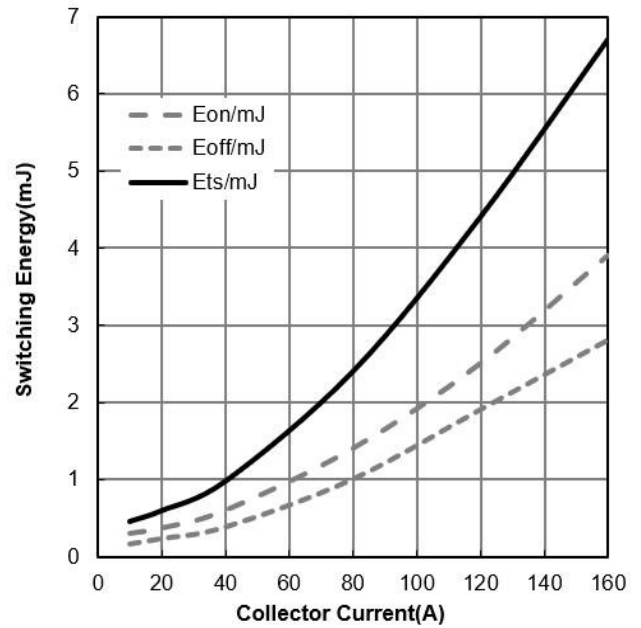

Figure 15. Typical Switching Times vs VCE
($T_J=25^\circ\text{C}$, $V_{GE}=15/0\text{V}$, $I_C=40\text{A}$)

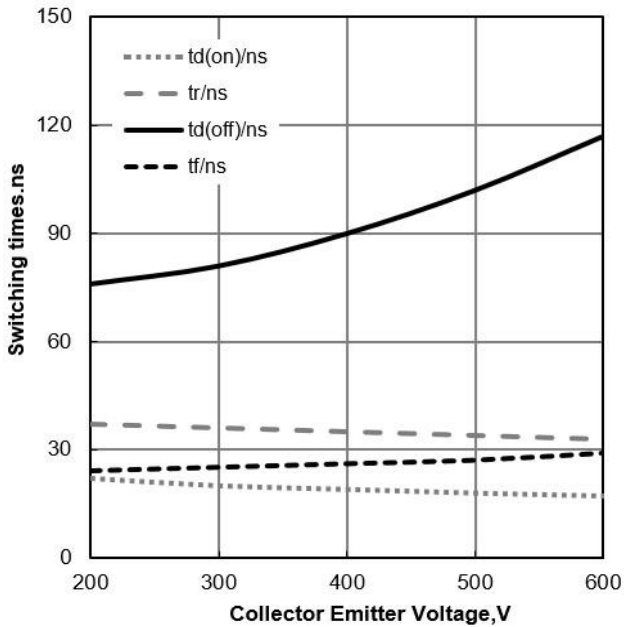

Figure 16. Typical Switching Energy vs VCE ($T_J=25^\circ\text{C}$, $V_{GE}=15/0\text{V}$, $I_C=40\text{A}$)

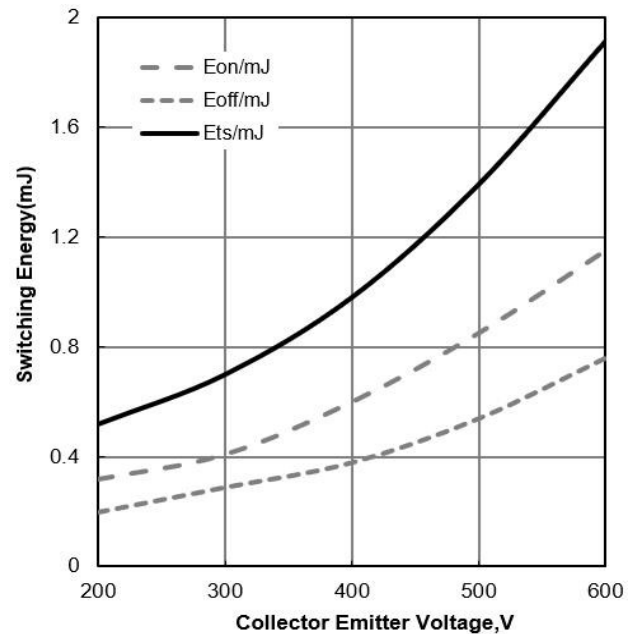

Figure 17. Typical Gate Charge

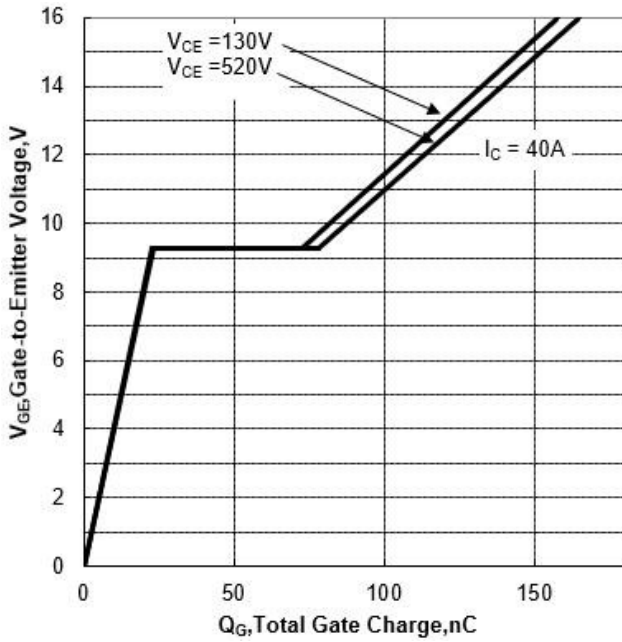

Figure 18. Typical Capacitance vs Collector-Emitter Voltage

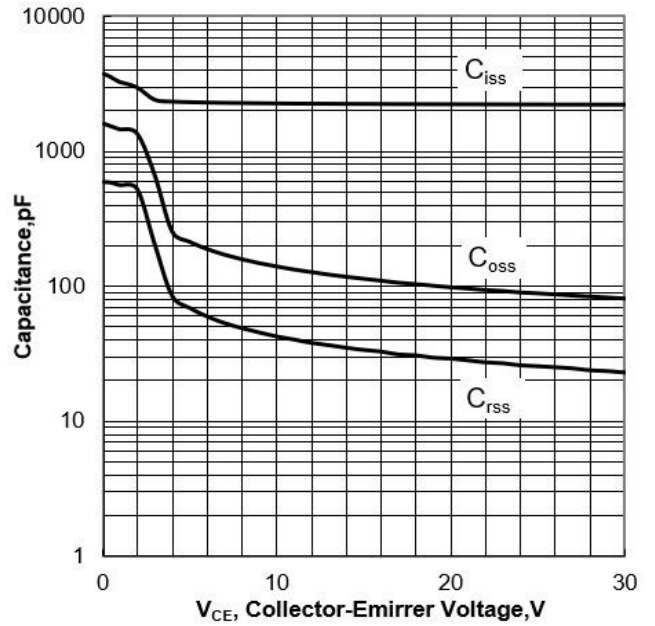

Figure 19. IGBT Transient Thermal Impedance vs Pulse Width(TO3PN/TO247)

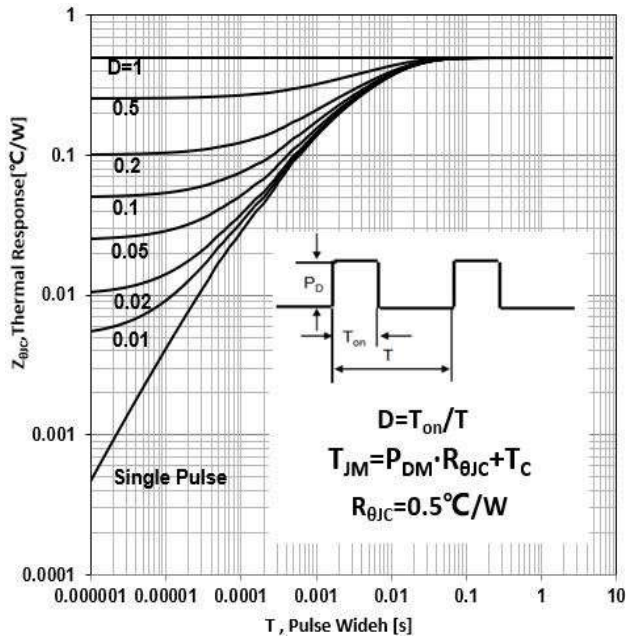

Figure 20. Diode Transient Thermal Impedance vs Pulse Width(TO3PN/TO247)

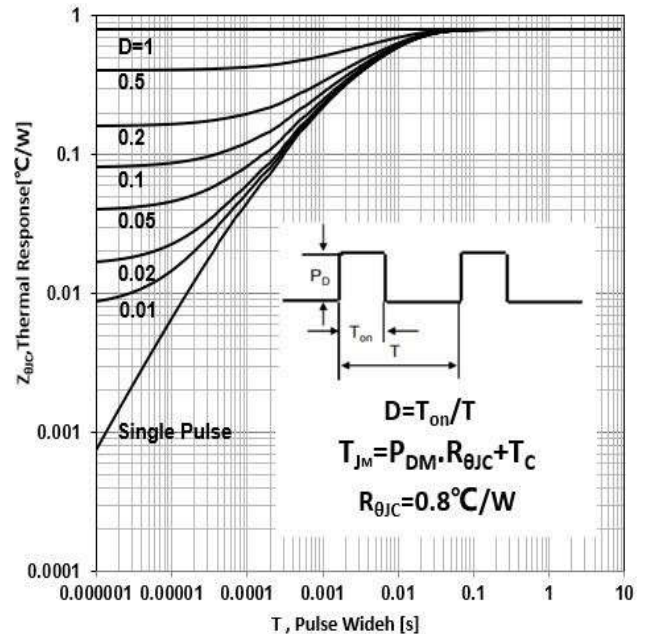

Figure 21. Typical Diode Forward Current vs Forward Voltage

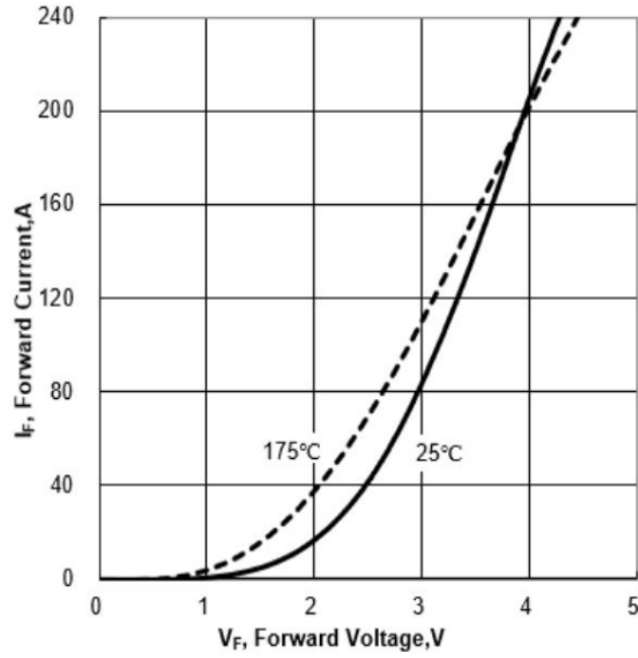
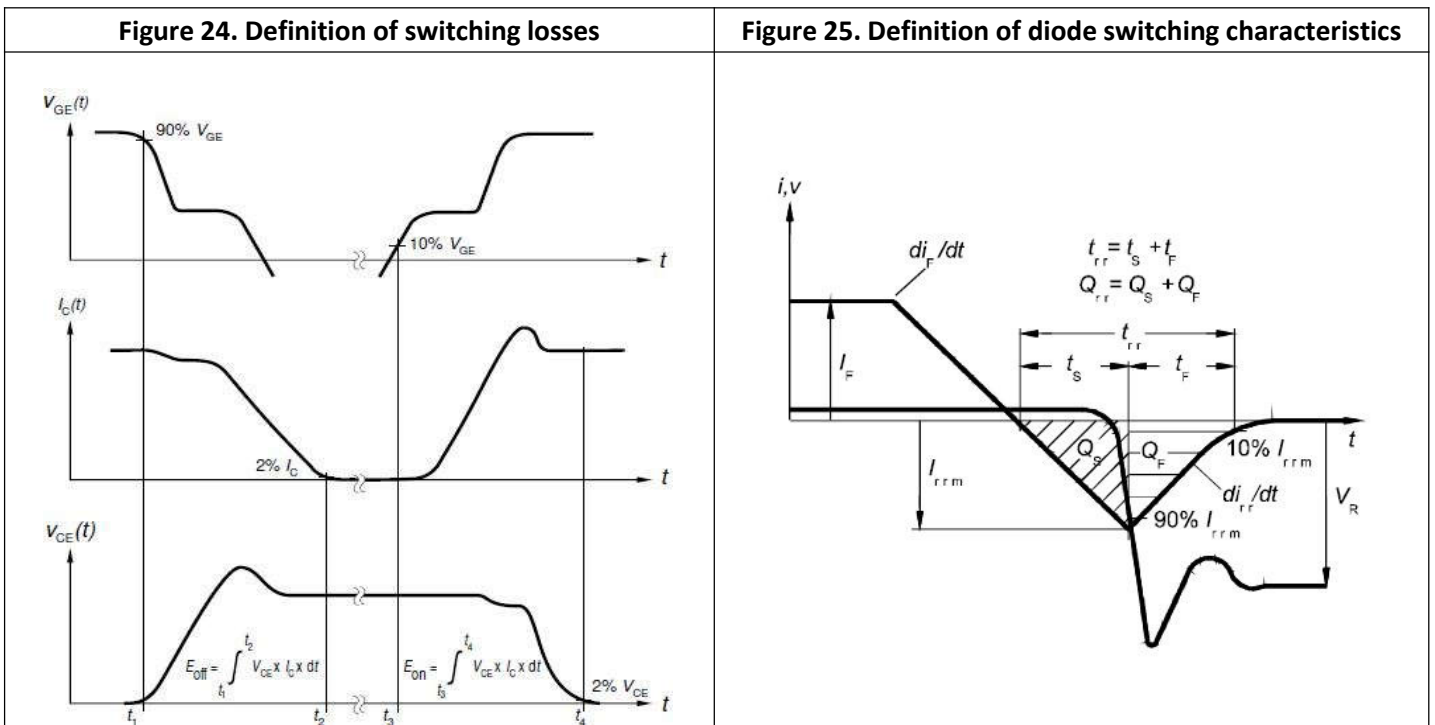
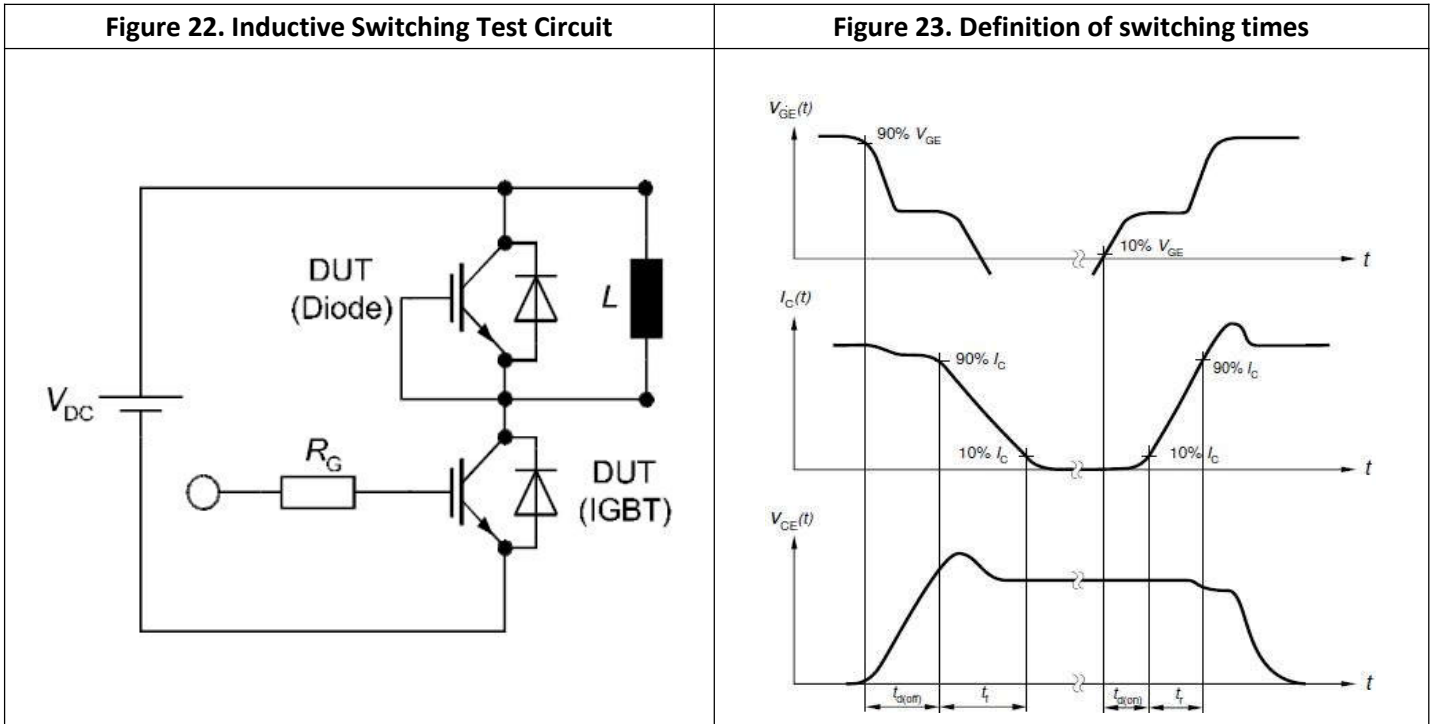
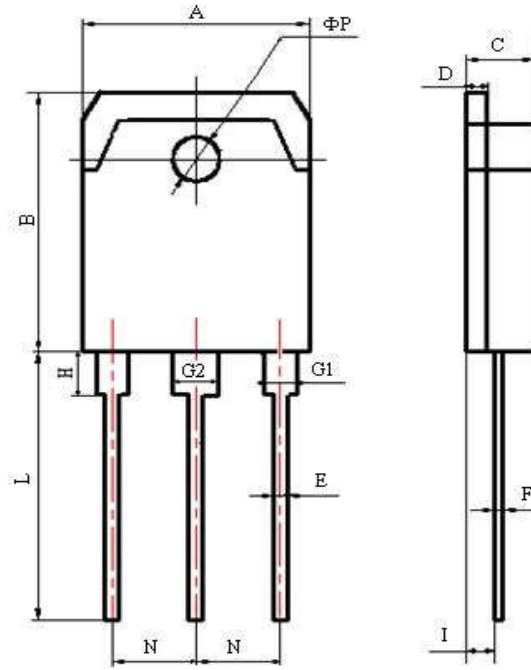

Figure 21. Typical Diode Forward Current vs Forward Voltage



Package Description



TO-3PN Package

Items	Values(mm)	
	MIN	MAX
A	15.00	16.00
B	19.20	20.60
C	4.60	5.00
D	1.40	1.60
E	0.90	1.10
F	0.50	0.70
G1	2.00	2.20
G2	3.00	3.20
H	3.00	3.70
I	1.20	1.70
	2.70	2.90
L	19.00	21.00
N	5.25	5.65
	3.10	3.30

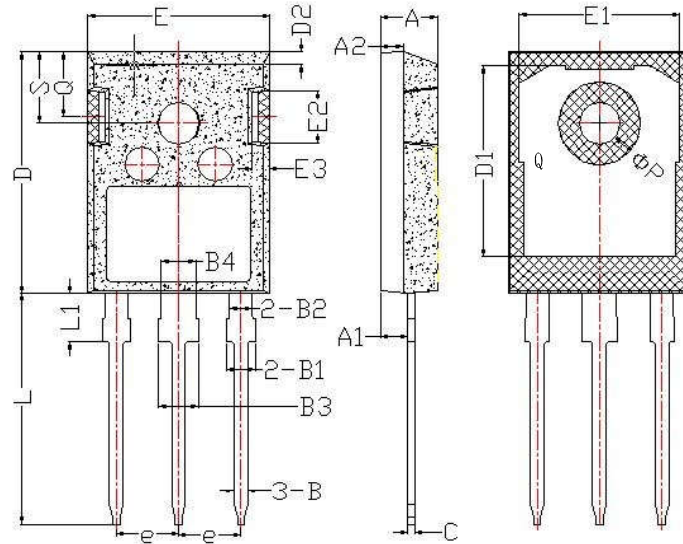

TO-247 Package

Items	Values(mm)	
	MIN	MAX
A	4.90	5.16
A1	2,27	2.53
A2	1.85	2.11
B	1.07	1.33
B1	1.90	2.41
B2	1.75	2.15
B3	2.87	3.38
B4	2.87	3.13
C	0.55	0.68
D	20.82	21.10
D1	16.25	17.65
D2	1.05	1.35
E	15.70	16.03
E1	13.10	14.15
E2	3.68	5.10
E3	1.68	2.60
e	5.44	
L	19.80	20.31
L1	4.17	4.47
ΦP	3.50	3.70
Q	5.49	6.00
S	6.04	6.30



NOTE:

1. Exceeding the maximum ratings of the device in performance may cause damage to the device, even the permanent failure, which may affect the dependability of the machine. Please do not exceed the absolute maximum ratings of the device when circuit designing.
2. When installing the heat sink, please pay attention to the torsional moment and the smoothness of the heat sink.
3. MOSFETs is the device which is sensitive to the static electricity, it is necessary to protect the device from being damaged by the static electricity when using it.
4. Shenzhen Minos reserves the right to make changes in this specification sheet and is subject to change without prior notice.

CONTACT:

深圳市迈诺斯科技有限公司（总部）

地址：深圳市福田区华富街道田面社区深南中路4026号田面城市大厦22B-22C

邮编：518025

电话：0755-83273777

X-ON Electronics

Largest Supplier of Electrical and Electronic Components

Click to view similar products for [Minos](#) manufacturer:

Other Similar products are found below :

[MDT35P10D](#) [IRF3205](#) [MD33N25](#) [MP18N20](#) [MPT035N08](#) [MP50N06](#) [MPF5N65](#) [MPG55N06](#) [MPF50N25](#) [MPG200N08](#) [MPG100N03](#)
[MP180N06](#) [L7806CV](#) [MPT028N10](#) [MBRF30100CT](#) [LA4440](#) [TIP42C](#) [C2073](#) [MPG80N06](#) [MPG100N06](#) [L7815CV](#) [L7805CV](#) [BT137-600E](#)
[TIP41C](#) [MPT65N08](#) [TTA1943](#) [MD23N50](#) [MPG180N10P](#) [MPG60NF06](#) [MPG08N68S](#) [MBR10100CT](#) [MBRF10100CT](#) [MBR20100CT](#)
[MBR30100CT](#) [MBRF20100CT](#) [MPG120N06](#) [MPF13N50](#) [MPG30N10](#) [MPF8N65](#) [MD200N08](#) [MLG40T65FUK](#) [MP9N20](#) [MPG150N10P](#)
[A940](#) [L7905CV](#) [MPF7N65](#) [MP150N08](#) [MPG60N10P](#) [MJL21194](#) [MPG30N06](#)