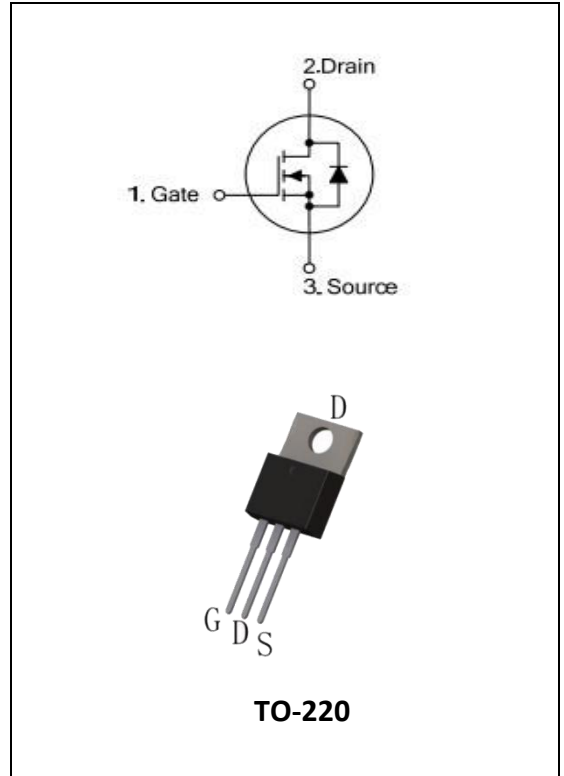


Silicon N-Channel Power MOSFET

Description

MP3205, the silicon N-channel Enhanced MOSFETS, is obtained by advanced MOSFET technology which reduce the conduction loss, improve switching performance and enhance the avalanche energy. The transistor is suitable device for Synchronous Rectification, inverter systems, high speed switching and general purpose applications.



KEY CHARACTERISTICS

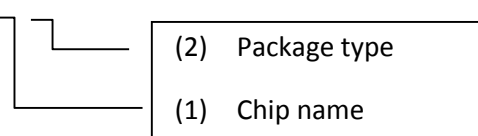
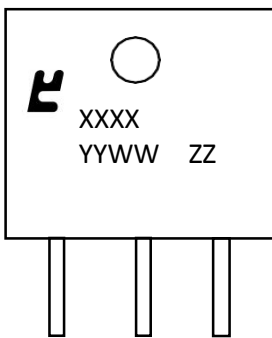
- ① $V_{DS}=55V, I_D=110A$ $R_{DS(ON)} < 9m\Omega @ V_{GS}=10V$
- ② Fast Switching
- ③ Low C_{rss}
- ④ 100% avalanche tested
- ⑤ Improved dv/dt capability
- ⑥ RoHS product

APPLICATIONS

- ① Power management for 12V inverter systems
- ② Synchronous Rectification

ORDERING INFORMATION

Ordering Codes	Package	Product Code	Packing
MP3205	TO-220	MP3205B	Tube

<p>MP3205</p>  <p>(1) Chip name</p> <p>(2) Package type</p> <p>(1) MP3205:55V 110A (2) Package type:TO-220</p>	 <p>XXXX: Product Code</p> <p>YYWW: Year&Week</p> <p>ZZ: Assembly Code</p>
---	--



ABSOLUTE RATINGS at TC = 25°C, unless otherwise specified

Symbol	Parameter	Rating	Units
V _{DSS}	Drain-to-Source Voltage	55	V
I _D	Continuous Drain Current	110	A
	Continuous Drain Current TC = 100 °C	80	A
I _{DM}	Pulsed Drain Current(Note1)	440	A
V _{GS}	Gate-to-Source Voltage	±20	V
E _{AS}	Single Pulse Avalanche Energy(Note2)	1500	mJ
I _{AR}	Avalanche Current	25	A
E _{AR}	Repetitive Avalanche Current	20	mJ
dv/dt	Peak Diode Recovery dv/dt(Note3)	5.0	V/ns
P _D	Power Dissipation TO-220	210	W
	Derating Factor above 25°C	1.25	W/°C
T _J , T _{stg}	Operating Junction and Storage Temperature Range	175, -55 to 175	°C
T _L	Maximum Temperature for Soldering	300	°C

Thermal characteristics

Thermal characteristics (No FullPAK) TO-220

Symbol	Parameter	RATINGS	Units
R _{θJC}	Junction-to-Case	0.75	°C/W
R _{θJA}	Junction-to-Ambient	62.5	°C/W

Electrical Characteristics at TC = 25°C, unless otherwise specified

OFF Characteristics						
Symbol	Parameter	Test Conditions	Values			Units
			Min.	Typ.	Max.	
V _{DSS}	Drain to Source Breakdown Voltage	V _{GS} =0V, I _D =250μA	55	--	--	V
ΔBV _{DSS} /ΔT _J	Bvdss Temperature Coefficient	I _D =250uA, Reference 25°C	--	0.055	--	V/°C
I _{DSS}	Drain to Source Leakage Current	V _D S =55V, V _G S= 0V, T _j = 25°C	--	--	1	μA
		V _D S =44V, V _G S= 0V, T _j = 125°C	--	--	10	μA
I _{GSS(F)}	Gate to Source Forward Leakage	V _G S =+20V	--	--	100	nA



IGSS(R)	Gate to Source Reverse Leakage	V _{GS} = -20V	--	--	100	nA
---------	--------------------------------	------------------------	----	----	-----	----

ON Characteristics						
Symbol	Parameter	Test Conditions	Values			Units
			Min.	Typ.	Max.	
R _{DS(ON)}	Drain-to-Source On- Resistance	V _{GS} =10V, I _D =40A	--	7.2	9	mΩ
V _{GS(TH)}	Gate Threshold Voltage	V _{DS} = V _{GS} , I _D = 250μA	2	--	4	V
g _{fs}	Forward Transconductance	V _{DS} =20V, I _D =40A(Note4)	--	65	--	S

Dynamic Characteristics						
Symbol	Parameter	Test Conditions	Values			Units
			Min.	Typ.	Max.	
R _g	Gate resistance	f = 1.0MHz	--	1.7	--	Ω
C _{iss}	Input Capacitance	V _{GS} = 0V V _{DS} = 25V f = 1.0MHz	--	3247	--	PF
C _{oss}	Output Capacitance		--	781	--	
C _{rss}	Reverse Transfer Capacitance		--	211	--	

Switching Characteristics						
Symbol	Parameter	Test Conditions	Values			Units
			Min.	Typ.	Max.	
t _{d(ON)}	Turn-on Delay Time	I _D =62A V _{DD} =28V V _{GS} = 10V R _G =4.5Ω	--	14	--	ns
t _r	Rise Time		--	101	--	
t _{d(OFF)}	Turn-Off Delay Time		--	50	--	
t _f	Fall Time		--	65	--	
Q _g	Total Gate Charge	I _D =62A V _{DD} =44V V _{GS} = 10V	--	146	--	nC
Q _{gs}	Gate to Source Charge		--	10	--	
Q _{gd}	Gate to Drain ("Miller")Charge		--	17.5	--	

Source-Drain Diode Characteristics						
Symbol	Parameter	Test Conditions	Values			Units
			Min.	Typ.	Max.	
I _S	Continuous Source Current (Body Diode)	TC=25 °C	--	--	110	A
I _{SM}	Maximum Pulsed Current (Body Diode)		--	--	440	A
V _{SD}	Diode Forward Voltage	I _S =62A, V _{GS} =0V	--	0.9	1.3	V



迈诺斯科技

MP3205

Trr	Reverse Recovery Time	IS=62A, Tj = 25°C dIF/dt=100A/us, VGS=0V	--	69	--	ns
Qrr	Reverse Recovery Charge		--	143	--	nC

Note1:Pulse width limited by maximum junction temperature

Note2: L=1mH, VD_s=44V, Start T_J=25°C

Note3: ISD≤110A, di/dt ≤300A/us, VDD≤BVDS, Start T_J=25°C

Note4:Pulse width tp≤300μs, δ≤2%

Characteristics Curves

Figure 1 Safe Operating Area

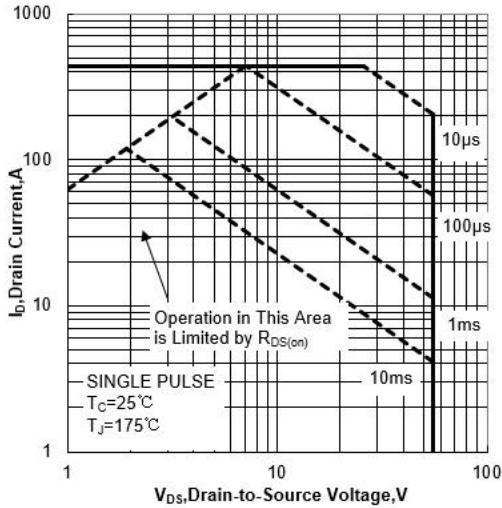


Figure 2 Max Thermal Impedance

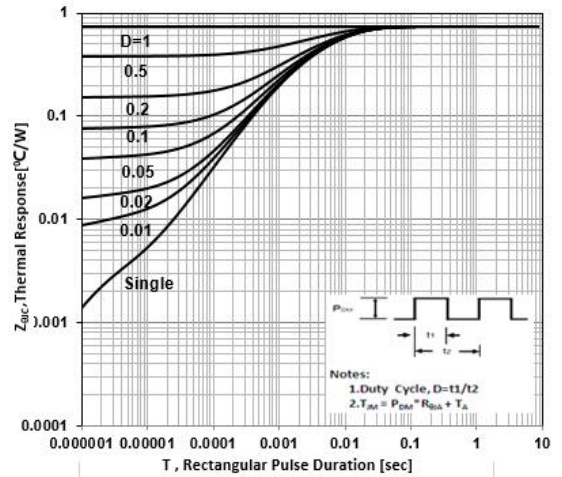


Figure 3 Typical Output Characteristics

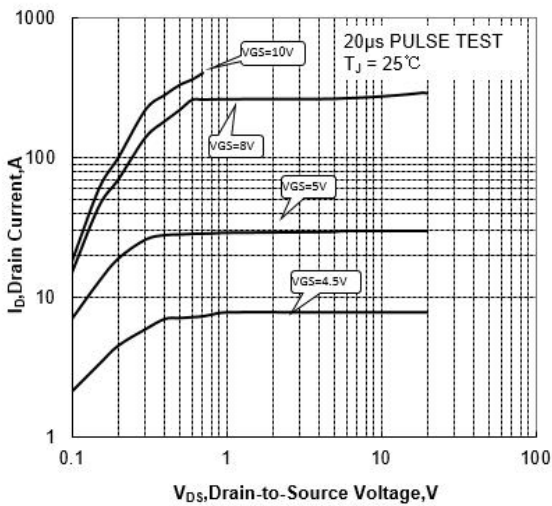


Figure 4 Typical Output Characteristics

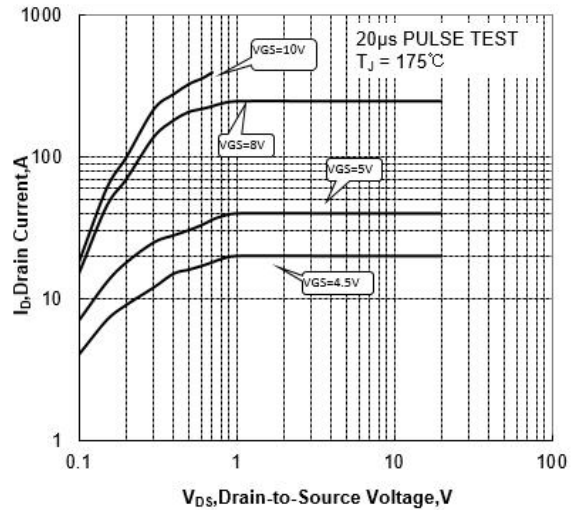


Figure 5 Typical Transfer Characteristics

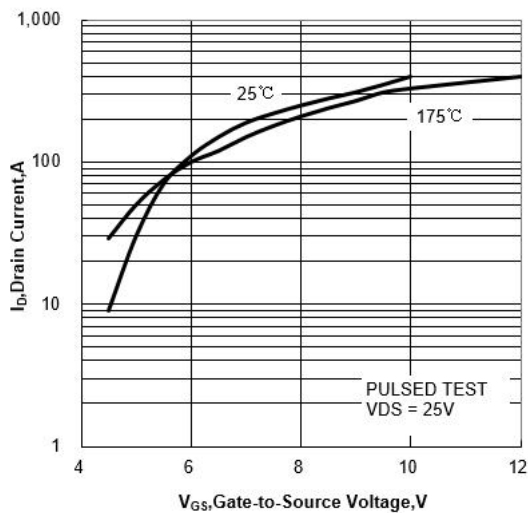


Figure 6 Typical Drain to Source on Resistance vs Junction Temperature

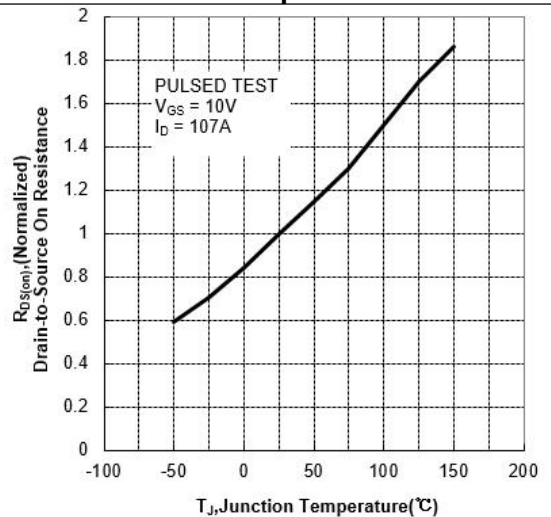


Figure 7 Maximum Drain Current vs Case Temperature

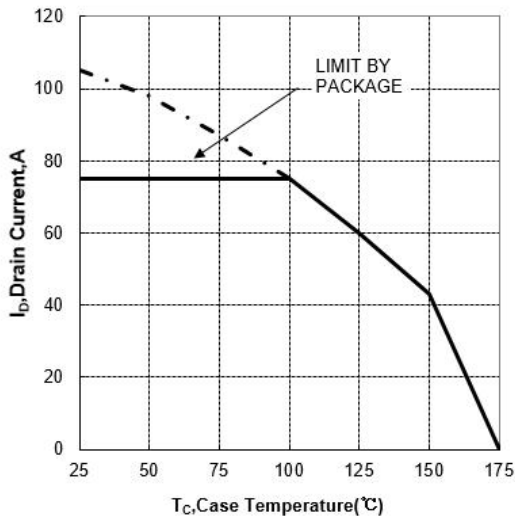


Figure 8 Typical Source-Drain Diode Forward Voltage

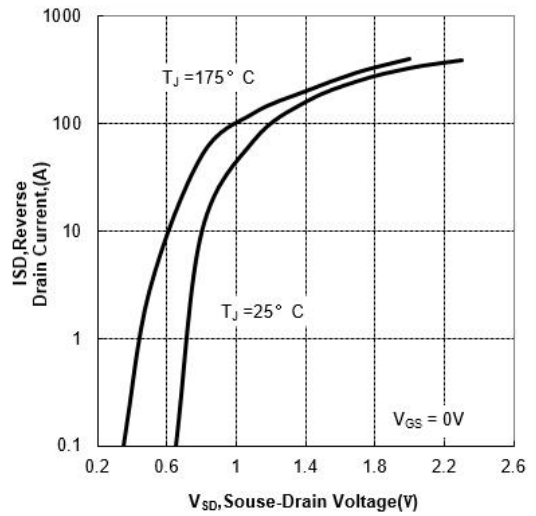


Figure 9 Typical Capacitance vs Drain-to-Source Voltage

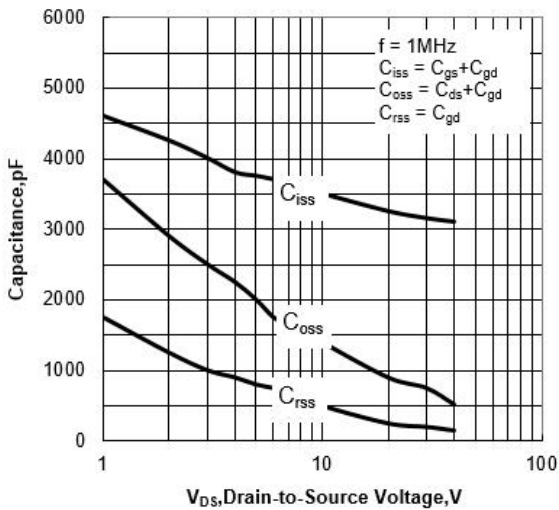
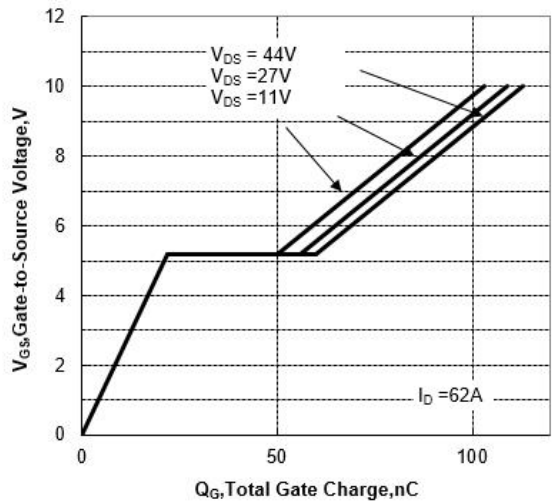


Figure 10 Typical Gate Charge vs Gate-to-Source Voltage



Test Circuit and Waveform

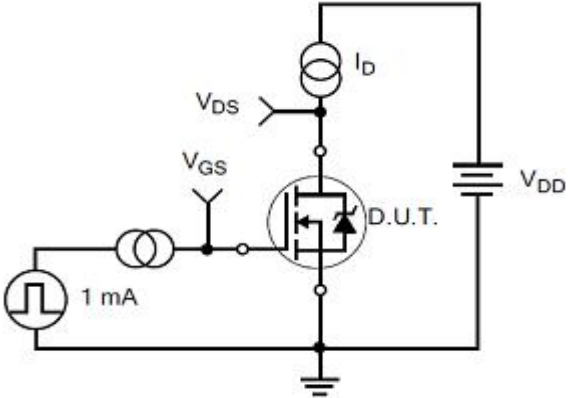
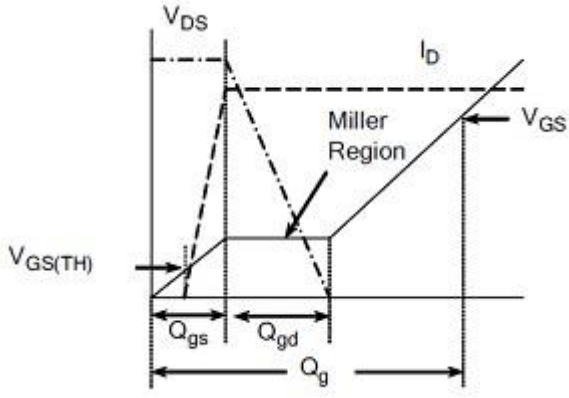
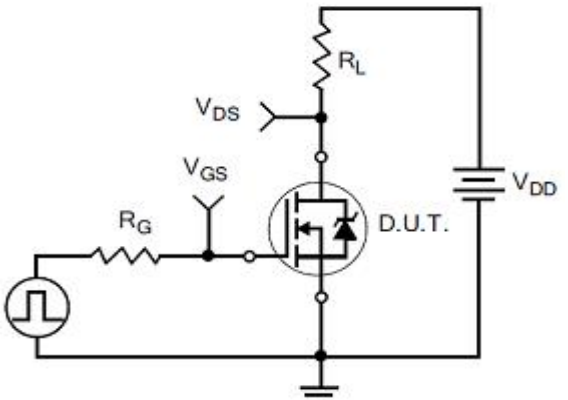
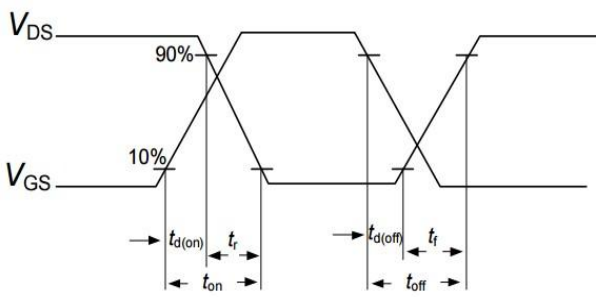
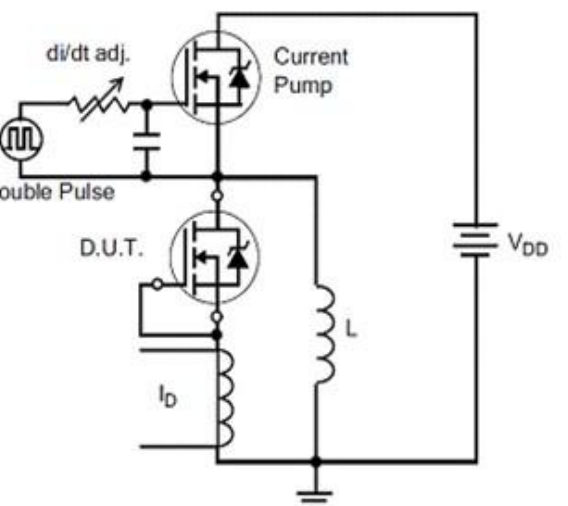
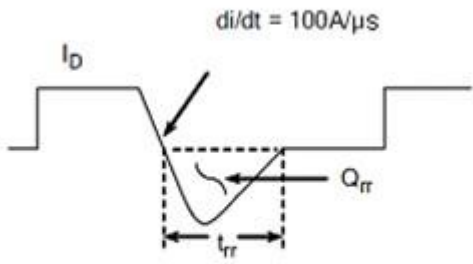
<p>Figure 12 Gate Charge Test Circuit</p> 	<p>Figure 13 Gate Charge Waveforms</p> 
<p>Figure 14 Resistive Switching Test Circuit</p> 	<p>Figure 15 Resistive Switching Waveforms</p> 
<p>Figure 16 Diode Reverse Recovery Test Circuit</p> 	<p>Figure 17 Diode Reverse Recovery Waveform</p> 

Figure 18 Unclamped Inductive Switching Test

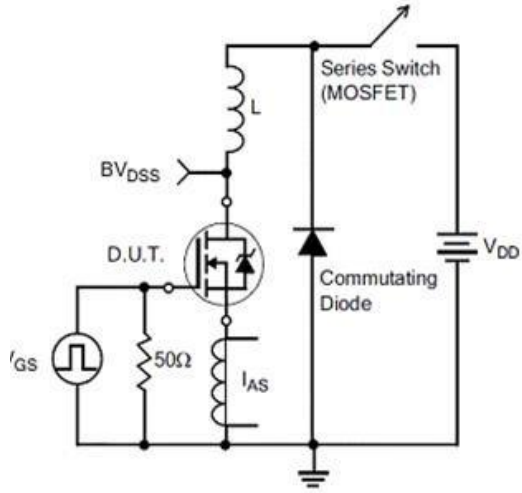
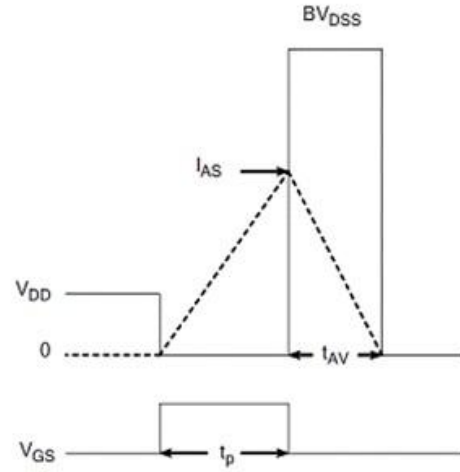
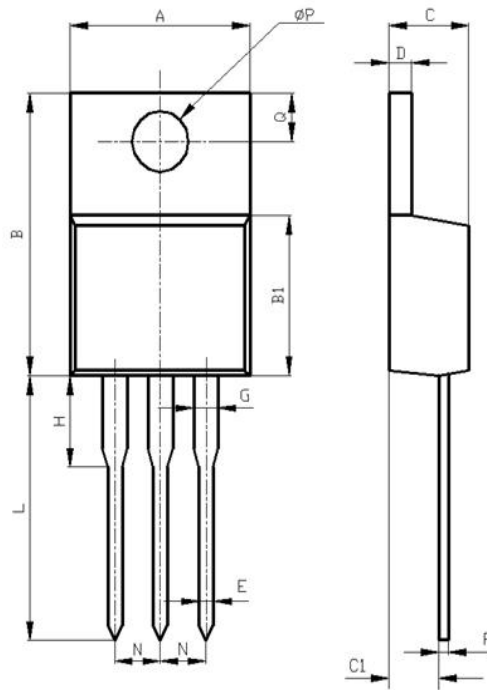


Figure 19 Unclamped Inductive Switching



Package Description



Items	Values(mm)	
	MIN	MAX
A	9.60	10.6
B	15.0	16.0
B1	8.90	9.50
C	4.30	4.80
C1	2.30	3.10
D	1.20	1.40
E	0.70	0.90
F	0.30	0.60
G	1.17	1.37
H	2.70	3.80
L	12.6	14.8
N	2.34	2.74
Q	2.40	3.00
ϕP	3.50	3.90

TO-220



NOTE:

1. Exceeding the maximum ratings of the device in performance may cause damage to the device, even the permanent failure, which may affect the dependability of the machine. Please do not exceed the absolute maximum ratings of the device when circuit designing.
2. When installing the heat sink, please pay attention to the torsional moment and the smoothness of the heat sink.
3. MOSFETs is the device which is sensitive to the static electricity, it is necessary to protect the device from being damaged by the static electricity when using it.
4. Shenzhen Minos reserves the right to make changes in this specification sheet and is subject to change without prior notice.

CONTACT:

深圳市迈诺斯科技有限公司（总部）

地址：深圳市福田区华富街道田面社区深南中路4026号田面城市大厦22B-22C

邮编：518025

电话：0755-83273777

X-ON Electronics

Largest Supplier of Electrical and Electronic Components

Click to view similar products for [MOSFET](#) category:

Click to view products by [Minos](#) manufacturer:

Other Similar products are found below :

[IRFD120](#) [IRFY240C](#) [JANTX2N5237](#) [2SK2267\(Q\)](#) [BUK455-60A/B](#) [MIC4420CM-TR](#) [VN1206L](#) [NDP4060](#) [SI4482DY](#)
[IPS70R2K0CEAKMA1](#) [SQD23N06-31L-GE3](#) [TK16J60W,S1VQ\(O](#) [2SK2614\(TE16L1,Q\)](#) [DMN1017UCP3-7](#) [EFC2J004NUZTDG](#)
[DMN1053UCP4-7](#) [SQJ469EP-T1-GE3](#) [NTE2384](#) [DMC2700UDMQ-7](#) [DMN2080UCB4-7](#) [DMN61D9UWQ-13](#) [US6M2GTR](#)
[DMN31D5UDJ-7](#) [DMP22D4UFO-7B](#) [DMN1006UCA6-7](#) [DMN16M9UCA6-7](#) [STF5N65M6](#) [IRF40H233XTMA1](#) [STU5N65M6](#)
[DMN6022SSD-13](#) [DMN13M9UCA6-7](#) [DMTH10H4M6SPS-13](#) [DMN2990UFB-7B](#) [IPB80P04P405ATMA2](#) [2N7002W-G](#) [MCAC30N06Y-](#)
[TP](#) [MCQ7328-TP](#) [NTMC083NP10M5L](#) [NVMFS2D3P04M8LT1G](#) [BXP7N65D](#) [BXP4N65F](#) [AOL1454G](#) [WMJ80N60C4](#) [BXP2N20L](#)
[BXP2N65D](#) [BXT1150N10J](#) [BXT1700P06M](#) [TSM60NB380CP](#) [ROG](#) [RQ7L055BGTCR](#) [DMNH15H110SK3-13](#)