

100V N-Channel Power MOSFET

DESCRIPTION

The MPG30N10 uses advanced trench technology to provide excellent $R_{DS(ON)}$, low gate charge. It can be used in a wide variety of applications.

KEY CHARACTERISTICS

- ① $V_{DS} = 100V, I_D = 30A$
 $R_{DS(ON)} < 30m\Omega @ V_{GS} = 10V$
- ② High density cell design for lower R_{dson}
- ③ Fully characterized avalanche voltage and current
- ④ Good stability and uniformity with high EAS
- ⑤ Excellent package for good heat dissipation

Application

- ① Power switching application
- ② Hard switched and High frequency circuits
- ③ Uninterruptible power supply

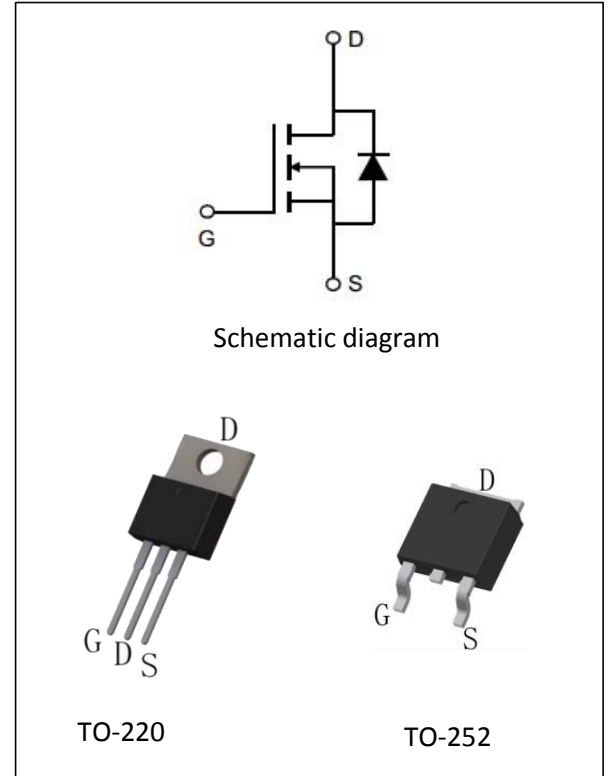

Package Marking And Ordering Information

Ordering Codes	Package	Product Code	Packing
MDT30N10-D	TO-252	MDT30N10D	Reel
MPG30N10-P	TO-220	MPG30N10P	Tube

Absolute Maximum Ratings (TA=25°C unless otherwise noted)

Parameter	Symbol	Limit	Unit
Drain-Source Voltage	V_{DS}	100	V
Gate-Source Voltage	V_{GS}	± 20	V
Drain Current-Continuous	I_D	30	A
Drain Current-Pulsed (Note 1)	I_{DM}	100	A
Maximum Power Dissipation (Tc=25°C)	P_D	70	W
Single pulse avalanche energy (Note 2)	E_{AS}	96	mJ
Operating Junction and Storage Temperature Range	T_J, T_{STG}	-55 To 175	°C

Thermal Characteristic

Thermal Resistance, Junction-to-Case	$R_{\theta JC}$	3.5	°C/W
--------------------------------------	-----------------	-----	------

Electrical Characteristics (TA=25°C unless otherwise noted)

Parameter	Symbol	Condition	Min	Typ	Max	Unit
Off Characteristics						
Drain-Source Breakdown Voltage	BV_{DSS}	$V_{GS}=0V, I_D=250\mu A$	100	-	-	V
Zero Gate Voltage Drain Current	I_{DSS}	$V_{DS}=100V, V_{GS}=0V$	-	-	1	μA
Gate-Body Leakage Current	I_{GSS}	$V_{GS}=\pm 20V, V_{DS}=0V$	-	-	± 100	nA
On Characteristics						
Gate Threshold Voltage	$V_{GS(th)}$	$V_{DS}=V_{GS}, I_D=250\mu A$	1.2	2.3	3	V
Drain-Source On-State Resistance ^(Note 3)	$R_{DS(ON)}$	$V_{GS}=10V, I_D=12A$	-	25	30	m Ω
Forward Transconductance	g_{FS}	$V_{DS}=5V, I_D=15A$	-	11	-	S
Dynamic Characteristics						
Input Capacitance	C_{ISS}	$V_{DS}=25V,$ $V_{GS}=0V,$ $f=1.0MHz$	-	2550	-	pF
Output Capacitance	C_{OSS}		-	225	-	pF
Reverse Transfer Capacitance	C_{RSS}		-	205	-	pF
Switching Characteristics ^(Note 4)						
Turn-on Delay Time	$t_{d(on)}$	$V_{DD}=50V,$ $I_D=20A,$ $V_{GS}=10V,$ $R_{GEN}=10\Omega$	-	29	-	nS
Turn-on Rise Time	t_r		-	13	-	nS
Turn-Off Delay Time	$t_{d(off)}$		-	58.2	-	nS
Turn-Off Fall Time	t_f		-	13.4	-	nS
Total Gate Charge	Q_g	$V_{DS}=80V, I_D=20A, V_{GS}=10V$	-	55	-	nC
Gate-Source Charge	Q_{gs}		-	15	-	nC
Gate-Drain Charge	Q_{gd}		-	20	-	nC
Drain-Source Diode Characteristics						
Diode Forward Voltage	V_{SD}	$V_{GS}=0V, I_S=20A$	-	-	1.2	V
Reverse Recovery Time	T_{rr}	$T_j=25^\circ C, I_F=10A,$ $di/dt=100A/\mu S$ ^(note3)	-	58	-	nS
Reverse Recovery Charge	Q_{rr}		-	110	-	nC

Notes:

- 1.Repetitive Rating: Pulse width limited by maximum junction temperature.
- 2.EAS condition :T j=25°C ,VDD=50V,VGS=10V,L=0.5mH,Rg=25 Ω
- 3.Pulse Test: Pulse Width $\leq 300\mu s$, Duty Cycle $\leq 2\%$.
- 4.Guaranteed by design, not subject to production.

Characteristics Curves

Figure 1 Output Characteristics

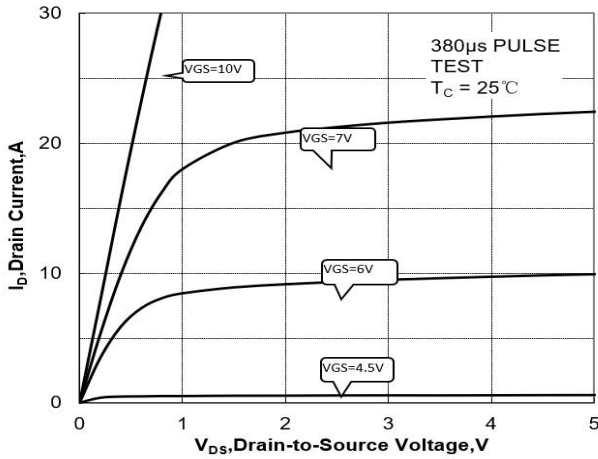

Figure 2 Transfer Characteristics

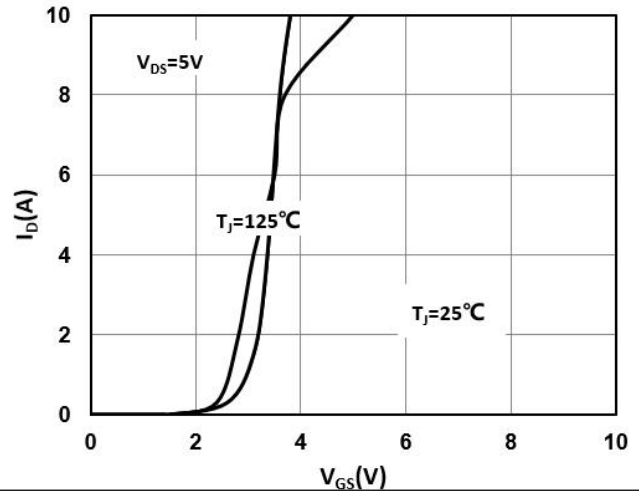

Figure 3 On-Resistance vs. ID and VGS

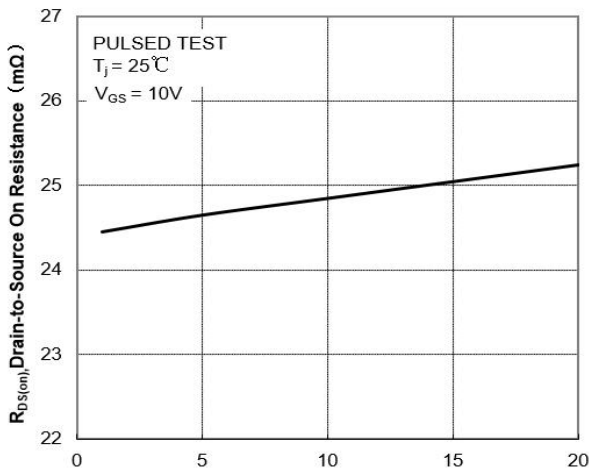

Figure 4 On-Resistance vs. Junction Temperature

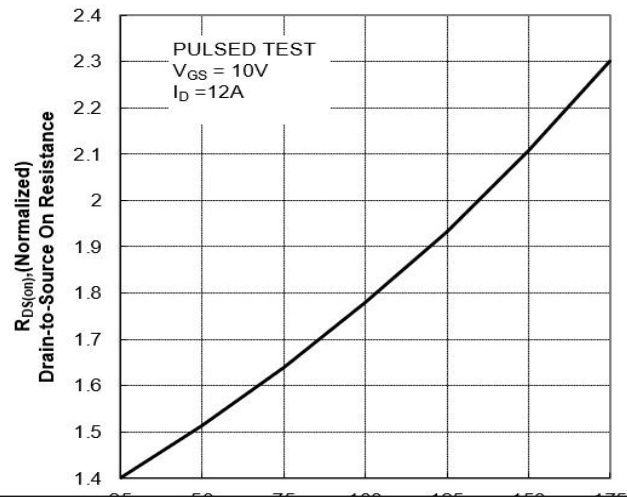

Figure 5 On-Resistance vs. VGS

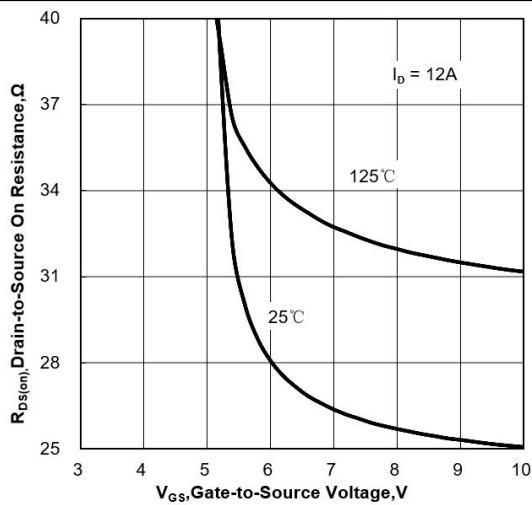

Figure 6 Body Diode Forward Voltage

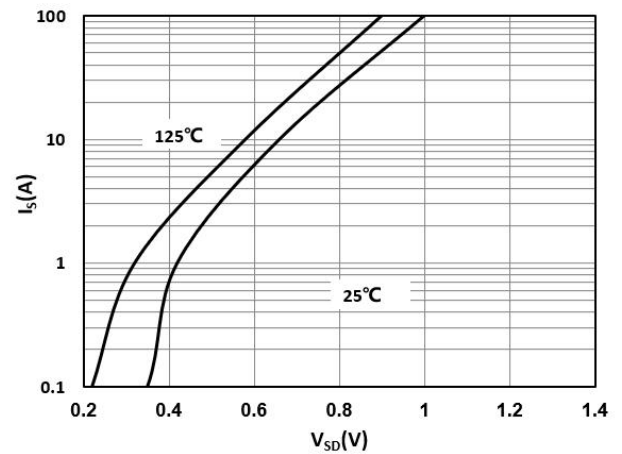

Figure 7 Gate-Charge Characteristics

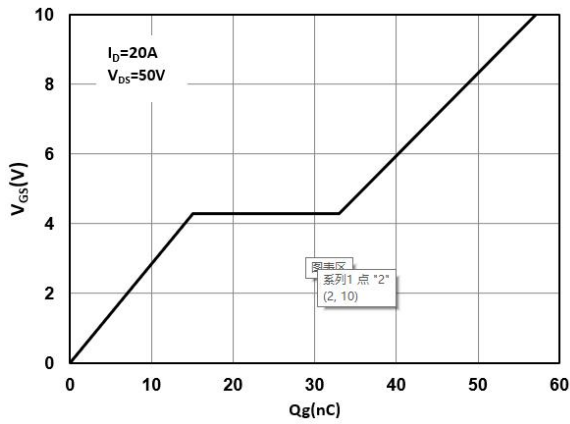

Figure 8 Capacitance Characteristics

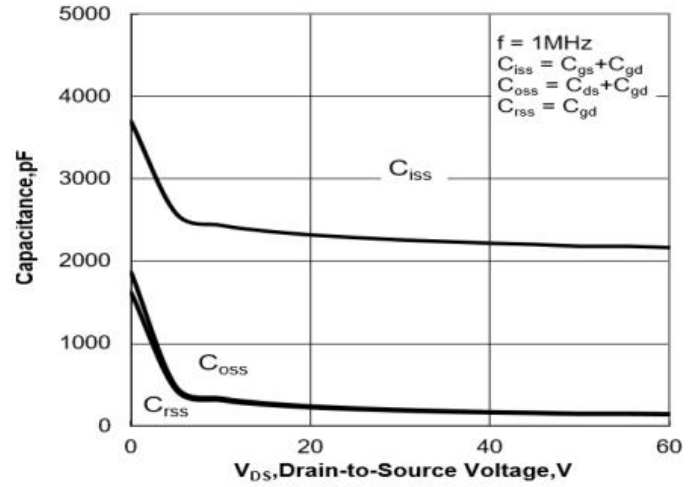

Figure 9 Maximum Forward Biased Safe Operation Area

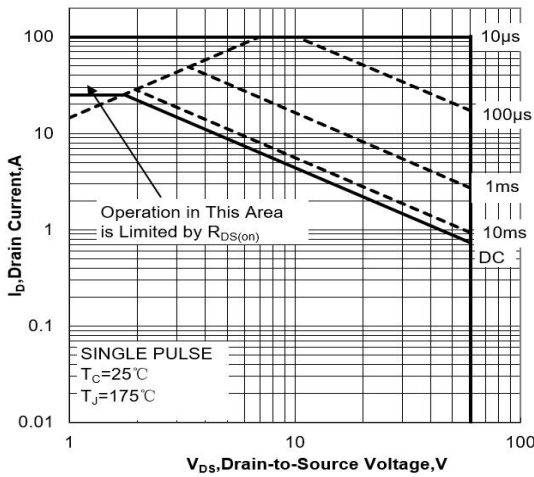

Figure 10 Single Pulse Power Rating Junction-to-Ambient

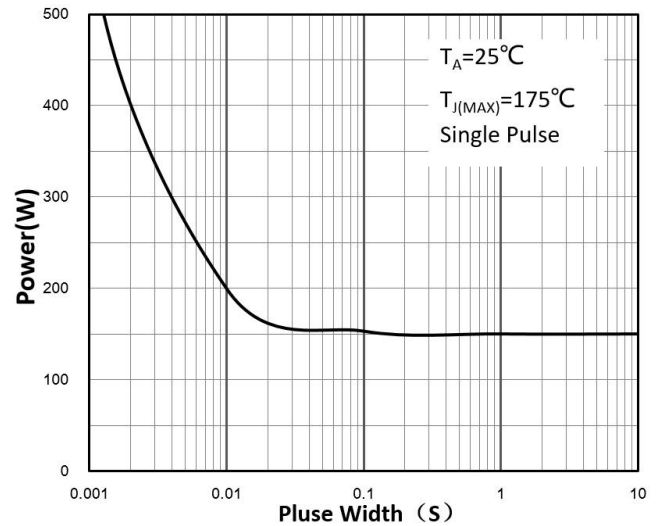
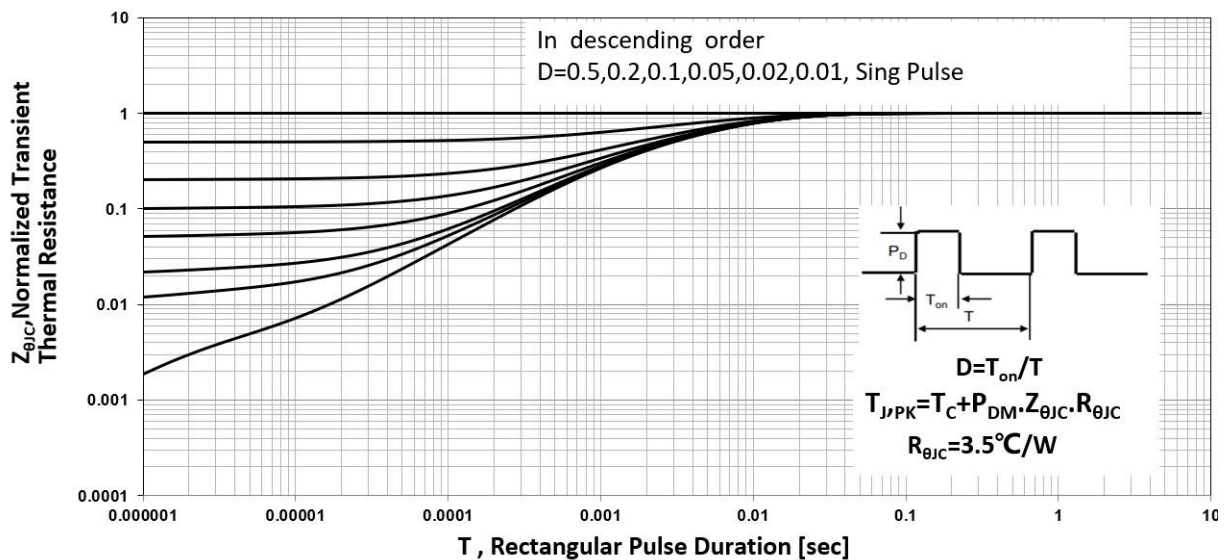
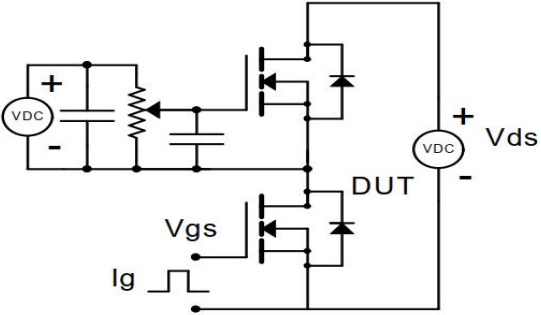
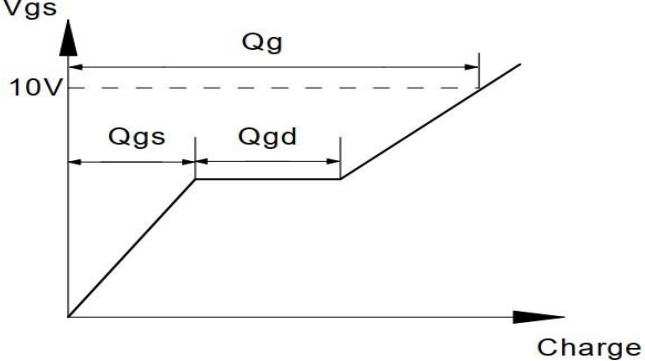
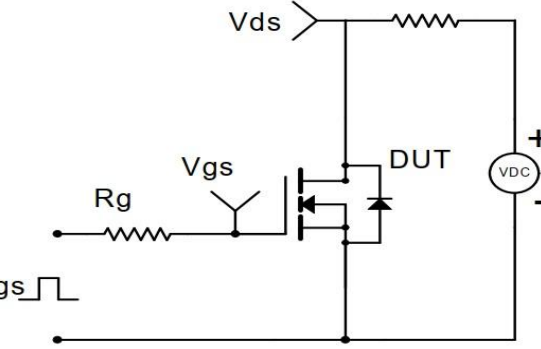
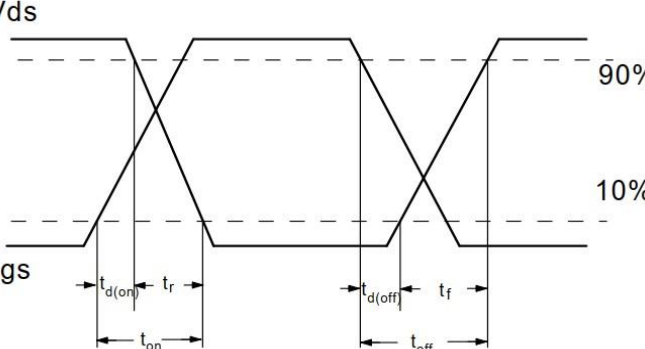
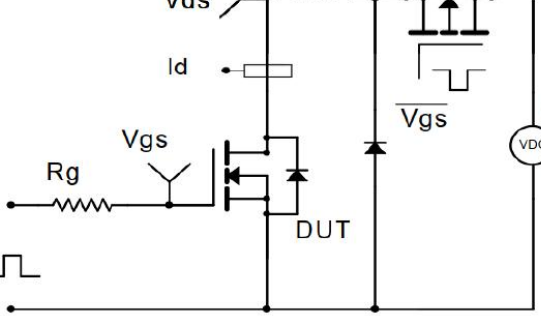
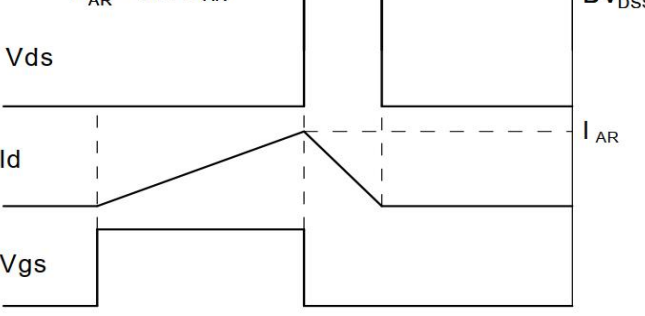
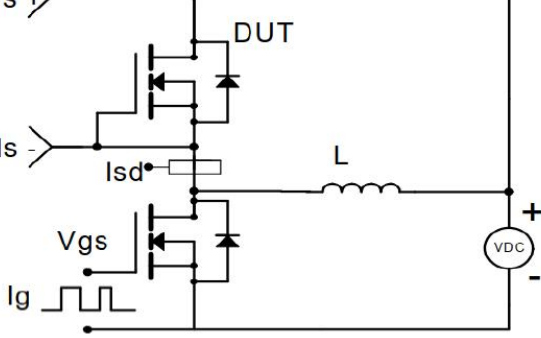
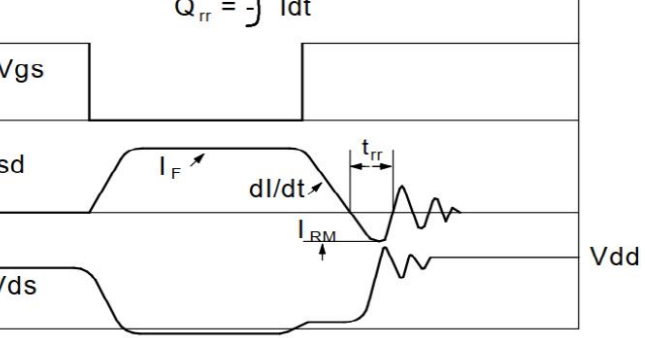
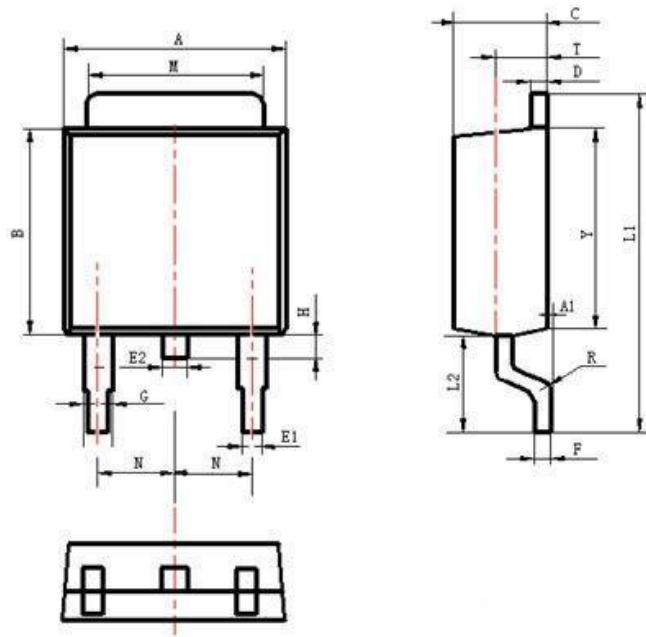

Figure 11 Normalized Maximum Transient Thermal Impedance



Gate Charge Test Circuit	Gate Charge Test Waveform
 <p>The diagram shows a MOSFET circuit for gate charge testing. A VDC source is connected to the drain through a resistor. The gate is driven by a pulse source Ig through a resistor. The DUT (Device Under Test) is connected between the drain and source. The gate-source voltage Vgs is also indicated.</p>	 <p>The graph plots Vgs against Charge. It shows a linear ramp up to a plateau at 10V, followed by a linear ramp down. The total area under the curve is labeled Qg. The area under the ramp up is Qgs, and the area under the ramp down is Qgd.</p>
Resistive Switching Test Circuit	Resistive Switching Test Waveforms
 <p>The diagram shows a MOSFET switching a load resistor RL. The drain is connected to RL and a VDC source. The gate is driven by a pulse source Vgs through a resistor Rg. The DUT is connected between the drain and source.</p>	 <p>The graph shows Vds and Vgs waveforms. Vds is high during the off-state and drops to 10% during the on-state. Vgs is a pulse. Key timing parameters are labeled: td(on), tr, ton, td(off), tff, toff.</p>
Unclamped Inductive Switching (UIS) Test Circuit	Unclamped Inductive Switching (UIS) Test Waveforms
 <p>The diagram shows a MOSFET switching an inductive load L. The drain is connected to L and a VDC source. The gate is driven by a pulse source Vgs through a resistor Rg. The DUT is connected between the drain and source.</p>	 <p>The graph shows Vds, Id, and Vgs waveforms. Vds rises to BV_{DSS} during the switching transient. Id is the load current. The energy stored in the inductor is given by $E_{AR} = 1/2 L I_{AR}^2$.</p>
Diode Recovery Test Circuit	Diode Recovery Test Waveforms
 <p>The diagram shows a MOSFET switching an inductive load L. The drain is connected to L and a VDC source. The gate is driven by a pulse source Ig through a resistor. The DUT is connected between the drain and source.</p>	 <p>The graph shows Vgs, Isd, and Vds waveforms. Isd is the source current. The diode recovery time trr is indicated. The reverse recovery current I_{RM} is shown. The equation $Q_{rr} = \int Idt$ is provided.</p>

Package Description



Items	Values (mm)	
	MIN	MAX
A	6.30	6.90
A1	0	0.13
B	5.70	6.30
C	2.10	2.50
D	0.30	0.60
E1	0.60	0.90
E2	0.70	1.00
F	0.30	0.60
G	0.70	1.20
L1	9.60	10.50
L2	2.70	3.10
H	0.60	1.00
M	5.10	5.50
N	2.09	2.49
R	0.3	
T	1.40	1.60
Y	5.10	6.30

TO-252 Package

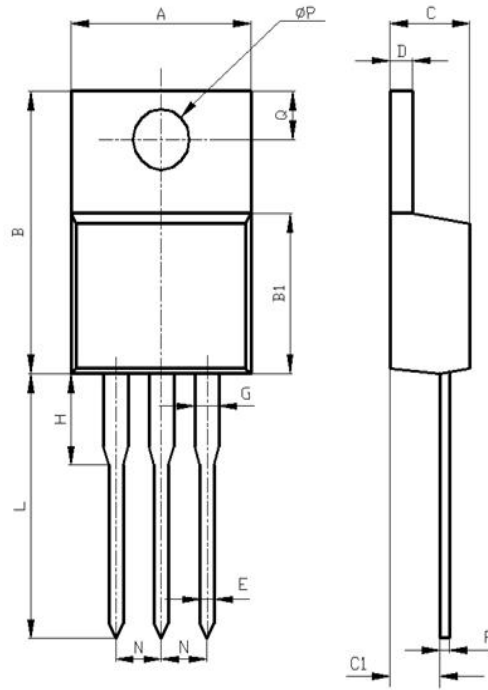

Items	Values(mm)	
	MIN	MAX
A	9.60	10.6
B	15.0	16.0
B1	8.90	9.50
C	4.30	4.80
C1	2.30	3.10
D	1.20	1.40
E	0.70	0.90
F	0.30	0.60
G	1.17	1.37
H	2.70	3.80
L	12.6	14.8
N	2.34	2.74
Q	2.40	3.00
φ P	3.50	3.90

TO-220 Package



NOTE:

1. Exceeding the maximum ratings of the device in performance may cause damage to the device, even the permanent failure, which may affect the dependability of the machine. Please do not exceed the absolute maximum ratings of the device when circuit designing.
2. When installing the heat sink, please pay attention to the torsional moment and the smoothness of the heat sink.
3. MOSFETs is the device which is sensitive to the static electricity, it is necessary to protect the device from being damaged by the static electricity when using it.
4. Shenzhen Minos reserves the right to make changes in this specification sheet and is subject to change without prior notice.

CONTACT:

深圳市迈诺斯科技有限公司（总部）

地址：深圳市福田区华富街道田面社区深南中路4026号田面城市大厦22B-22C

邮编：518025

电话：0755-83273777

X-ON Electronics

Largest Supplier of Electrical and Electronic Components

Click to view similar products for [MOSFET](#) category:

Click to view products by [Minos](#) manufacturer:

Other Similar products are found below :

[IRFD120](#) [IRFY240C](#) [JANTX2N5237](#) [2SK2267\(Q\)](#) [BUK455-60A/B](#) [MIC4420CM-TR](#) [VN1206L](#) [NDP4060](#) [SI4482DY](#)
[IPS70R2K0CEAKMA1](#) [SQD23N06-31L-GE3](#) [TK16J60W,S1VQ\(O](#) [2SK2614\(TE16L1,Q\)](#) [DMN1017UCP3-7](#) [EFC2J004NUZTDG](#)
[DMN1053UCP4-7](#) [SQJ469EP-T1-GE3](#) [NTE2384](#) [DMC2700UDMQ-7](#) [DMN2080UCB4-7](#) [DMN61D9UWQ-13](#) [US6M2GTR](#)
[DMN31D5UDJ-7](#) [DMP22D4UFO-7B](#) [DMN1006UCA6-7](#) [DMN16M9UCA6-7](#) [STF5N65M6](#) [IRF40H233XTMA1](#) [STU5N65M6](#)
[DMN6022SSD-13](#) [DMN13M9UCA6-7](#) [DMTH10H4M6SPS-13](#) [DMN2990UFB-7B](#) [IPB80P04P405ATMA2](#) [2N7002W-G](#) [MCAC30N06Y-](#)
[TP](#) [MCQ7328-TP](#) [NTMC083NP10M5L](#) [NVMFS2D3P04M8LT1G](#) [BXP7N65D](#) [BXP4N65F](#) [AOL1454G](#) [WMJ80N60C4](#) [BXP2N20L](#)
[BXP2N65D](#) [BXT1150N10J](#) [BXT1700P06M](#) [TSM60NB380CP](#) [ROG](#) [RQ7L055BGTCR](#) [DMNH15H110SK3-13](#)