

## 100V N-Channel Power MOSFET

### Description

MPT028N10, the N-channel Enhanced Power MOSFETs, is obtained by advanced double trench technology which reduce the conduction loss, improve switching performance and enhance the avalanche energy. This is suitable device for BMS and high current switching applications.

### General Features

- ①  $V_{DS}=100V$ ,  $R_{ds(on)} < 3m\Omega$  @  $V_{GS}=10V$ ,  $I_D=180A$  (Typ:  $2.7m\Omega$ )
- ② Fast Switching
- ③ Low On-Resistance
- ④ Low Gate Charge
- ⑤ Low Reverse transfer capacitances
- ⑥ High avalanche ruggedness
- ⑦ RoHS product

### Application

- ① BMS
- ② High current switching applications

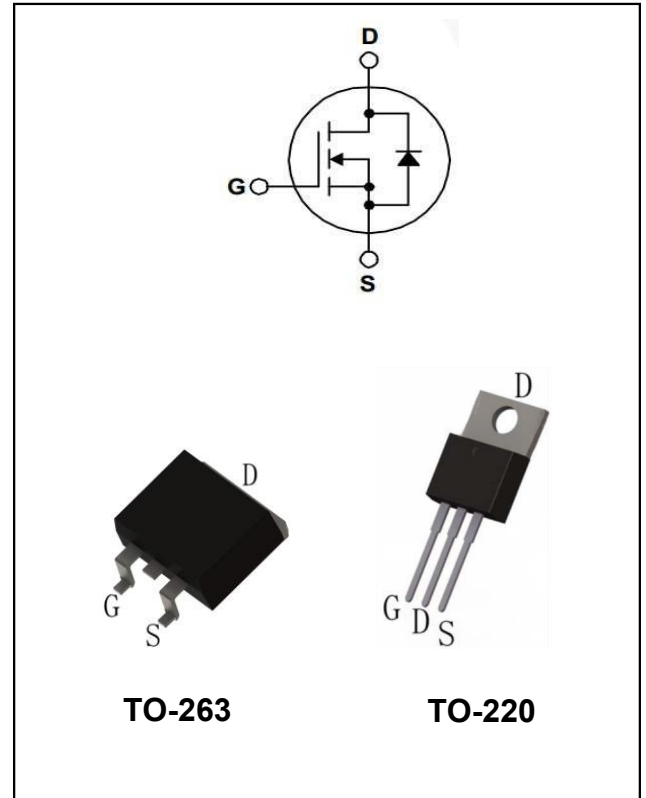

### Package Marking And Ordering Information:

| Ordering Codes | Package | Product Code | Packing   |
|----------------|---------|--------------|-----------|
| MPT028N10-P    | TO-220  | 028N10       | Tube      |
| MPT028N10-S    | TO-263  | 028N10       | Tape Reel |

### ABSOLUTE RATINGS at $T_C=25^\circ C$ , unless otherwise specified

| Symbol           | Parameter  | Rating   | Units |
|------------------|--|----------|-------|
| $V_{DSS}$        | Drain-Source Voltage   | 100      | V     |
| $I_D$            | Continuous Drain Current, Silicon Limited                      | 200      | A     |
|                  | Continuous Drain Current, Package Limited                      | 180      | A     |
|                  | Continuous Drain Current @ $T_C=100^\circ C$ , Silicon Limited | 126.6    | A     |
| $I_{DM}^{Note1}$ | Pulsed Drain Current   | 720      | A     |
| $V_{GS}$         | Gate-Source Voltage  | $\pm 20$ | V     |



|                  |  |                 |      |
|------------------|--|-----------------|------|
| $E_{AS}^{Note2}$ | Avalanche Energy                                 | 784             | mJ   |
| $P_D$            | Power Dissipation                                | 250             | W    |
|                  | Derating Factor above 25°C                       | 2               | W/°C |
| $T_J, T_{stg}$   | Operating Junction and Storage Temperature Range | 150, -55 to 150 | °C   |
| $T_L$            | Maximum Temperature for Soldering                | 260             | °C   |

Note1: Repetitive Rating: Pulse width limited by maximum junction temperature Note2: L=0.5mH, I<sub>as</sub>=35A, Start T<sub>J</sub>=25°C

### Thermal characteristics

| Symbol          | Parameter                            | Max  | Units |
|-----------------|--------------------------------------|------|-------|
| $R_{\theta JC}$ | thermal resistance, Junction-Case    | 0.5  | °C/W  |
| $R_{\theta JA}$ | thermal resistance, Junction-Ambient | 62.5 | °C/W  |

### Electrical Characteristics at T<sub>c</sub>=25°C, unless otherwise specified

| OFF Characteristics |                                |   |        |     |      |       |
|---------------------|--------------------------------|---|--------|-----|------|-------|
| Symbol              | Parameter                      | Test Conditions                                   | Values |     |      | Units |
|                     |                                |   | Min    | Typ | Max  |       |
| $V_{DSS}$           | Drain-Source Breakdown Voltage | $V_{GS}=0V, I_D=250\mu A$                         | 100    | 110 | --   | V     |
| $I_{DSS}$           | Drain-Source Leakage Current   | $V_{DS}=100V, V_{GS}=0V$                          | --     | --  | 1    | μA    |
|                     |                                | $V_{DS}=80V, V_{GS}=0V$<br>@T <sub>c</sub> =125°C | --     | --  | 100  | μA    |
| $I_{GSS(F)}$        | Gate-Source Forward Leakage    | $V_{GS}=+20V$                                     | --     | --  | 100  | nA    |
| $I_{GSS(R)}$        | Gate-Source Reverse Leakage    | $V_{GS}=-20V$                                     | --     | --  | -100 | nA    |

| ON Characteristics                               |                            |                               |        |     |     |       |
|--|----------------------------|-------------------------------|--------|-----|-----|-------|
| Symbol   | Parameter                  | Test Conditions               | Values |     |     | Units |
|  |                            |                               | Min    | Typ | Max |       |
| $R_{DS(on)}$                                     | Drain-Source On-Resistance | $V_{GS}=10V, I_D=50A$         | --     | 2.7 | 3   | mΩ    |
| $V_{GS(th)}$                                     | Gate Threshold Voltage     | $V_{DS}=V_{GS}, I_D=250\mu A$ | 2.0    | 3.0 | 4.0 | V     |
| Pulse width $t_p \leq 300\mu s, \delta \leq 2\%$ |                            |                               |        |     |     |       |

| Dynamic Characteristics |                              |                                |        |      |     |       |
|-------------------------|------------------------------|--------------------------------|--------|------|-----|-------|
| Symbol                  | Parameter                    | Test Conditions                | Values |      |     | Units |
|                         |                              |                                | Min    | Typ  | Max |       |
| $C_{iss}$               | Input Capacitance            | $V_{DS}=50V, V_{GS}=0, f=1MHz$ | --     | 9200 | --  | pF    |
| $C_{oss}$               | Output Capacitance           |                                | --     | 1130 | --  |       |
| $C_{rss}$               | Reverse Transfer Capacitance |                                | --     | 110  | --  |       |



|          |                    |   |    |      |    |    |
|----------|--------------------|---|----|------|----|----|
| $Q_g$    | Total Gate Charge  | $V_{DD}=50V,$<br>$I_D=92.5A,$<br>$V_{GS}=10V$ | -- | 131  | -- | nC |
| $Q_{gs}$ | Gate-Source charge |   | -- | 50   | -- |    |
| $Q_{gd}$ | Gate-Drain charge  |   | -- | 24.5 | -- |    |

**Switching Characteristics**

| Symbol       | Parameter           | Test Conditions  | Values |     |     | Units |
|--------------|---------------------|--|--------|-----|-----|-------|
|              |                     |  | Min    | Typ | Max |       |
| $t_{d(on)}$  | Turn-On Delay Time  | $V_{DD}=50V,$<br>$V_{GS}=10V,$<br>$R_G=1.6\Omega,$<br>Resistive Load | --     | 32  | --  | ns    |
| $t_r$        | Rise Time           |  | --     | 40  | --  |       |
| $t_{d(off)}$ | Turn-Off Delay Time |  | --     | 80  | --  |       |
| $t_f$        | Fall Time           |  | --     | 35  | --  |       |

**Source-Drain Diode Characteristics**

| Symbol   | Parameter                 | Test Conditions                 | Values |     |     | Units   |
|----------|---------------------------|---------------------------------|--------|-----|-----|---------|
|          |                           |                                 | Min    | Typ | Max |         |
| $I_S$    | Continuous Source Current |                                 | --     | --  | 180 | A       |
| $I_{SM}$ | Maximum Pulsed Current    |                                 | --     | --  | 720 | A       |
| $V_{SD}$ | Diode Forward Voltage     | $V_{GS}=0V, I_S=50A$            | --     | --  | 1.2 | V       |
| $T_{rr}$ | Reverse Recovery Time     | $I_S=92.5A,$<br>$di/dt=100A/us$ | --     | 80  | --  | ns      |
| $Q_{rr}$ | Reverse Recovery Charge   |                                 | --     | 195 | --  | $\mu C$ |

Characteristics Curves

Figure 1. Safe Operating Area

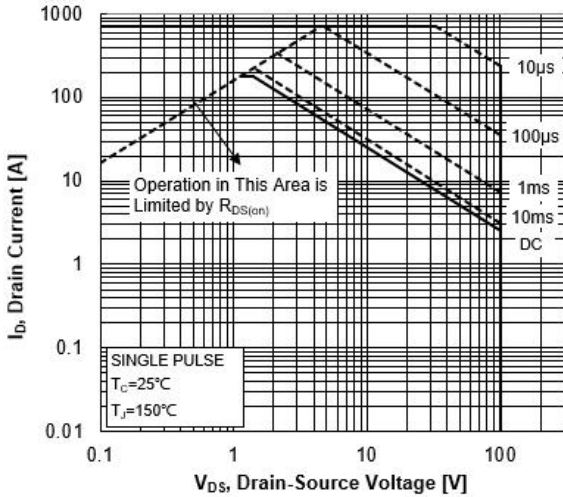

Figure 2. Maximum Power Dissipation vs Case Temperature

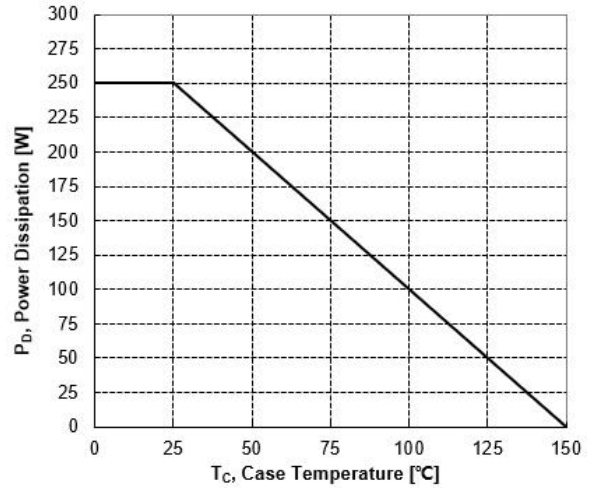

Figure 3. Maximum Continuous Drain Current vs Case Temperature

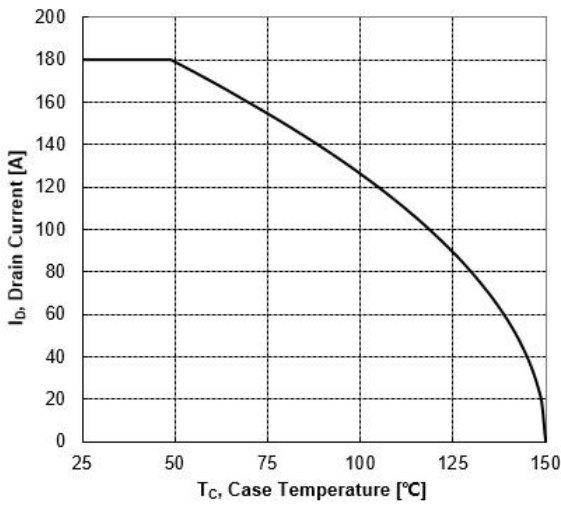

Figure 4. Typical Output Characteristics

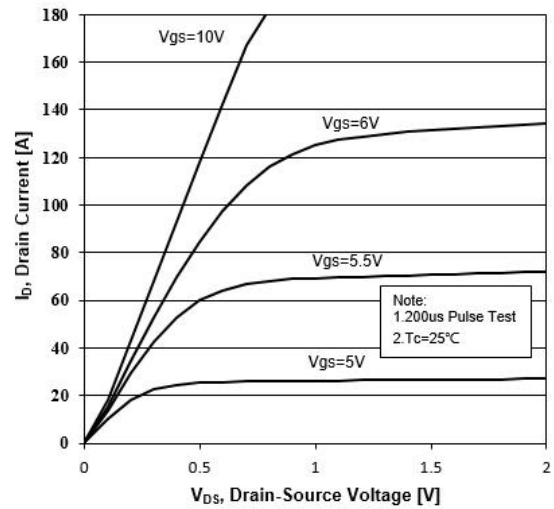

Figure 5. Transient Thermal Impedance

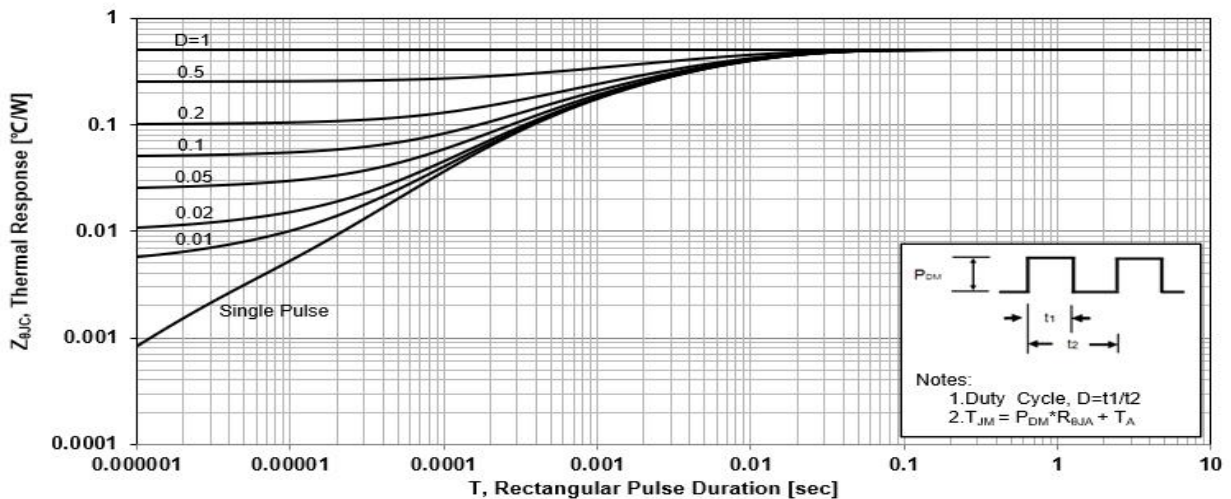

Figure 6. Typical Transfer Characteristics

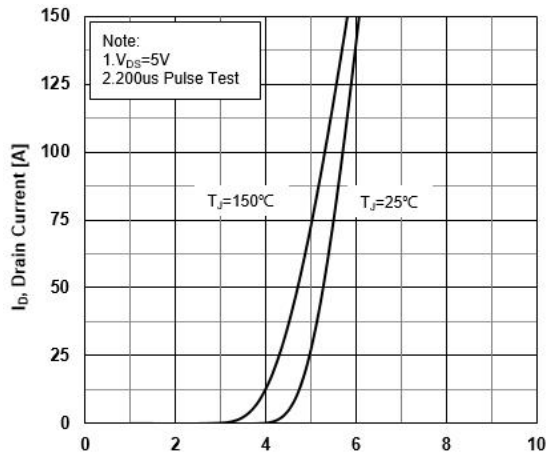

Figure 7. Source-Drain Diode Forward Characteristics

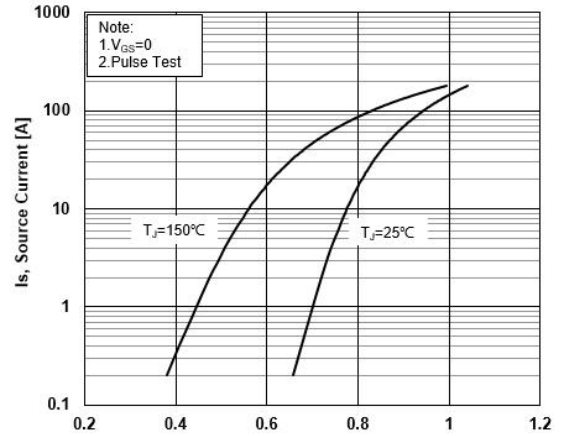

Figure 8. Drain-Source On-Resistance vs Drain Current

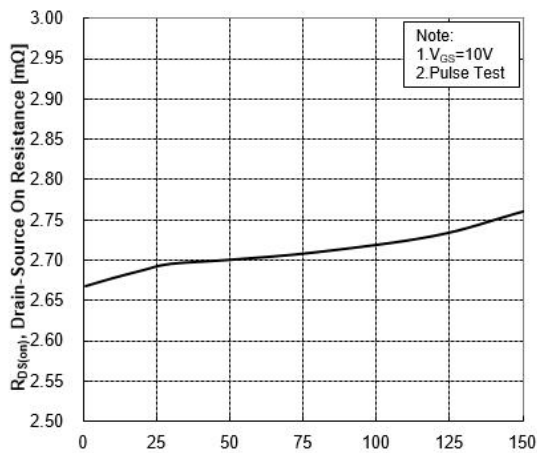

Figure 9. Normalized On-Resistance vs Junction Temperature

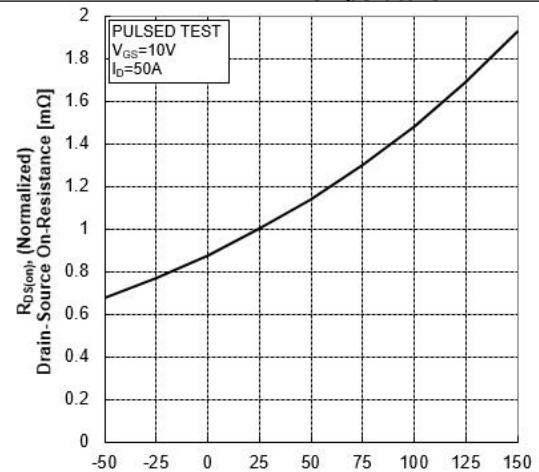

Figure 10. Normalized Threshold Voltage vs Junction Temperature

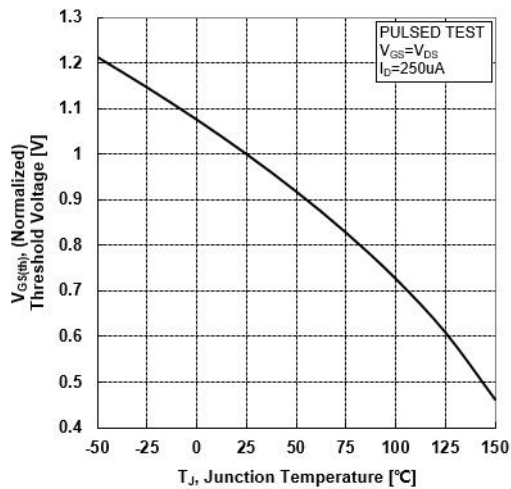

Figure 11. Normalized Breakdown Voltage vs Junction Temperature

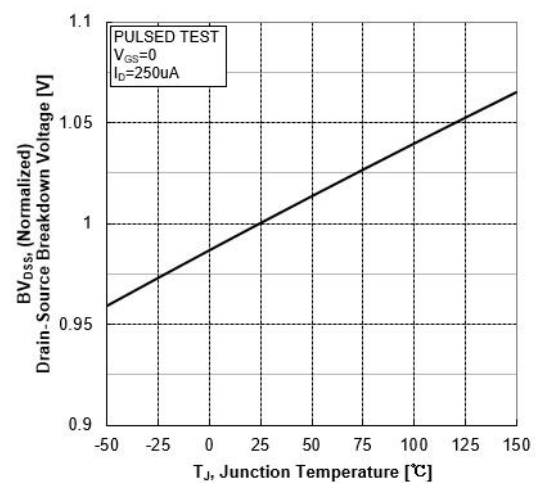

Figure 12. Capacitance Characteristics

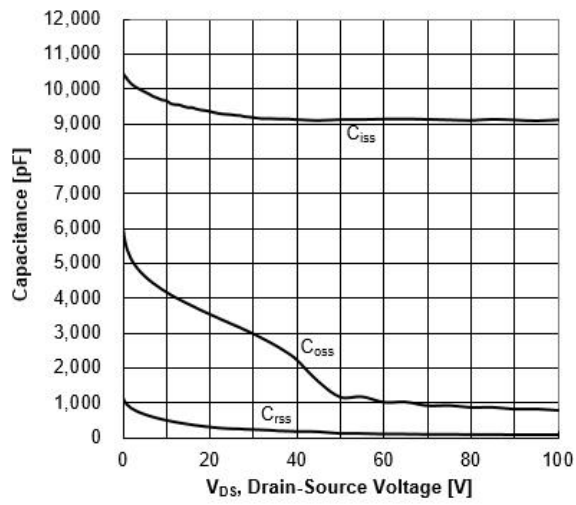
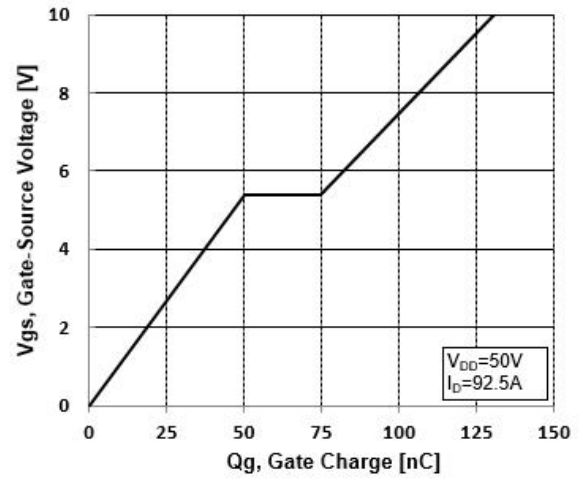
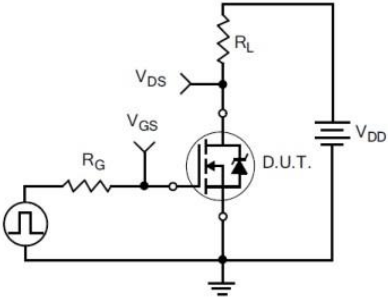
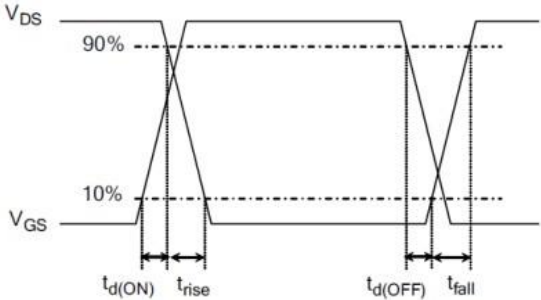
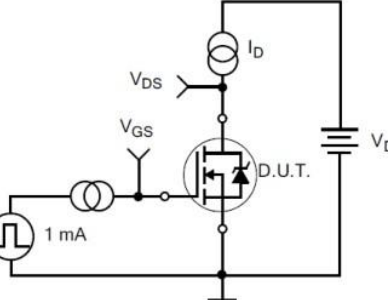
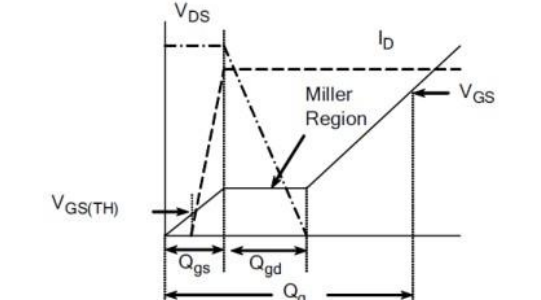
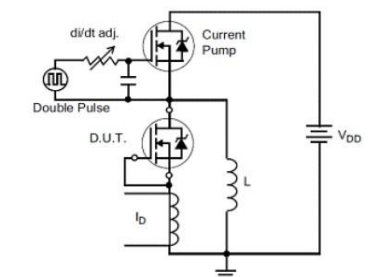
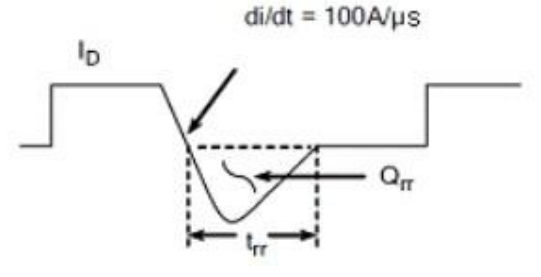
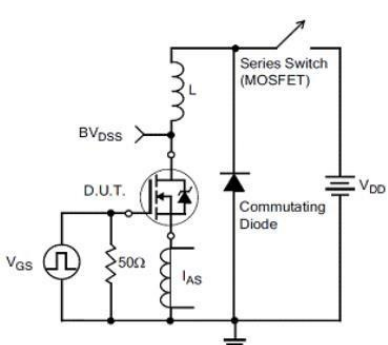
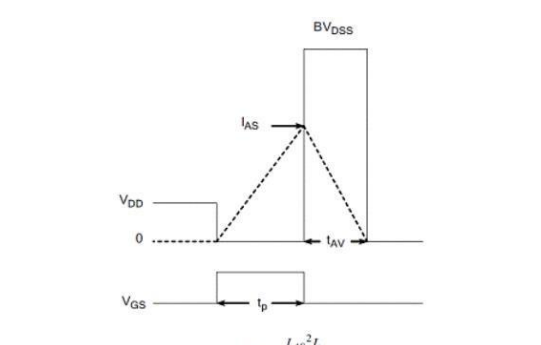

Figure 13. Typical Gate Charge vs Gate-Source Voltage



Test Circuit and Waveform

|   |  |
|---|--|
| <p><b>Figure 14. Resistive Switching Test Circuit</b></p>              | <p><b>Figure 15. Resistive Switching Waveforms</b></p>   |
| <p><b>Figure 16. Gate Charge Test Circuit</b></p>                     | <p><b>Figure 17. Gate Charge Waveforms</b></p>    |
| <p><b>Figure 18. Diode Reverse Recovery Test Circuit</b></p>         | <p><b>Figure 19. Diode Reverse Recovery Waveform</b></p>   |
| <p><b>Figure 20. Unclamped Inductive Switching Test Circuit</b></p>  | <p><b>Figure 21. Unclamped Inductive Switching Waveform</b></p>  $E_{AS} = \frac{I_{AS}^2 L}{2}$ |



Package Descriptio

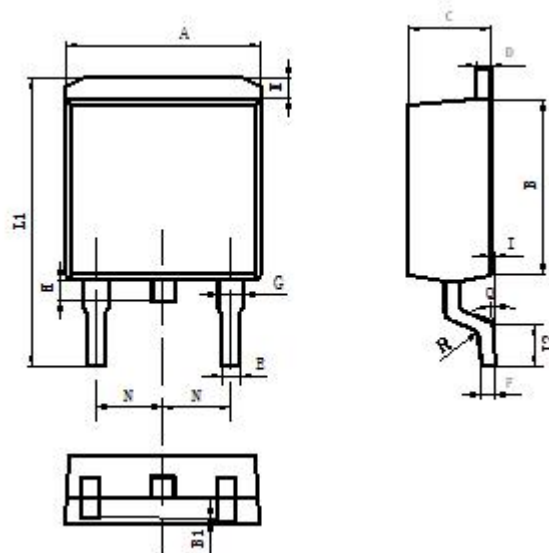

| Items | Values(mm) |       |
|-------|------------|-------|
|       | MIN        | MAX   |
| A     | 9.80       | 10.40 |
| B     | 8.90       | 9.50  |
| B1    | 0          | 0.10  |
| C     | 4.40       | 4.80  |
| D     | 1.16       | 1.37  |
| E     | 0.70       | 0.95  |
| F     | 0.30       | 0.60  |
| G     | 1.07       | 1.47  |
| H     | 1.30       | 1.80  |
| K     | 0.95       | 1.37  |
| L1    | 14.50      | 16.50 |
| L2    | 1.60       | 2.30  |
| I     | 0          | 0.2   |
| Q     | 0°         | 8°    |
| R     | 0.4        |       |
| N     | 2.39       | 2.69  |

TO-263 Package



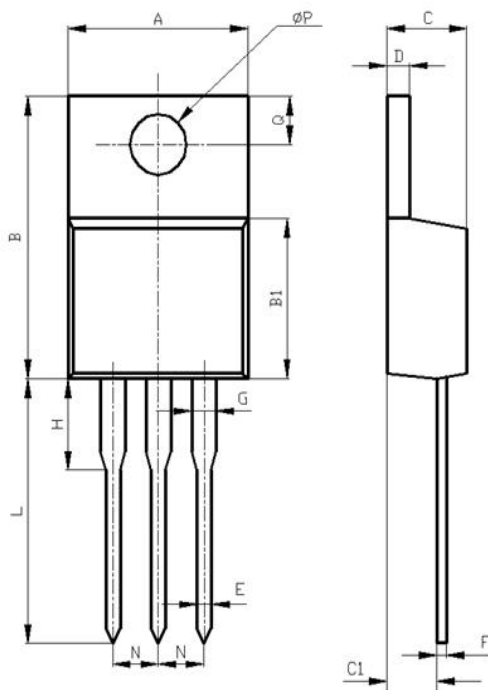

| Items | Values(mm) |      |
|-------|------------|------|
|       | MIN        | MAX  |
| A     | 9.60       | 10.6 |
| B     | 15.0       | 16.0 |
| B1    | 8.90       | 9.50 |
| C     | 4.30       | 4.80 |
| C1    | 2.30       | 3.10 |
| D     | 1.20       | 1.40 |
| E     | 0.70       | 0.90 |
| F     | 0.30       | 0.60 |
| G     | 1.17       | 1.37 |
| H     | 2.70       | 3.80 |
| L     | 12.6       | 14.8 |
| N     | 2.34       | 2.74 |
| Q     | 2.40       | 3.00 |
| Φ P   | 3.50       | 3.90 |

TO-220 Package

[www.mns-kx.com](http://www.mns-kx.com)



**NOTE:**

1. Exceeding the maximum ratings of the device in performance may cause damage to the device, even the permanent failure, which may affect the dependability of the machine. Please do not exceed the absolute maximum ratings of the device when circuit designing.
2. When installing the heat sink, please pay attention to the torsional moment and the smoothness of the heat sink.
3. MOSFETs is the device which is sensitive to the static electricity, it is necessary to protect the device from being damaged by the static electricity when using it.
4. Shenzhen Minos reserves the right to make changes in this specification sheet and is subject to change without prior notice.

**CONTACT:**

**深圳市迈诺斯科技有限公司（总部）**

地址：深圳市福田区华富街道田面社区深南中路4026号田面城市大厦22B-22C

邮编：518025

电话：0755-83273777

## X-ON Electronics

Largest Supplier of Electrical and Electronic Components

*Click to view similar products for [MOSFET](#) category:*

*Click to view products by [Minos](#) manufacturer:*

Other Similar products are found below :

[IRFD120](#) [IRFY240C](#) [JANTX2N5237](#) [2SK2267\(Q\)](#) [BUK455-60A/B](#) [MIC4420CM-TR](#) [VN1206L](#) [NDP4060](#) [SI4482DY](#)  
[IPS70R2K0CEAKMA1](#) [SQD23N06-31L-GE3](#) [TK16J60W,S1VQ\(O](#) [2SK2614\(TE16L1,Q\)](#) [DMN1017UCP3-7](#) [EFC2J004NUZTDG](#)  
[DMN1053UCP4-7](#) [SQJ469EP-T1-GE3](#) [NTE2384](#) [DMC2700UDMQ-7](#) [DMN2080UCB4-7](#) [DMN61D9UWQ-13](#) [US6M2GTR](#)  
[DMN31D5UDJ-7](#) [DMP22D4UFO-7B](#) [DMN1006UCA6-7](#) [DMN16M9UCA6-7](#) [STF5N65M6](#) [IRF40H233XTMA1](#) [STU5N65M6](#)  
[DMN6022SSD-13](#) [DMN13M9UCA6-7](#) [DMTH10H4M6SPS-13](#) [DMN2990UFB-7B](#) [IPB80P04P405ATMA2](#) [2N7002W-G](#) [MCAC30N06Y-](#)  
[TP](#) [MCQ7328-TP](#) [NTMC083NP10M5L](#) [NVMFS2D3P04M8LT1G](#) [BXP7N65D](#) [BXP4N65F](#) [AOL1454G](#) [WMJ80N60C4](#) [BXP2N20L](#)  
[BXP2N65D](#) [BXT1150N10J](#) [BXT1700P06M](#) [TSM60NB380CP](#) [ROG](#) [RQ7L055BGTCR](#) [DMNH15H110SK3-13](#)