

85V N-Channel Power MOSFET

Description

MPT035N08, the N-channel Enhanced Power MOSFETs, is obtained by advanced double trench technology which reduces the conduction loss, improves switching performance and enhances the avalanche energy. This is a suitable device for BMS and high current switching applications.

General Features

- ① $V_{DS}=85V$, $R_{dson}<4m\Omega$ @ $V_{GS}=10V$, $I_D=180A$ (Typ: $3m\Omega$)
- ② Fast Switching
- ③ Low On-Resistance ($R_{DS(on)}\leq 4m\Omega$)
- ④ Low Gate Charge
- ⑤ Low Reverse transfer capacitances
- ⑥ High avalanche ruggedness
- ⑦ RoHS product

Application

- ① BMS
- ② Motor drivers

Package Marking And Ordering Information:

Ordering Codes	Package	Product Code	Packing
MPT035N08-P	TO-220	035N08	Tube
MPT035N08-S	TO-263	035N08	Tape Reel

ABSOLUTE RATINGS at $T_C=25^\circ C$, unless otherwise specified

Symbol	Parameter	Rating	Units
V_{DSS}	Drain-Source Voltage	85	V
I_D	Continuous Drain Current, Silicon Limited	185	A
	Continuous Drain Current, Package Limited	120	A
	Continuous Drain Current @ $T_C=100^\circ C$, Silicon Limited	117.2	A
I_{DM} ^{Note1}	Pulsed Drain Current	480	A
V_{GS}	Gate-Source Voltage	± 20	V
E_{AS} ^{Note2}	Avalanche Energy	240.2	mJ

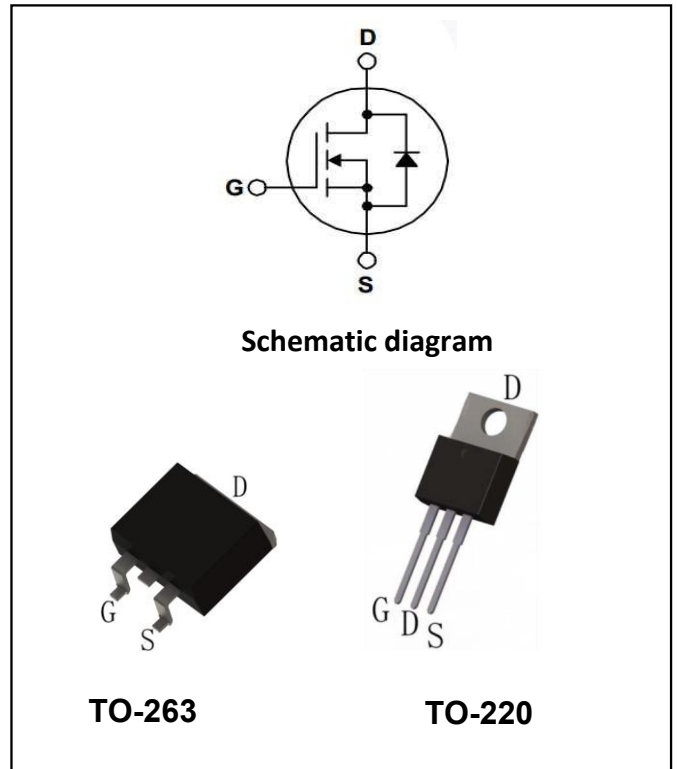



PD	Power Dissipation	208.3	W
	Derating Factor above 25°C	1.67	W/°C
T _J , T _{stg}	Operating Junction and Storage Temperature Range	150, -55 to 150	°C
T _L	Maximum Temperature for Soldering	260	°C

Note1: Repetitive Rating: Pulse width limited by maximum junction temperature Note2:
L=0.5mH, I_{as}=35A, Start T_J=25°C

Thermal characteristics

Symbol	Parameter	Max	Units
R _{θJC}	thermal resistance, Junction-Case	0.5	°C/W
R _{θJA}	thermal resistance, Junction-Ambient	62.5	°C/W

Electrical Characteristics at TC=25°C, unless otherwise specified

OFF Characteristics						
Symbol	Parameter	Test Conditions	Values			Units
			Min	Typ	Max	
V _{DSS}	Drain-Source Breakdown Voltage	V _{GS} =0V, I _D =250μA	85	95	--	V
I _{DSS}	Drain-Source Leakage Current	V _{DS} =100V, V _{GS} =0V	--	--	1	μA
		V _{DS} =80V, V _{GS} =0V @T _C =125°C	--	--	100	μA
I _{GSS(F)}	Gate-Source Forward Leakage	V _{GS} =+20V	--	--	100	nA
I _{GSS(R)}	Gate-Source Reverse Leakage	V _{GS} =-20V	--	--	-100	nA

ON Characteristics						
Symbol	Parameter	Test Conditions	Values			Unit s
			Min	Typ	Max	
R _{DSS(on)}	Drain-Source On-Resistance	V _{GS} =10V, I _D =50A	--	3	4	mΩ
V _{GS(th)}	Gate Threshold Voltage	V _{DS} =V _{GS} , I _D =250μA	2.0	3.0	4.0	V
Pulse width tp≤300μs, δ≤2%						

Dynamic Characteristics						
Symbol	Parameter	Test Conditions	Values			Units
			Min	Typ	Max	
C_{iss}	Input Capacitance	$V_{DS}=42.5V,$ $V_{GS}=0,$ $f=1MHz$	--	6234	--	pF
C_{oss}	Output Capacitance		--	1181	--	
C_{rss}	Reverse Transfer Capacitance		--	97	--	
Q_g	Total Gate Charge	$V_{DD}=42.5V,$ $I_D=50A,$ $V_{GS}=10V$	--	124	--	nC
Q_{gs}	Gate-Source charge		--	31.2	--	
Q_{gd}	Gate-Drain charge		--	39.2	--	

Switching Characteristics						
Symbol	Parameter	Test Conditions	Values			Units
			Min	Typ	Max	
$t_{d(on)}$	Turn-On Delay Time	$V_{DD}=42.5V, I_D=10A,$ $V_{GS}=10V, R_G=3\Omega,$ Resistive Load	--	41	--	ns
t_r	Rise Time		--	68	--	
$t_{d(off)}$	Turn-Off Delay Time		--	76	--	
t_f	Fall Time		--	44	--	

Source-Drain Diode Characteristics						
Symbol	Parameter	Test Conditions	Values			Units
			Min	Typ	Max	
I_S	Continuous Source Current		--	--	120	A
I_{SM}	Maximum Pulsed Current		--	--	480	A
V_{SD}	Diode Forward Voltage	$V_{GS}=0V, I_S=50A$	--	--	1.2	V
T_{rr}	Reverse Recovery Time	$I_S=30A,$ $di/dt=100A/us$	--	80	--	ns
Q_{rr}	Reverse Recovery Charge		--	112	--	uC

Characteristics Curves

Figure 1. Safe Operating Area

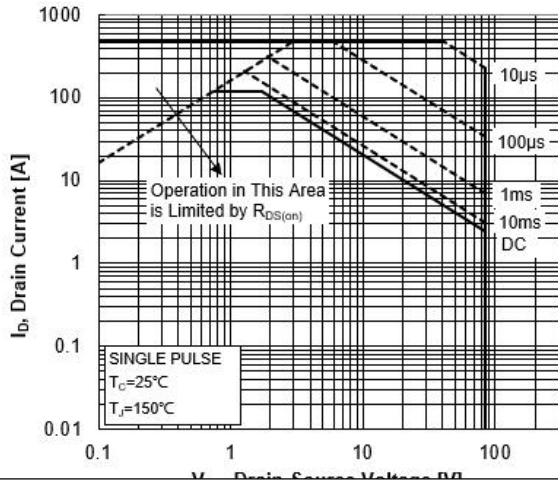

Figure 2. Maximum Power Dissipation vs Case

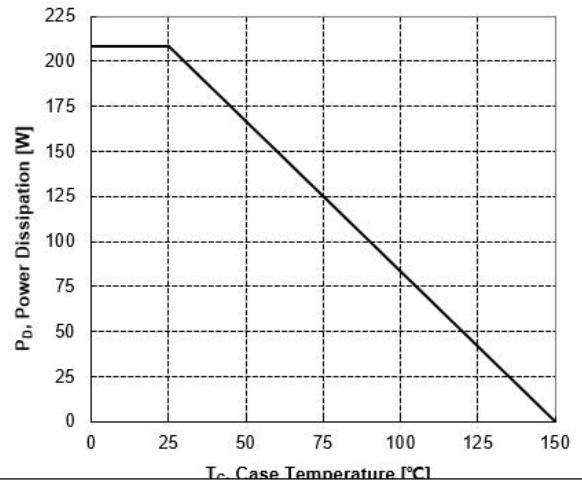

Figure 3. Maximum Continuous Drain Current vs Case Temperature

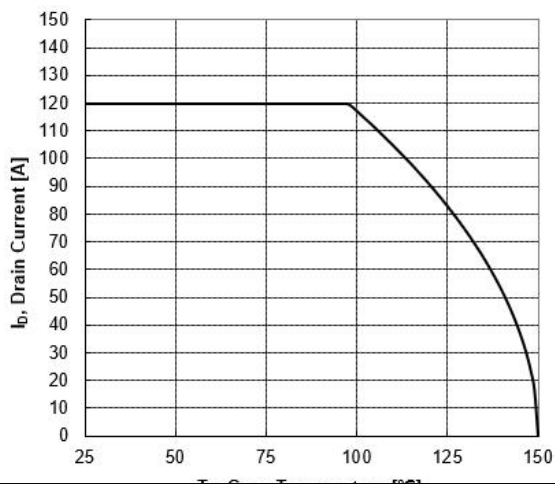

Figure 4. Typical Output Characteristics

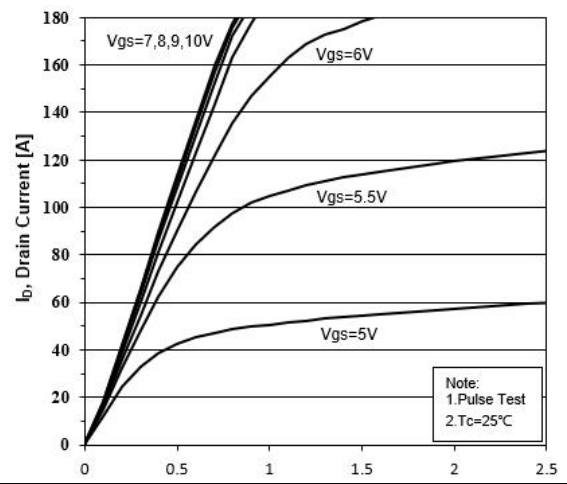

Figure 5. Transient Thermal Impedance

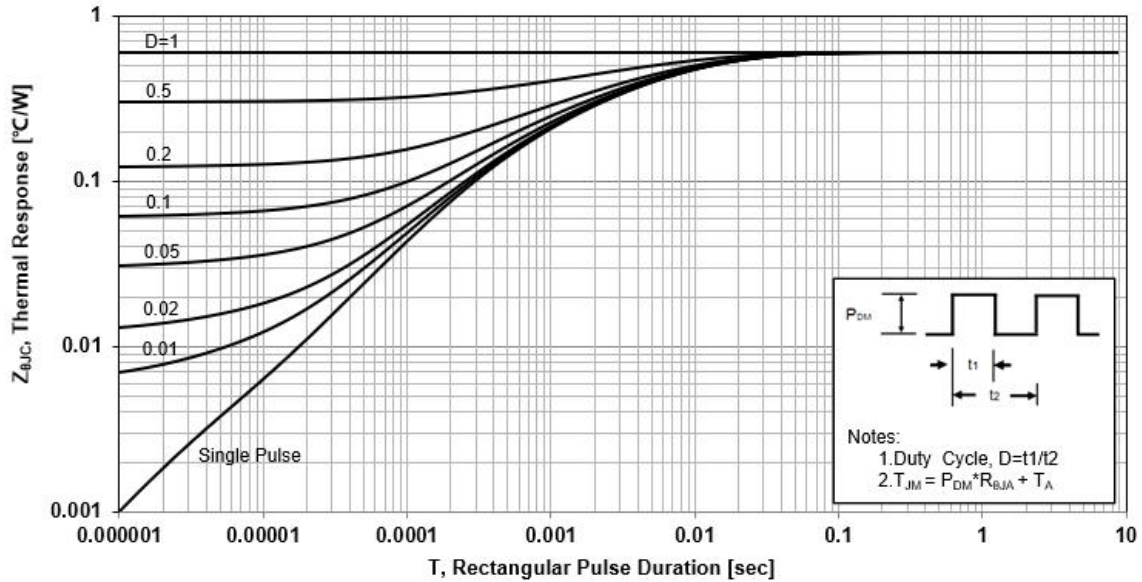

Figure 6. Typical Transfer Characteristics

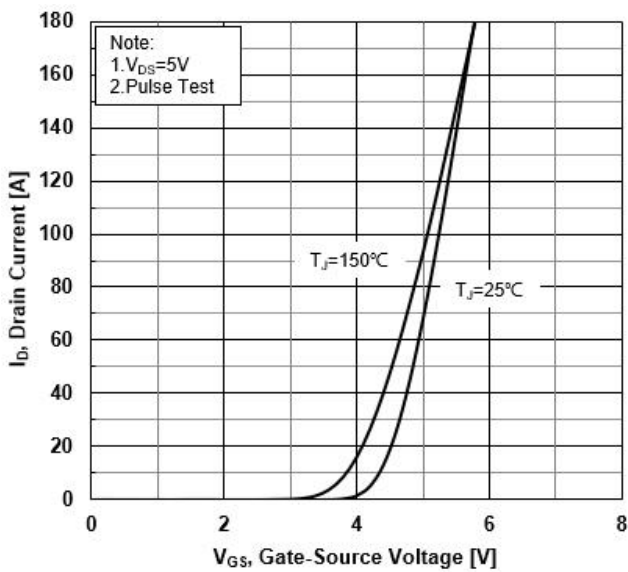

Figure 7. Source-Drain Diode Forward Characteristics

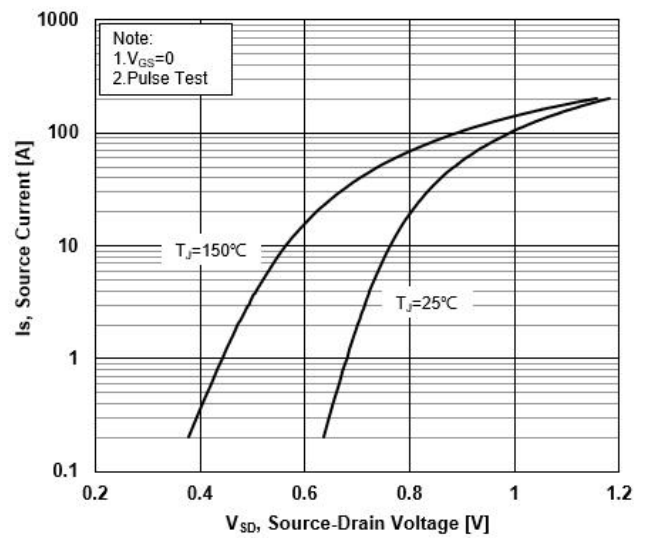

Figure 8. Drain-Source On-Resistance vs Drain Current

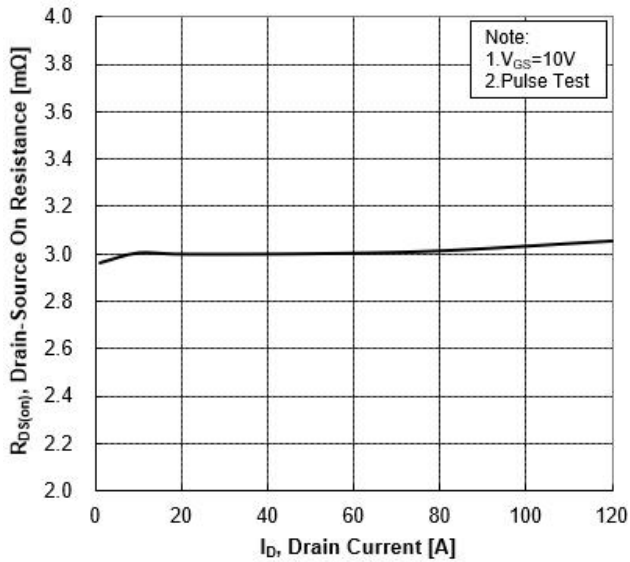

Figure 9. Normalized On-Resistance vs Junction Temperature

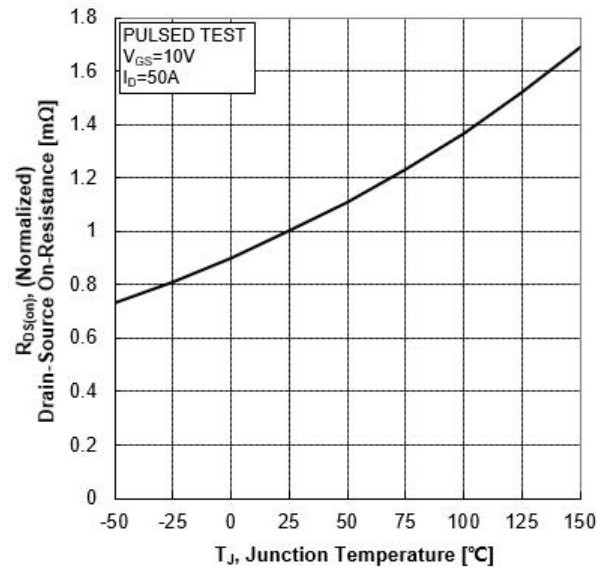

Figure 10. Normalized Threshold Voltage vs Junction Temperature

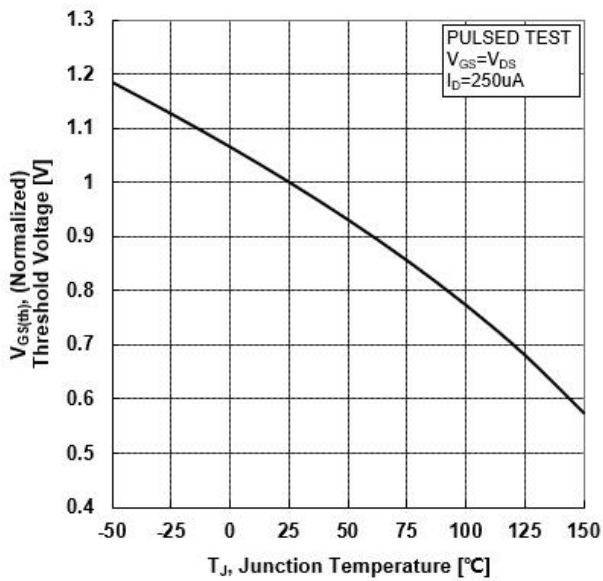

Figure 11. Normalized Breakdown Voltage vs Junction Temperature

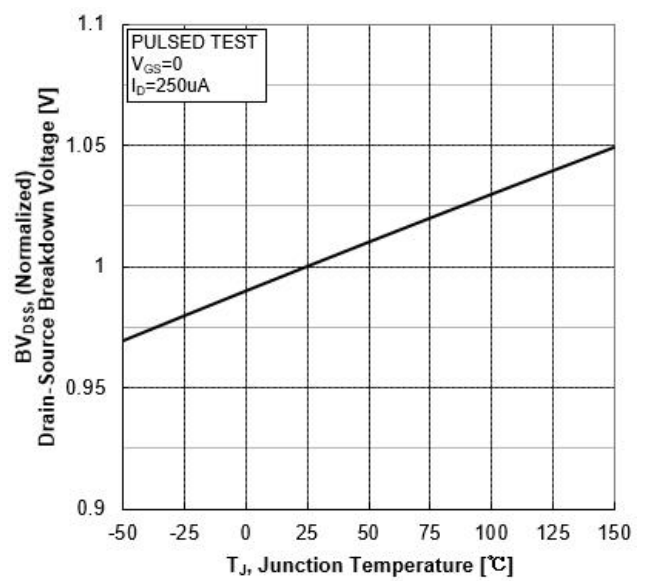

Figure 12. Capacitance Characteristics

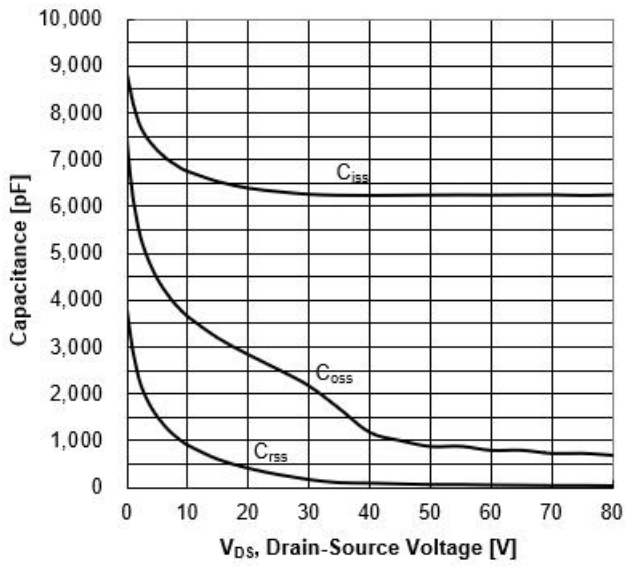
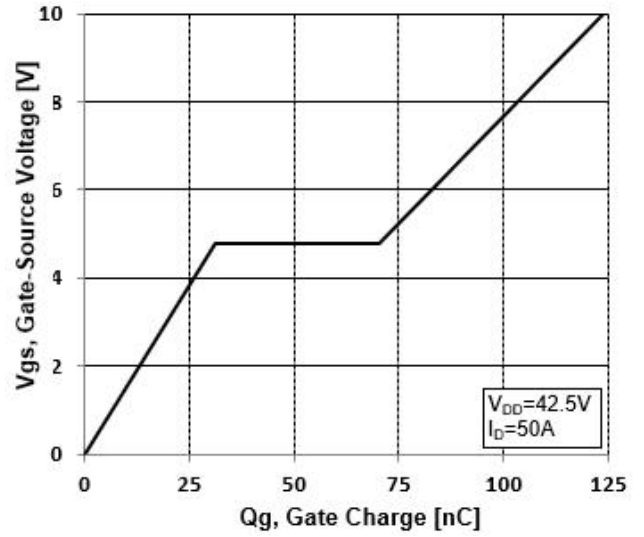
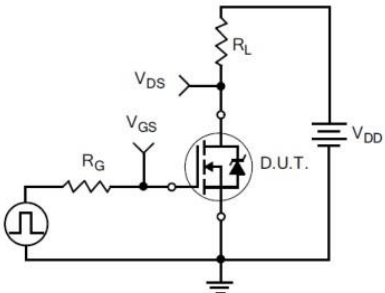
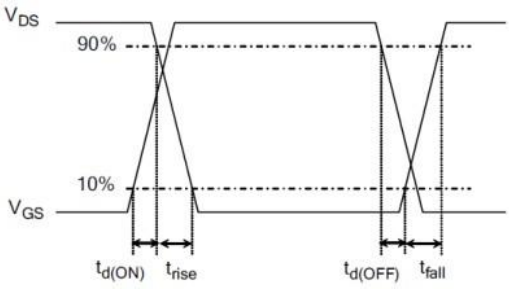
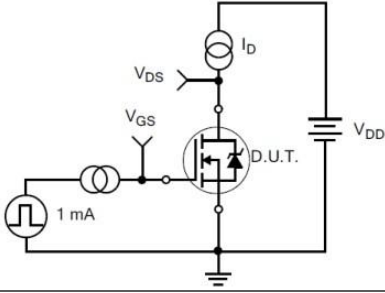
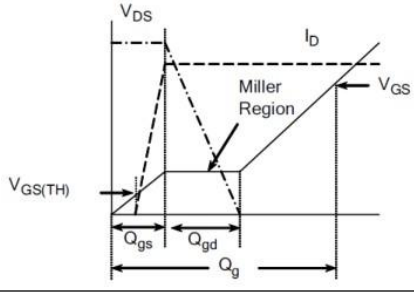
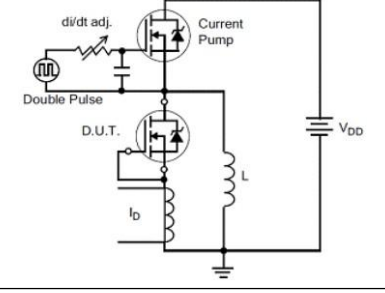
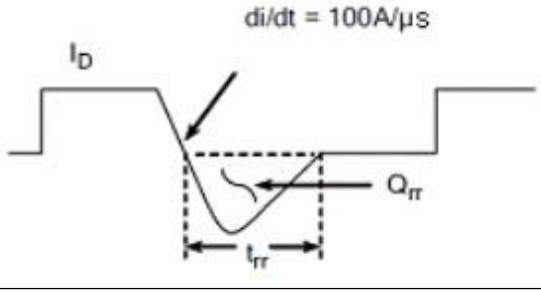
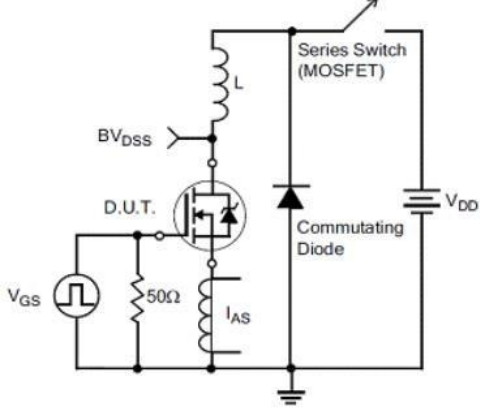
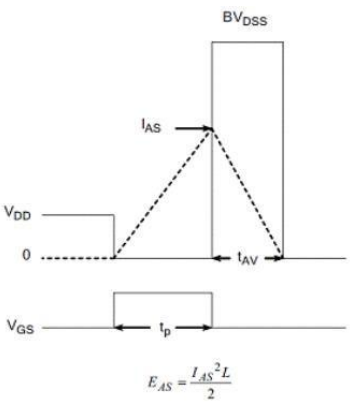

Figure 13. Typical Gate Charge vs Gate-Source Voltage



Test Circuit and Waveform

<p>Figure 14. Resistive Switching Test Circuit</p> 	<p>Figure 15. Resistive Switching Waveforms</p> 
<p>Figure 16. Gate Charge Test Circuit</p> 	<p>Figure 17. Gate Charge Waveforms</p> 
<p>Figure 18. Diode Reverse Recovery Test Circuit</p> 	<p>Figure 19. Diode Reverse Recovery Waveform</p> 
<p>Figure 20. Unclamped Inductive Switching Test Circuit</p> 	<p>Figure 21. Unclamped Inductive Switching Waveform</p> 

Package Description

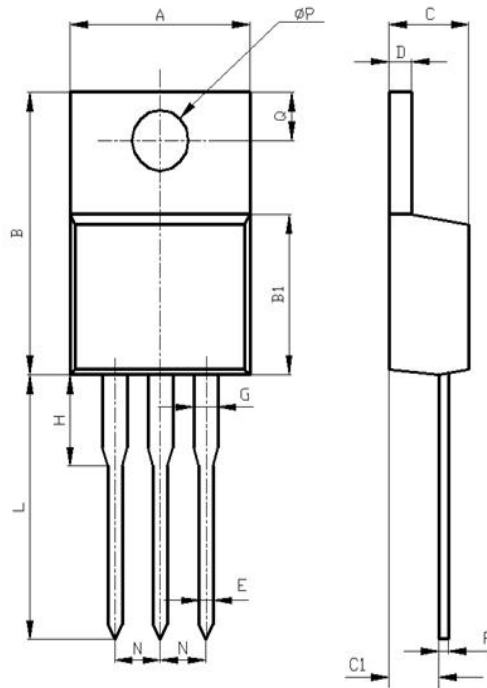

Items	Values(mm)	
	MIN	MAX
A	9.60	10.6
B	15.0	16.0
B1	8.90	9.50
C	4.30	4.80
C1	2.30	3.10
D	1.20	1.40
E	0.70	0.90
F	0.30	0.60
G	1.17	1.37
H	2.70	3.80
L	12.6	14.8
N	2.34	2.74
Q	2.40	3.00
φ P	3.50	3.90

TO-220 Package

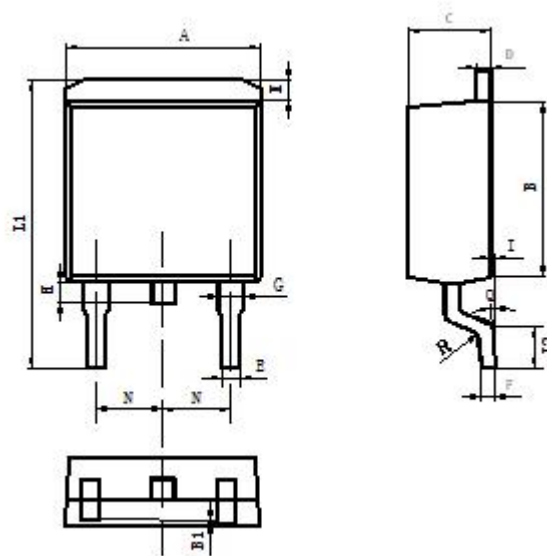

Items	Values(mm)	
	MIN	MAX
A	9.80	10.40
B	8.90	9.50
B1	0	0.10
C	4.40	4.80
D	1.16	1.37
E	0.70	0.95
F	0.30	0.60
G	1.07	1.47
H	1.30	1.80
K	0.95	1.37
L1	14.50	16.50
L2	1.60	2.30
I	0	0.2
Q	0°	8°
R	0.4	
N	2.39	2.69

TO-263 Package



NOTE:

1. Exceeding the maximum ratings of the device in performance may cause damage to the device, even the permanent failure, which may affect the dependability of the machine. Please do not exceed the absolute maximum ratings of the device when circuit designing.
2. When installing the heat sink, please pay attention to the torsional moment and the smoothness of the heat sink.
3. MOSFETs is the device which is sensitive to the static electricity, it is necessary to protect the device from being damaged by the static electricity when using it.
4. Shenzhen Minos reserves the right to make changes in this specification sheet and is subject to change without prior notice.

CONTACT:

深圳市迈诺斯科技有限公司（总部）

地址：深圳市福田区华富街道田面社区深南中路4026号田面城市大厦22B-22C

邮编：518025

电话：0755-83273777

X-ON Electronics

Largest Supplier of Electrical and Electronic Components

Click to view similar products for [MOSFET](#) category:

Click to view products by [Minos](#) manufacturer:

Other Similar products are found below :

[IRFD120](#) [IRFY240C](#) [JANTX2N5237](#) [2SK2267\(Q\)](#) [BUK455-60A/B](#) [MIC4420CM-TR](#) [VN1206L](#) [NDP4060](#) [SI4482DY](#)
[IPS70R2K0CEAKMA1](#) [SQD23N06-31L-GE3](#) [TK16J60W,S1VQ\(O](#) [2SK2614\(TE16L1,Q\)](#) [DMN1017UCP3-7](#) [EFC2J004NUZTDG](#)
[DMN1053UCP4-7](#) [SQJ469EP-T1-GE3](#) [NTE2384](#) [DMC2700UDMQ-7](#) [DMN2080UCB4-7](#) [DMN61D9UWQ-13](#) [US6M2GTR](#)
[DMN31D5UDJ-7](#) [DMP22D4UFO-7B](#) [DMN1006UCA6-7](#) [DMN16M9UCA6-7](#) [STF5N65M6](#) [IRF40H233XTMA1](#) [STU5N65M6](#)
[DMN6022SSD-13](#) [DMN13M9UCA6-7](#) [DMTH10H4M6SPS-13](#) [DMN2990UFB-7B](#) [IPB80P04P405ATMA2](#) [2N7002W-G](#) [MCAC30N06Y-](#)
[TP](#) [MCQ7328-TP](#) [NTMC083NP10M5L](#) [NVMFS2D3P04M8LT1G](#) [BXP7N65D](#) [BXP4N65F](#) [AOL1454G](#) [WMJ80N60C4](#) [BXP2N20L](#)
[BXP2N65D](#) [BXT1150N10J](#) [BXT1700P06M](#) [TSM60NB380CP](#) [ROG](#) [RQ7L055BGTCR](#) [DMNH15H110SK3-13](#)