

REV.	EQN. NO.	APPD.
A		

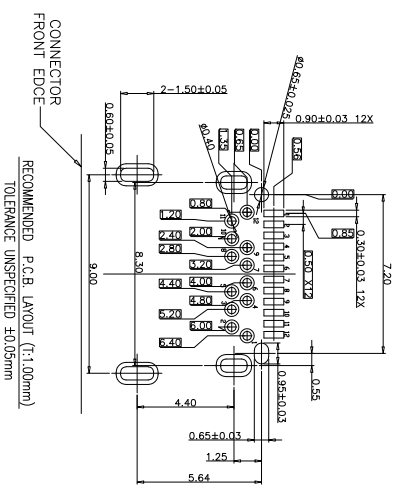
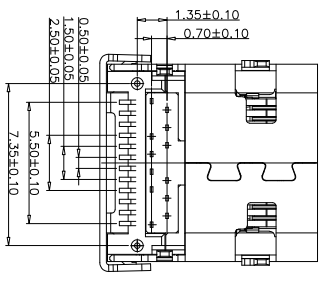
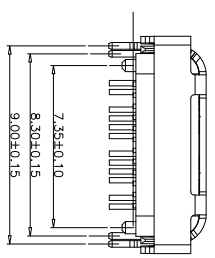
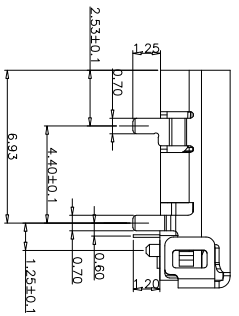
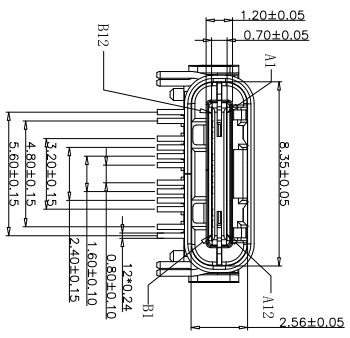
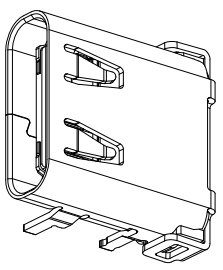
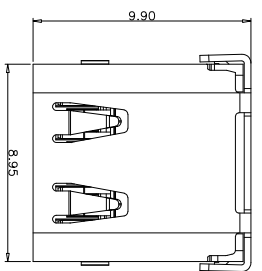

- NOTES:
- MATERIAL:
 - MOLDING: LCP UL94 V-0
 - CONTACT:C1814
 - GOLD PLATED 1U" Min ON CONTACT AREA,
 - 100U" Min TIN ON SOLDER AREA,
 - 50U" NICKEL PLATING OVER ALL.
 - SHELL: SUS304-H,T=0.30±0.03mm
 - 50U" NICKEL PLATING OVER ALL.
 - SHLD.S:SUS301-H,T=0.20±0.03mm
- MECHANICAL:
 - INSERTION: 5~20N,
 - EXTRACTION: 8~20N AFTER TEST.
 - DURABILITY: 10000 CYCLES
 - ELECTRICAL:
 - CURRENT: 5A FOR VBUS,
 - 1.25A FOR GND PIN,
 - 0.25A FOR OTHER.
 - VOLTAGE: 20 V MAX
 - WITHSTANDING VOLTAGE: 100V AC R.M.S.
 - CONTACT RESISTANCE: 40mΩ MAX.
 - INSULATION RESISTANCE: 100MΩ MIN.
 - ENVIRONMENTAL
 - TEMPERATURE RANGE -25°C ~ +85°C

A1	GND	B12	GND
A2	SSTXP1	B11	SSRXP1
A3	SSTXN1	B10	SSRXN1
A4	VBUS	B9	VBUS
A5	CC1	B8	SBU2
A6	DP1	B7	DN2
A7	DN1	B6	DP2
A8	SBU1	B5	CC2
A9	VBUS	B4	VBUS
A10	SSRXN2	B3	SSTXN2
A11	SSRXP2	B2	SSTXP2
A12	GND	B1	GND
PIN	SIGNAL NAME	PIN	SIGNAL NAME

NO	DESCRIPTION	MATERIAL	REMARKS	QTY
1	端子	LCP UL94V-0	BLACK	1PCS
2	端子	C1814, T=0.12	Au/Ni Plated	2SET
3	垫片	SUS 304, T=0.20	---	1PCS
4	垫片	SUS 316, T=0.10	---	1PCS
5	接蓋	SUS 201, T=0.30	Ni Plated	1PCS

MINTRON CO., LTD.

NAME:(INTENDED USE)
 PART NO.(INTENDED USE)
 TITLE: TYPE C母座2排板上前推后贴半包式=9.87

APPD: SUNNY
 CHKD: LISA
 DR: ZOE 2022-06-10

DWG NO.: 00302-UCAP005-A
 SCALE 1/1
 SHEET 1/1
 REV. A

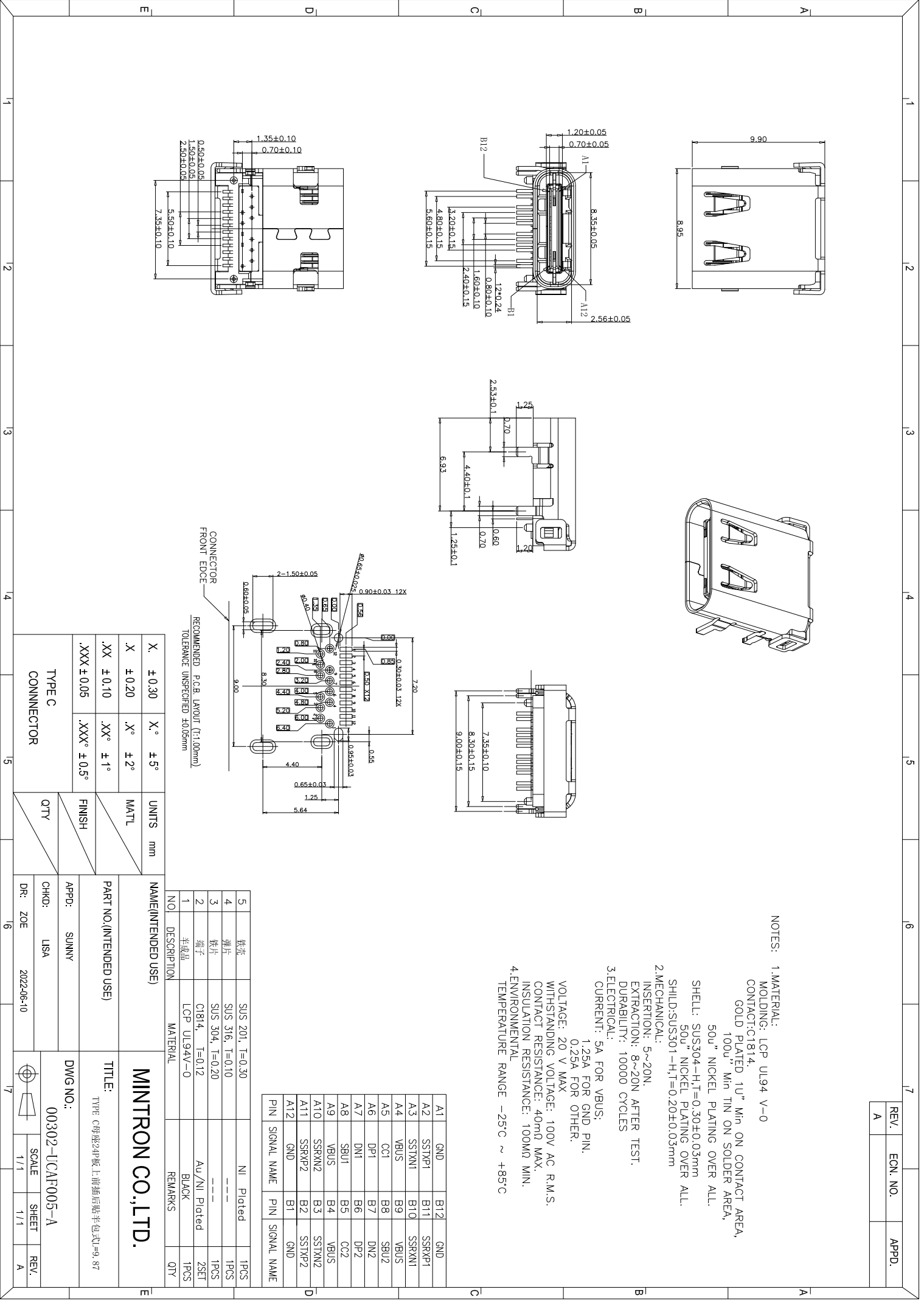

X-ON Electronics

Largest Supplier of Electrical and Electronic Components

Click to view similar products for [USB Connectors](#) category:

Click to view products by [MINTRON](#) manufacturer:

Other Similar products are found below :

[950](#) [A-USB B-TOP-C](#) [MUSBA511N5](#) [MUSBC111M5](#) [MUSBD11135](#) [17-200721](#) [217450-1](#) [KMBVX-TH-5S-B30](#) [896-30-004-00-000000](#)
[KUSBX-AS2N-W](#) [KUSBX-SMT2AP1S-W30](#) [935](#) [957](#) [30-498-6](#) [SK-60A-2](#) [1734082-1](#) [CIR06R-18-12S-F80-T12-26](#) [CIR08F-20](#) [30-1574](#)
[30-470](#) [30-489](#) [30-541](#) [MAB 5 S](#) [A-USB A-2P-C](#) [MIKROE-1451](#) [USBFTV2PEM2G](#) [USBFTVC6ZN](#) [USBFTVSCCG](#) [4689-1](#) [1-1734084-2](#)
[MUSBC11135](#) [CIR08F-20-27P-F80-VO](#) [USBF21ZNSCC](#) [USBBFTV6ZC](#) [10135326-001LF](#) [M9177/3-1](#) [USB-A-S-F-B-VT](#) [4198](#) [1310-1018-](#)
[05](#) [690-024-633-031](#) [UB-20PMFP-LC7001](#) [UA-20BMFA-SL8001](#) [17-200011](#) [USBFTVC7ZC](#) [UB-20AFMM-LL7A01](#) [USBFTVC2MN](#)
[CAP-WCCMLPB1](#) [CAP-WCCMLPC1](#) [1310-1031-01](#) [2041386-1](#)