

REV	ECH. NO.	APPD.
A		

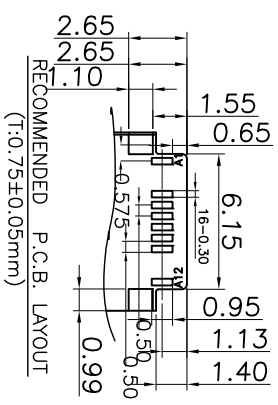
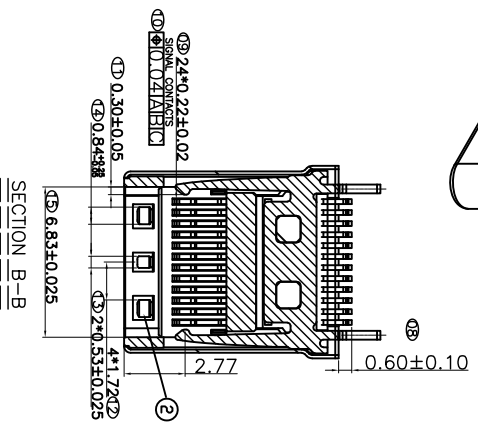
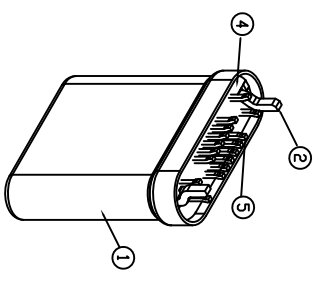
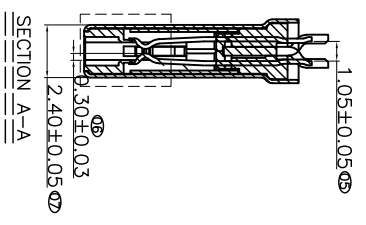
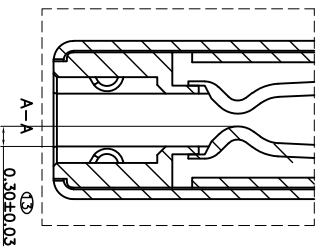
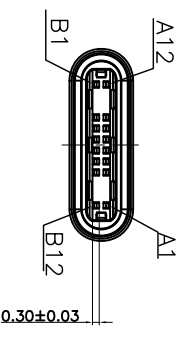
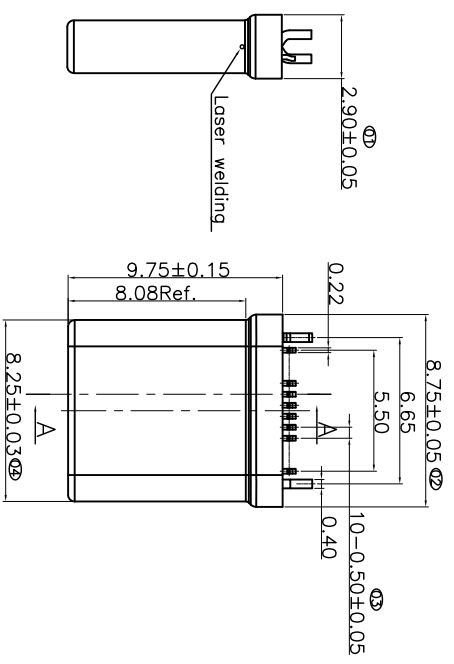
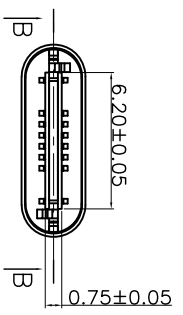

NO.	DESCRIPTION	MATERIAL	COLOR	REMARK
1	Shell	STAINLESS STEEL	—	Ni Plated
2	Terminal	COPPER ALLOY	—	Gold Plated
3	Latch	STAINLESS STEEL	—	SN Plated
4	Molding	HIGH TEMP	BLACK	UL 94V-0
5	Housing	HIGH TEMP	WHITE	UL 94V-0

X.	±0.30	X°	±5°	UNITS	mm
X	±0.20	X°	±2°	MATL	
XX	±0.10	XX°	±1°		
XXX	±0.05	XXX°	±0.5°	FINISH	

TYPE C CONNECTOR		QTY	NAME(INTENDED USE)	TITLE:
				TYPE C公头16P不带板(华为款)无孔
				DWG NO.:
				24007-UCAM001-B
APPD:	SUNNY	CHKD:	USA	SCALE
DR:	ZOE			1/1
				SHEET
				1/1
				REV.
				A

MINTRON CO., LTD.

X-ON Electronics

Largest Supplier of Electrical and Electronic Components

Click to view similar products for [USB Connectors](#) category:

Click to view products by [MINTRON](#) manufacturer:

Other Similar products are found below :

[950](#) [A-USB B-TOP-C](#) [MUSBA511N5](#) [MUSBC111M5](#) [MUSBD11135](#) [17-200721](#) [217450-1](#) [KMBVX-TH-5S-B30](#) [896-30-004-00-000000](#)
[KUSBX-AS2N-W](#) [KUSBX-SMT2AP1S-W30](#) [935](#) [957](#) [30-498-6](#) [SK-60A-2](#) [1734082-1](#) [30-1574](#) [30-470](#) [30-489](#) [30-541](#) [A-USB A-2P-C](#)
[MIKROE-1451](#) [USBFTV2PEM2G](#) [USBFTVSCCG](#) [4689-1](#) [1-1734084-2](#) [MUSBC11135](#) [USBF21ZNSCC](#) [USBBFTV6ZC](#) [MUSBB151341](#)
[10135326-001LF](#) [M9177/3-1](#) [TJ-105](#) [USB-A-S-F-B-VT](#) [4198](#) [690-024-633-031](#) [UB-20PMFP-LC7001](#) [USBFTVC6MRG](#) [UA-20BMFA-](#)
[SL8001](#) [17-200011](#) [USBFTVC7ZC](#) [UB-20AFMM-LL7A01](#) [USBFTVC2MN](#) [CAP-WCCMLPB1](#) [1310-1031-01](#) [2041386-1](#) [2274475-3](#) [UB-](#)
[20BMFA-SL8001](#) [UB-20PMFP-SC8003](#) [914-614A2025S10200](#)