

REV.	ECN NO.	APPD.
A		

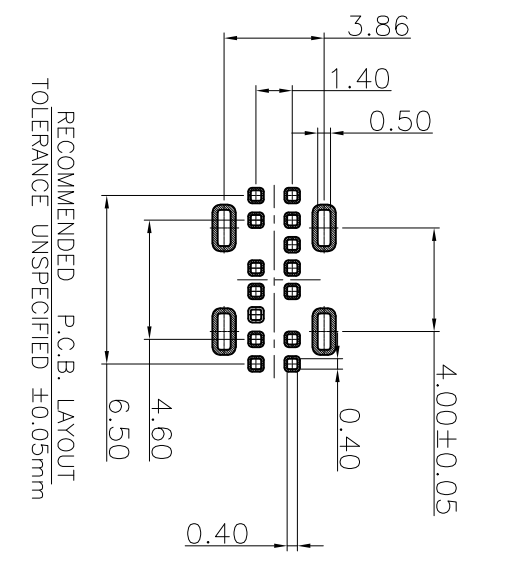
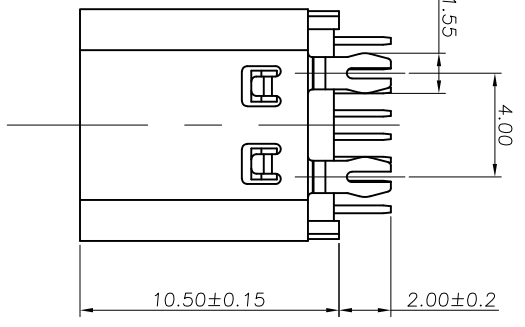

RECOMMENDED P.C.B. LAYOUT  
TOLERANCE UNSPECIFIED ±0.05mm

- 备注:
1. 材质及电镀: 见附表1
  2. 电气性能:
    - 2.1 接触电阻: 30mΩ Max FOR INITIAL. 40mΩ Max AFTER TEST.
    - 2.2 耐电压: 100V AC
    - 2.3 绝缘: 100MΩ Min
    - 2.4 额定电流:
  3. 机械性能:
    - 3.1 插入力: 5~20N.
    - 3.2 拔出力: 初始值8~20N测试后6~20N
    - 3.3 寿命: 10,000 CYCLES
  4. 工作温度: -40° C ~ 80° C.

COLLECTIVELY VBUS PIN (A4,A9,B4,B9) ,TOTAL 5A  
VCCON PIN (B5) THROUGH GND PIN(A1,A12,B1,B12),1.25A

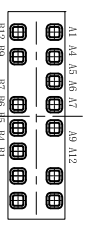
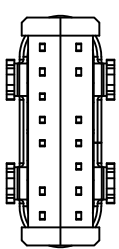
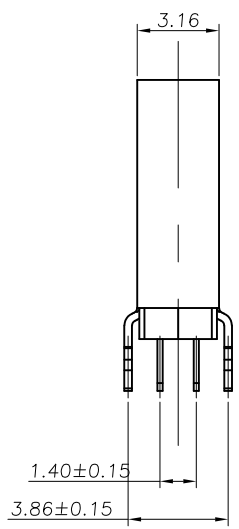
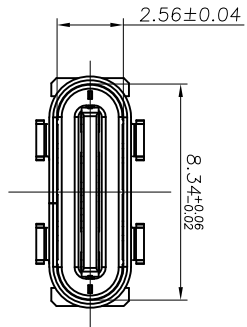

A1	GND	B12	GND
A4	VBUS	B9	VBUS
A5	CCI	B7	DN2
A6	DP1	B6	DP2
A7	DMT	B5	CC2
A9	VBUS	B4	VBUS
A12	GND	B1	GND
PIN	SIGNAL NAME	PIN	SIGNAL NAME

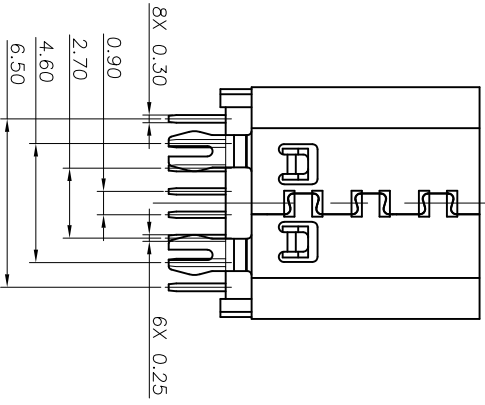

05	外壳	不锈钢	1	SUS 304 1/2H,10,30
04	二次Molding件	LCP	1	黑色 U194 V-0
03	一次Molding件	LCP	1	黑色 U194 V-0
02	中夹片	SUS301-H T=0.15	1	不电镀
01	端子	C18400-H T=0.20	1set	功能接触区镀金, 焊脚镀镍
	序号 品名	材质	用量	备注

X.	±0.30	X.°	±5°	UNITS	mm
.X	±0.20	.X.°	±2°	MAT'L	
.XX	±0.10	.XX.°	±1°		
.XXX	±0.05	.XXX.°	±0.5°	FINISH	

TYPE C CONNECTOR	QTY
------------------	-----

NAME/(INTENDED USE)	PART NO. (INTENDED USE)	TITLE:
		TYPE C 14P母座180度插板H=10.5
APPD: SUNNY	CHKD: USA	DWG NO.: 26003-UCAF002-X
DR: ZOE	2022-06-10	SCALE 1/1
		SHEET 1/1
		REV. A

**MINTRON CO.,LTD.**

## X-ON Electronics

Largest Supplier of Electrical and Electronic Components

*Click to view similar products for [USB Connectors](#) category:*

*Click to view products by [MINTRON](#) manufacturer:*

Other Similar products are found below :

[950](#) [A-USB B-TOP-C](#) [MUSBA511N5](#) [MUSBC111M5](#) [MUSBD11135](#) [17-200721](#) [217450-1](#) [KMBVX-TH-5S-B30](#) [896-30-004-00-000000](#)  
[KUSBX-AS2N-W](#) [KUSBX-SMT2AP1S-W30](#) [935](#) [957](#) [30-498-6](#) [SK-60A-2](#) [1734082-1](#) [30-1574](#) [30-470](#) [30-489](#) [30-541](#) [A-USB A-2P-C](#)  
[MIKROE-1451](#) [USBFTV2PEM2G](#) [USBFTVSCCG](#) [4689-1](#) [1-1734084-2](#) [MUSBC11135](#) [USBF21ZNSCC](#) [USBBFTV6ZC](#) [MUSBB151341](#)  
[10135326-001LF](#) [M9177/3-1](#) [TJ-105](#) [USB-A-S-F-B-VT](#) [4198](#) [690-024-633-031](#) [UB-20PMFP-LC7001](#) [USBFTVC6MRG](#) [UA-20BMFA-](#)  
[SL8001](#) [17-200011](#) [USBFTVC7ZC](#) [UB-20AFMM-LL7A01](#) [USBFTVC2MN](#) [CAP-WCCMLPB1](#) [1310-1031-01](#) [2041386-1](#) [2274475-3](#) [UB-](#)  
[20BMFA-SL8001](#) [UB-20PMFP-SC8003](#) [914-614A2025S10200](#)