

REV.	ECN. NO.	APPD.
A		

NOTES:

Current Rating: 3.0AMP
 Contact Resistance: 20mΩ Max
 Insulation Resistance: 1000MΩ Min
 Withstand Voltage: 1000V AC/Minute
 Operation Temperature: -40°C to +105°C

Contact Material: Brass
 Contact plating: Sn or Au Over Ni
 Insulator Material: PBT or PA6T+30%GF(UL94V-0)
 No side slot "A" and "B" from 6 to 16Pin
 No side slot "A" from 18 to 58Pin

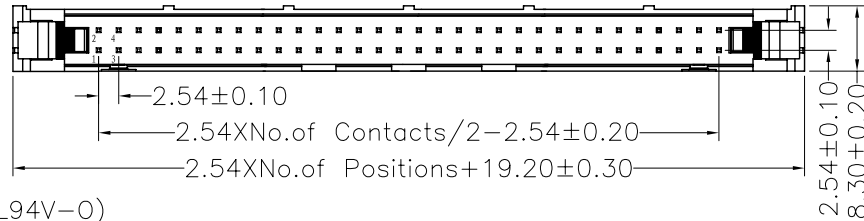

Recommended P.C.B Layout(Top Side)
 (PCB BOARD TOLERANCE±0.05)

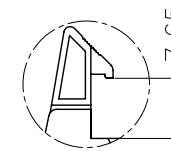
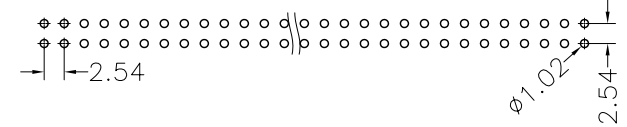

Long Latch

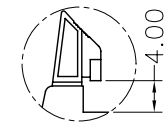

Short Latch

Ordering Information

MTE10- XX S X

No.of Pins	Latch Type
06 24	L=Long Latch
08 26	S=Short Latch
10 30	N=Without Latch
12 34	
14 40	
16 50	
18 60	
20 64	

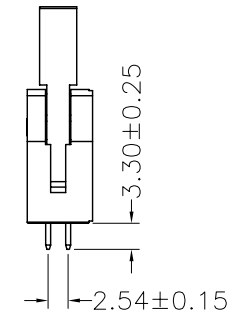
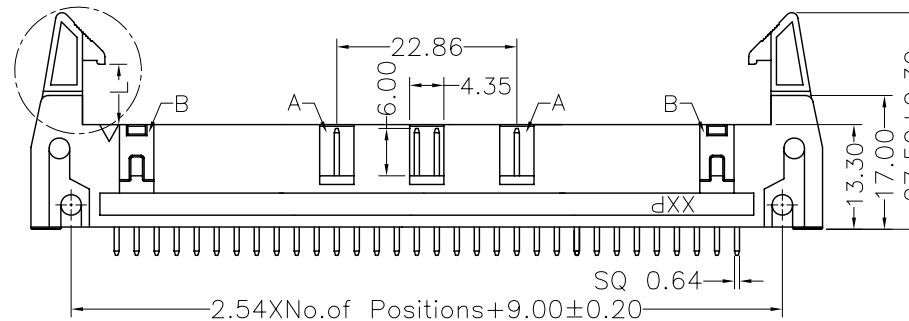

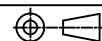
X. ± 0.30	X.° ± 5°	UNITS mm	NAME(INTENDED USE)	MINTRON CO.,LTD.								
.X ± 0.20	.X° ± 2°	MAT'L	PART NO.(INTENDED USE)				TITLE: MTE10-XXSL					
.XX ± 0.10	.XX° ± 1°	FINISH	APPD: SUNNY	DWG NO.:								
.XXX ± 0.05	.XXX° ± 0.5°	Q'TY	CHKD: LISA	 <table border="1"> <tr> <td>SCALE</td> <td>SHEET</td> <td>REV.</td> </tr> <tr> <td>1/1</td> <td>1/1</td> <td>A</td> </tr> </table>			SCALE	SHEET	REV.	1/1	1/1	A
SCALE	SHEET	REV.										
1/1	1/1	A										
EJECTOR HEADER CONNECTOR			DR: ZOE 2006-11-28									

X-ON Electronics

Largest Supplier of Electrical and Electronic Components

Click to view similar products for [Headers & Wire Housings](#) category:

Click to view products by [MINTRON](#) manufacturer:

Other Similar products are found below :

[57102-F02-18ULF](#) [58102-G61-06LF](#) [0009485154](#) [009176003701906](#) [0050291907](#) [02.125.8002.8](#) [609-3404](#) [61062-3](#) [622-0430](#) [622-3653LF](#)
[63453-116](#) [636-1030](#) [636-1427](#) [636-3427](#) [636-4007](#) [641938-9](#) [644827-2](#) [65495-038](#) [65692-001LF](#) [65781-018](#) [65781-047](#) [65817-010LF](#)
[65817-015LF](#) [66207-023LF](#) [67016-026LF](#) [67095-007LF](#) [68631-112](#) [68645-018](#) [68648-049](#) [699319-000](#) [70.362.1628.0](#) [70-4210](#) [70-4226B](#)
[70-4853B](#) [707-5020](#) [707-5028](#) [71.350.2428.0](#) [71961-016LF](#) [733-134](#) [754199-000](#) [760-3052](#) [787-8014-00](#) [FCN-367T-T012/H](#) [80.063.4001.1](#)
[800-90-001-10-001000](#) [800-90-010-10-002000](#) [801-43-002-10-013000](#) [801-43-006-10-002000](#) [803-41-018-10-001000](#) [803-43-014-20-001000](#)