

技术指标:

1. 塑件表面应光洁、无毛边、无明显收缩、缺陷、裂纹等现象。
2. 温度范围: -25°C~85°C。
3. 额定电压: 50V, AC/DC(等效)。
4. 接触电阻:  $\leq 0.03\Omega$ 。
5. 绝缘电阻:  $\geq 500M\Omega$ 。
6. 产品料号:

NO OF CKT (产品PIN数)  
 XW05200-\*\*\*  
 0: 端子全雾锡  
 1: 端子全金(G/F OVERALL)  
 2: 端子半金锡  
 R: TAPE & REEL 卷装  
 T: TUBE管装  
 Packing (包装方式)

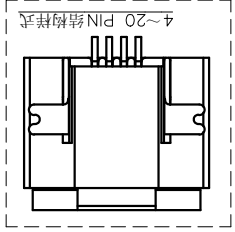
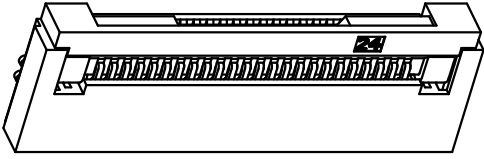
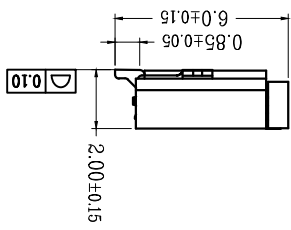
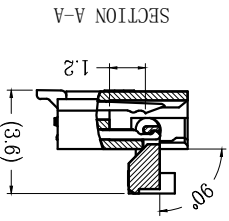
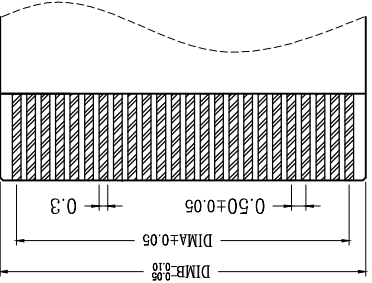
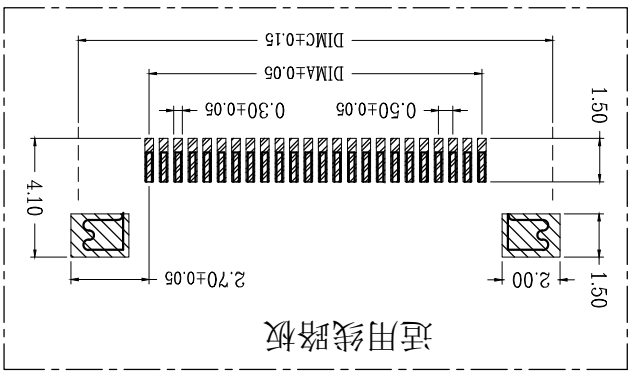
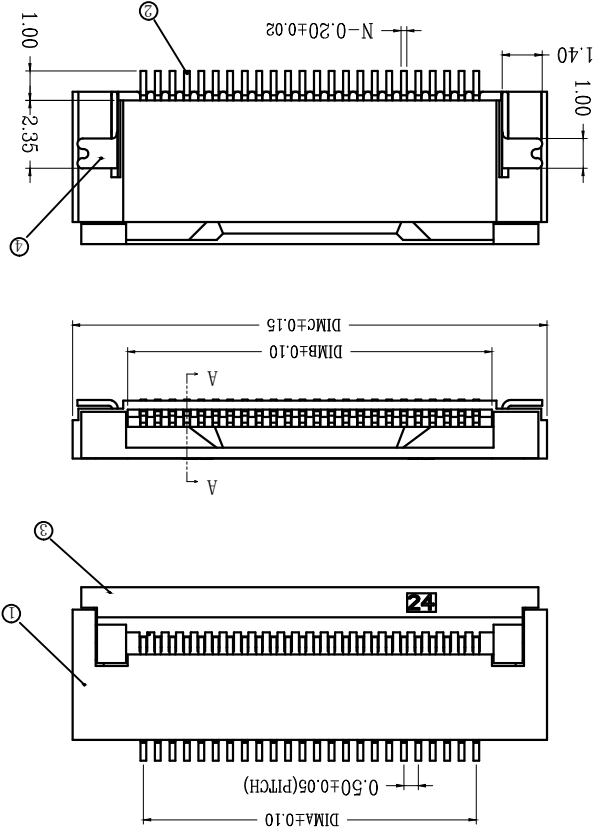

比例 (SCALE)	1:1	单位 (UNITS)	mm
料号 (DWG.NO)	XW05200-***		
校对 (CHKD)	SUNNY		
制图 (DR)	TONY		
品名 (TITLE)	MINTRON TECHNOLOGY CO., LTD.		
0.5 Pitch 掀盖卧式下接(H=2.0)			
张数 (SHEET)	1 OF 1	尺寸 (SIZE)	A4
审核 (APP)	JTM		

32	15.50	16.60	20.40	32	15.50	16.60	20.40
31	15.00	16.10	19.90	31	15.00	16.10	19.90
30	14.50	15.60	19.40	30	14.50	15.60	19.40
29	14.00	15.10	18.90	29	14.00	15.10	18.90
28	13.50	14.60	18.40	28	13.50	14.60	18.40
27	13.00	14.10	17.90	27	13.00	14.10	17.90
26	12.50	13.60	17.40	26	12.50	13.60	17.40
25	12.00	13.10	16.90	25	12.00	13.10	16.90
24	11.50	12.60	16.40	24	11.50	12.60	16.40
23	11.00	12.10	15.90	23	11.00	12.10	15.90
22	10.50	11.60	15.40	22	10.50	11.60	15.40
21	10.00	11.10	14.90	21	10.00	11.10	14.90
20	9.50	10.60	14.40	20	9.50	10.60	14.40
19	9.00	10.10	13.90	19	9.00	10.10	13.90
18	8.50	9.60	13.40	18	8.50	9.60	13.40
17	8.00	9.10	12.90	17	8.00	9.10	12.90
16	7.50	8.60	12.40	16	7.50	8.60	12.40
15	7.00	8.10	11.90	15	7.00	8.10	11.90
14	6.50	7.60	11.40	14	6.50	7.60	11.40
13	6.00	7.10	10.90	13	6.00	7.10	10.90
12	5.50	6.60	10.40	12	5.50	6.60	10.40
11	5.00	6.10	9.90	11	5.00	6.10	9.90
10	4.50	5.60	9.40	10	4.50	5.60	9.40
9	4.00	5.10	8.90	9	4.00	5.10	8.90
8	3.50	4.60	8.40	8	3.50	4.60	8.40
7	3.00	4.10	7.90	7	3.00	4.10	7.90
6	2.50	3.60	7.40	6	2.50	3.60	7.40
5	2.00	3.10	6.90	5	2.00	3.10	6.90
4	1.50	2.60	6.40	4	1.50	2.60	6.40
CKT DIMA DIMB	CKT DIMA DIMB	CKT DIMA DIMB	CKT DIMA DIMB	CKT DIMA DIMB	CKT DIMA DIMB	CKT DIMA DIMB	CKT DIMA DIMB
33	16.00	17.10	20.90	33	16.00	17.10	20.90
34	16.50	17.60	21.40	34	16.50	17.60	21.40
35	17.00	18.10	21.90	35	17.00	18.10	21.90
36	17.50	18.60	22.40	36	17.50	18.60	22.40
37	18.00	19.10	22.90	37	18.00	19.10	22.90
38	18.50	19.60	23.40	38	18.50	19.60	23.40
39	19.00	20.10	23.90	39	19.00	20.10	23.90
40	19.50	20.60	24.40	40	19.50	20.60	24.40
41	20.00	21.10	24.90	41	20.00	21.10	24.90
42	20.50	21.60	25.40	42	20.50	21.60	25.40
43	21.00	22.10	25.90	43	21.00	22.10	25.90
44	21.50	22.60	26.40	44	21.50	22.60	26.40
45	22.00	23.10	26.90	45	22.00	23.10	26.90
46	22.50	23.60	27.40	46	22.50	23.60	27.40
47	23.00	24.10	27.90	47	23.00	24.10	27.90
48	23.50	24.60	28.40	48	23.50	24.60	28.40
49	24.00	25.10	28.90	49	24.00	25.10	28.90
50	24.50	25.60	29.40	50	24.50	25.60	29.40
51	25.00	26.10	29.90	51	25.00	26.10	29.90
52	25.50	26.60	30.40	52	25.50	26.60	30.40
53	26.00	27.10	30.90	53	26.00	27.10	30.90
54	26.50	27.60	31.40	54	26.50	27.60	31.40
55	27.00	28.10	31.90	55	27.00	28.10	31.90
56	27.50	28.60	32.40	56	27.50	28.60	32.40
57	28.00	29.10	32.90	57	28.00	29.10	32.90
58	28.50	29.60	33.40	58	28.50	29.60	33.40
59	29.00	30.10	33.90	59	29.00	30.10	33.90
60	29.50	30.60	34.40	60	29.50	30.60	34.40

1	0.5掀盖胶芯	LCP UL94V-0 本色	材质
2	0.5掀盖端子	磷青铜/表面镀锡	
3	0.5掀盖后盖	LCP UL94V-0 黑色	
4	0.5掀盖焊片	黄铜/表面镀锡	

1	变更摘要	增加料号说明	2015/1/28
---	------	--------	-----------

## X-ON Electronics

Largest Supplier of Electrical and Electronic Components

*Click to view similar products for [FFC & FPC Connectors](#) category:*

*Click to view products by [MINTRON](#) manufacturer:*

Other Similar products are found below :

[HFW11R-1STE1H1LF](#) [FH29B-100S-0.2SHW\(99\)](#) [FA5S008HP1](#) [FH29B-120S-0.2SHW\(99\)](#) [FH29B-80S-0.2SHW\(99\)](#) [FHS-16](#) [FPH-2022G](#)  
[52610-1075](#) [52610-1275](#) [52610-1934](#) [XF3M\(1\)-1415-1B-R100](#) [501864-3091-TR225](#) [0525594033](#) [086210010340800](#) [086222026001800](#)  
[52271-2869-CUT-TAPE](#) [62674-201121DLF](#) [62684-36210E9ALF](#) [52610-1675](#) [52746-1671-TR250](#) [10051922-2810EHLF](#) [6-520415-9](#)  
[BD021-09A-A1-0350-0200-0550-LD](#) [SFV6R-1STE9HLF](#) [XF3M-2915-1B-R100](#) [1658549-1](#) [62674-221121ALF](#) [46214008010800](#)  
[046298003000883](#) [151660622](#) [842-816-2630-035](#) [AYF530665TA](#) [AYF351525](#) [046296011930846+](#) [AYF352325A](#) [046254020000800+](#)  
[FH19C-13S-0.5SH\(99\)](#) [FH39J-51S-0.3SHW\(99\)](#) [AYF355125A](#) [AYF530365TA](#) [FH29B-44S-0.2SHW\(99\)](#) [SFW5R-2STAE9LF](#) [AYF351125A](#)  
[AYF350725A](#) [62684-502100AHLF](#) [FH39-61S-0.3SHW\(99\)](#) [AYF414035A](#) [10064555-172520HLF](#) [AYF212335A](#) [504754-2500](#)