

RODZAJ POLACZENIA/INTERNAL CIRCUIT
 PATRZ SCHEMATY POLACZEN/WIRING CONFIGURATION
 NAPIECIE ORAZ KOLOR DIODY/VOLTAGE AND LED COLOUR:

1= 12V	A= 12V	G= 12V	ZOLTA DIODA YELLOW LED
2= 24V	B= 24V	H= 24V	
3= 48V	C= 48V	K= 48V	
4= 115V	D= 115V	L= 115V	
5= 230V	E= 230V	M= 230V	

MOLEX PN	MPM PN	MOLEX PN	MPM PN
1210010189	A06A11	1210010216	A06C4D
1210010190	A06A12	1210010217	A06C4E
1210010192	A06A14	1210010219	A06C4H
1210010193	A06A15	1210010220	A06C4L
1210010194	A06A1B	1210010221	A06C4M
1210010197	A06A1H	1210010222	A06G21
1210010199	A06A1L	1210010223	A06G22
1210010200	A06A1M	1210010225	A06G24
1210010202	A06C32	1210010226	A06G25
1210010205	A06C35	1210010228	A06G2B
1210010206	A06C3B	1210010229	A06G2D
1210010207	A06C3H	1210010230	A06G2E
1210010209	A06C41	1210010231	A06G2H
1210010210	A06C42	1210010232	A06G2K
1210010211	A06C43	1210010233	A06G2L
1210010212	A06C44	1210010234	A06G2M
1210010213	A06C45	1210010236	A06S02
1210010420	A06C4A	1210010240	A06S0H
1210010214	A06C4B	1210010198	A06A1K
1210010215	A06C4C	1210010241	A06S0L

SCHEMATY POLACZEN
 /WIRING CONFIGURATION

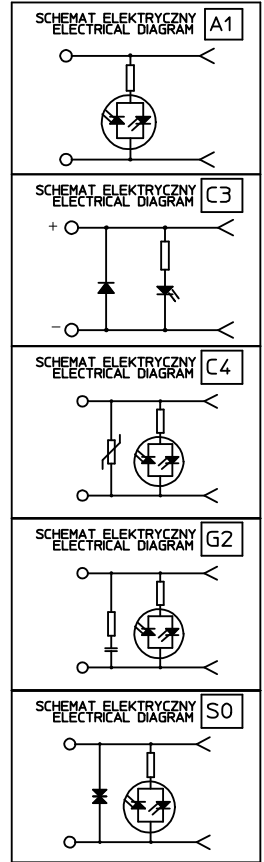

TAMPONADRUK SCHEMATU (BIALY)
 CIRCUIT PRINTOUT (WHITE)

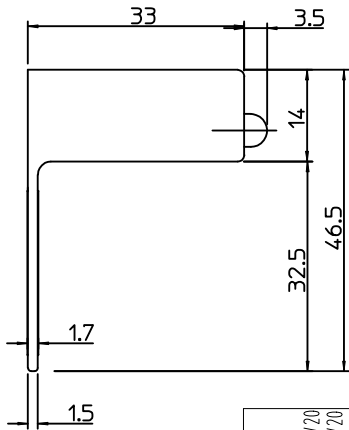
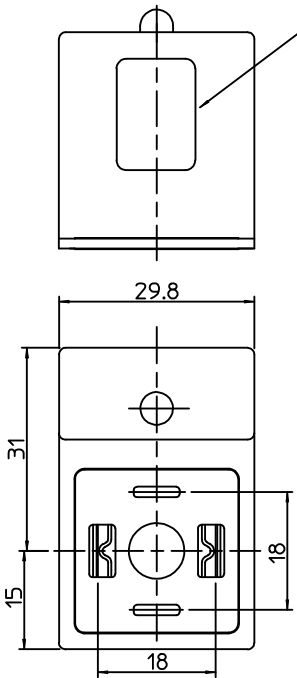

ORIGINAL RELEASE EC NO: WEUS2009-0479 DRWIN: MWOLSZCZAK 2009/05/20 CHYKD: MDABROWSKA 2009/05/20 APPR: GOGRODNIK 2009/05/20	QUALITY SYMBOLS	GENERAL TOLERANCES (UNLESS SPECIFIED)	DIMENSION STYLE	SCALE	DESIGN UNITS	FIRST ANGLE PROJECTION
		mm INCH	MM ONLY	---	METRIC	
	4 PLACES	± --- ± ---	DRAWN BY DATE	TITLE		
	3 PLACES	± --- ± ---	MLEVYTSKYY 2009/05/05	MPM A06 ADAPTORS		
	2 PLACES	± --- ± ---	CHECKED BY DATE	MATERIAL NO.		
1 PLACE	± --- ± ---	MDABROWSKA 2009/05/05	DOCUMENT NO.			
	ANGULAR ± --- °	APPROVED BY DATE	SHEET NO.			
		MWOLSZCZAK 2009/05/05	1 OF 1			
			MOLEX INCORPORATED			
			A06XXX			
			THIS DRAWING CONTAINS INFORMATION THAT IS PROPRIETARY TO MOLEX INCORPORATED AND SHOULD NOT BE USED WITHOUT WRITTEN PERMISSION			

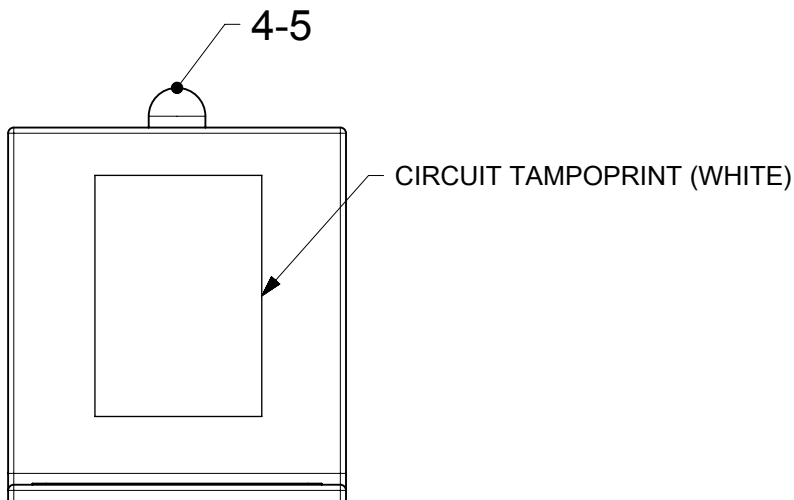
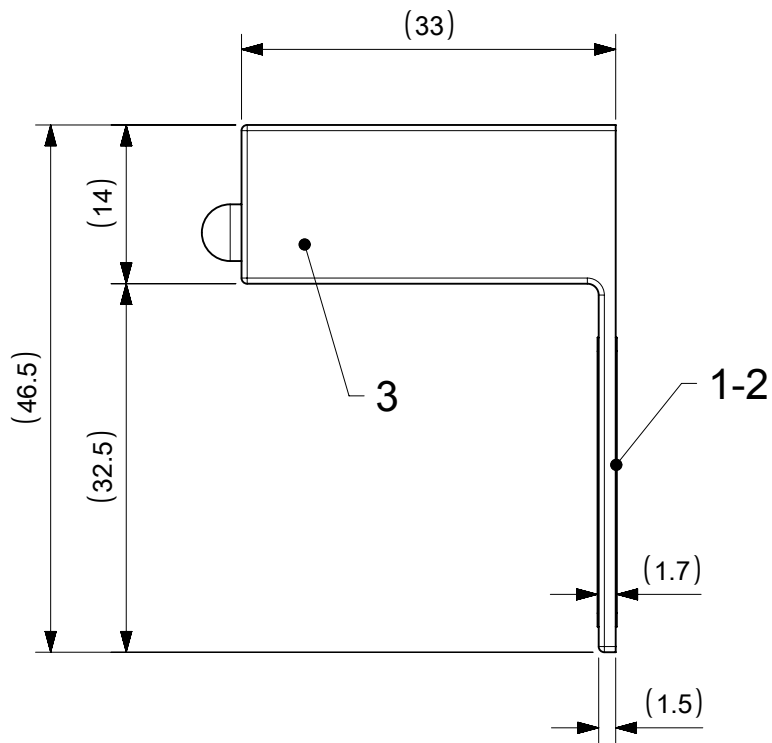
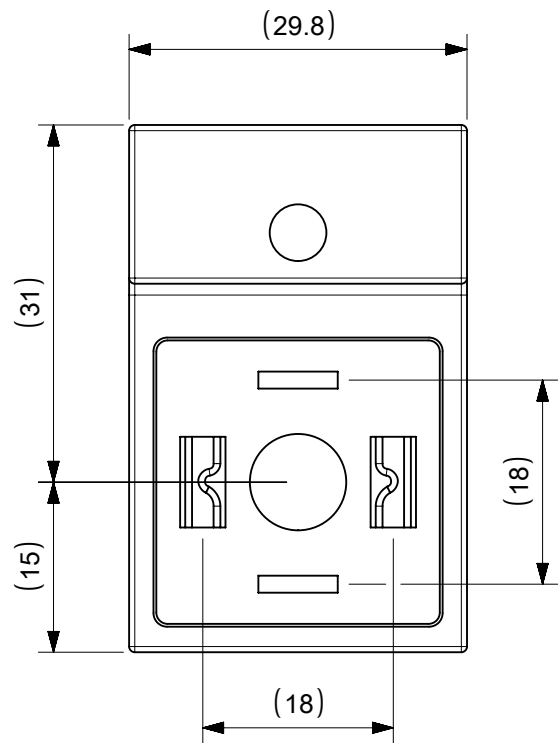

SCHMATY POŁĄCZEŃ/ WIRING CONFIGURATION

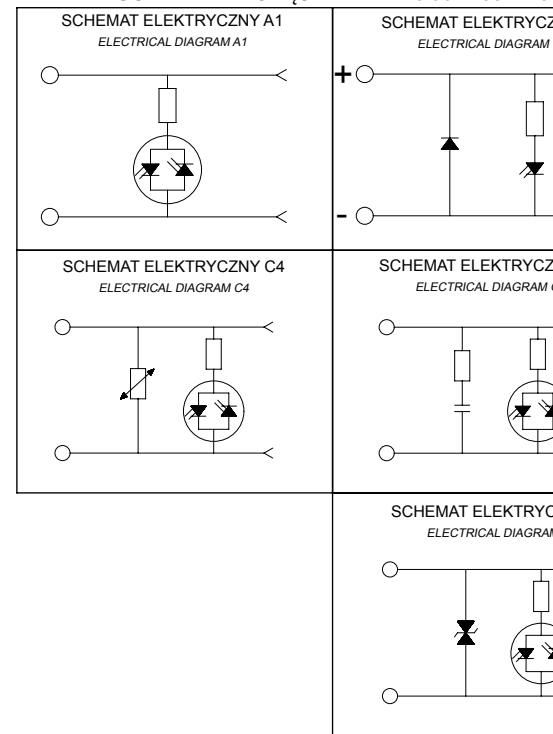

SYMBOLS	THIS DRAWING CONTAINS INFORMATION THAT IS PROPRIETARY TO MOLEX ELECTRONIC TECHNOLOGIES, LLC AND SHOULD NOT BE USED WITHOUT WRITTEN PERMISSION		CURRENT REV DESC:			
	DIMENSION UNITS	SCALE				
▽ = 0	mm	1:1	GENERAL TOLERANCES (UNLESS SPECIFIED)		LIGHTS ADAPTORS SERIES A06XXX FOR DIN A	
▽ = 0						
▽ = 0	ANGULAR TOL ± °		INITIAL REVISION:		PRODUCT CUSTOMER DRAWING DOCUMENT NUMBER: SD-121001-006 DOC TYPE: PSD DOC NO: 00	
▽ = 0	4 PLACES ±					
▽ = 0	3 PLACES ±		DRWN: JMARSZALEK 2013/02/11 APPR: MIWASIECZKO 2013/02/12		MATERIAL NUMBER: SEE SHEET 2 CUSTOMER: GENERAL MARKET	
▽ = 0	2 PLACES ±					
▽ = 0	1 PLACE ±		DRAFT WHERE APPLICABLE MUST REMAIN WITHIN DIMENSIONS		THIRD ANGLE PROJECTION 	
▽ = 0	0 PLACES ±					
▽ = 0	DRAFT WHERE APPLICABLE MUST REMAIN WITHIN DIMENSIONS		DRAWING: A4-SIZE		SERIES: 121001	

DOCUMENT STATUS	P1	RELEASE DATE	2018/11/15	10:10:34
-----------------	----	--------------	------------	----------

6

5

4

3

2

1

PART LIST

MOLEX PN	ENG. NO	CIRCUIT TYPE	LED COLOR
1210010189	A06A11	A1 12V	RED
1210010190	A06A12	A1 24V	RED
1210010191	A06A13	A1 48V	RED
1210010192	A06A14	A1 115V	RED
1210010193	A06A15	A1 230V	RED
1210010194	A06A1B	A1 24V	GREEN
1210010197	A06A1H	A1 24V	YELLOW
1210010198	A06A1K	A1 48V	YELLOW
1210010199	A06A1L	A1 115V	YELLOW
1210010200	A06A1M	A1 230V	YELLOW
1210010202	A06C32	C3 24V	RED
1210010205	A06C35	C3 230V	RED
1210010206	A06C3B	C3 24V	GREEN
1210010207	A06C3H	C3 24V	YELLOW
1210010209	A06C41	C4 12V	RED
1210010210	A06C42	C4 24V	RED
1210010211	A06C43	C4 48V	RED
1210010212	A06C44	C4 115V	RED
1210010213	A06C45	C4 230V	RED
1210010214	A06C4B	C4 24V	GREEN
1210010215	A06C4C	C4 48V	GREEN
1210010216	A06C4D	C4 115V	GREEN
1210010217	A06C4E	C4 230V	GREEN
1210010218	A06C4G	C4 12V	YELLOW
1210010219	A06C4H	C4 24V	YELLOW
1210010220	A06C4L	C4 115V	YELLOW
1210010221	A06C4M	C4 230V	YELLOW
1210010222	A06G21	G2 12V	RED
1210010223	A06G22	G2 24V	RED
1210010224	A06G23	G2 48V	RED
1210010225	A06G24	G2 115V	RED
1210010226	A06G25	G2 230V	RED
1210010228	A06G2B	G2 24V	GREEN
1210010229	A06G2D	G2 115V	GREEN
1210010230	A06G2E	G2 230V	GREEN
1210010231	A06G2H	G2 24V	YELLOW
1210010232	A06G2K	G2 48V	YELLOW
1210010233	A06G2L	G2 115V	YELLOW
1210010234	A06G2M	G2 230V	YELLOW
1210010236	A06S02	S0 24V	RED
1210010240	A06S0H	S0 24V	YELLOW
1210010241	A06S0L	S0 115V	YELLOW
1210010420	A06C4A	C4 12V	GREEN
1210010437	A06A1E	A1 230V	GREEN
1210010447	A06A1D	A1 115V	GREEN
1210010500	A06S0K	S0 48V	YELLOW

PART No MATRIX











INTERNAL CIRCUIT

VOLTAGE AND LED COLOR

1= 12V	RED LED	A= 12V	GREEN LED	G= 12V	YELLOW
2= 24V		B= 24V		H= 24V	
3= 48V		C= 48V		K= 48V	
4= 115V		D= 115V		L= 115V	
5= 230V		E= 230V		M= 230V	

ITEM	QTY	DESCRIPTION	MATERIAL	FINISH/
5	1	DISTANZIALE LED	-	-
4	1	PCB WITH COMPONENT	-	SEE PA
3	1	CORPO STAMPATO	-	BLACK
2	-	EPOXY ER2188K5K	-	BLACK
1	-	EPOXY ER2188B	-	BLACK

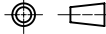
SYMBOLS	THIS DRAWING CONTAINS INFORMATION THAT IS PROPRIETARY TO MOLEX ELECTRONIC TECHNOLOGIES, LLC AND SHOULD NOT BE USED WITHOUT WRITTEN PERMISSION.		CURRENT REV DESC:		 LIGHTS ADAPTORS SERIES A06XXX FOR DIN A		
	DIMENSION UNITS	SCALE					
 = 0	mm	1:1			PRODUCT CUSTOMER DRAWING DOCUMENT NUMBER: SD-121001-006 DOC TYPE: PSD 00 MATERIAL NUMBER: SEE SHEET 2 CUSTOMER: GENERAL MARKET		
 = 0	GENERAL TOLERANCES (UNLESS SPECIFIED)		EC NO: 607661				
 = 0	ANGULAR TOL ± °		DRWN: MCELEJEWSKI 2018/11/14				
 = 0	4 PLACES	±	CHK'D: DSTACHOWIAK 2018/11/15				
 = 0	3 PLACES	±	APPR: DSTACHOWIAK 2018/11/15				
 = 0	2 PLACES	±	INITIAL REVISION:				
 = 0	1 PLACE	±	DRWN: JMARSZALEK 2013/02/11				
 = 0	0 PLACES	±	APPR: MIWASIECZKO 2013/02/12				
= 0	DRAFT WHERE APPLICABLE MUST REMAIN WITHIN DIMENSIONS		THIRD ANGLE PROJECTION	DRAWING			SERIES
= 0				A4-SIZE			121001

DOCUMENT STATUS	P1	RELEASE DATE	2018/11/15	10:10:34
-----------------	----	--------------	------------	----------

6

5

4

3

2

1

X-ON Electronics

Largest Supplier of Electrical and Electronic Components

Click to view similar products for [Circular DIN Connectors](#) category:

Click to view products by [Molex](#) manufacturer:

Other Similar products are found below :

[60KD4M](#) [CTVP00RW-19-32S\(506\)](#) [M83723/76W22326](#) [M83723/78R22327](#) [D38999/26FE99SN L/C](#) [75-069228-21J](#) [7547401103P](#) [75-474014-07L](#) [88-559975-75P](#) [8R3006A18M0033](#) [PT02E1283P](#) [GTC00G-24-7S](#) [PT05A-14-5SX](#) [PT05A1832SW](#) [PT05E2255PW](#) [PT05SE1832SWLC](#) [PT05SE1832SYLC](#) [GTC030-20-27PW-LC](#) [GTC030A-20-33S](#) [PT06SE1811SXLC](#) [1211290078](#) [1211810025](#) [1210120122](#) [ACC06AF-20-23P\(003\)](#) [1210503216](#) [1211290084](#) [1211500027](#) [ACS06AF-16-10P\(003\)](#) [D38999/40FB35AN](#) [D38999/40FB35BB](#) [D38999/40WB35BN](#) [D38999/40WD35PN](#) [D38999/40WJ29SN-L/C](#) [D38999/40WJ4BN](#) [D38999/42FB35BN](#) [D38999/42WB35AB](#) [D38999/42WB35PB-L/C](#) [D38999/42WJ19AN](#) [D38999/42WJ24PN-L/C](#) [D38999/44WB35AN](#) [D38999/44WD35BN](#) [D38999/44WH21AN](#) [D38999/44WH35AN](#) [D38999/44WJ29BA](#) [D38999/44WJ35PN](#) [D38999/44WJ61BA](#) [D38999/46FB35AC](#) [D38999/46FB35BN](#) [D38999/46FB35SA-L/C](#) [D38999/46FB99BA](#)