

ITEM	DESCRIPTION
1	SCREW
2	COVER ASSEMBLY
3	INSERT ASSEMBLY
4	GASKET

C18209N21**

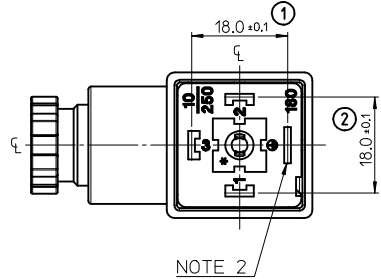
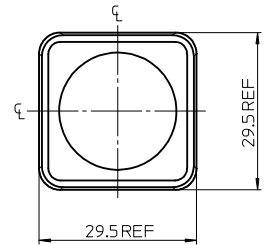
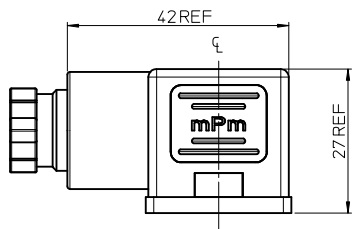
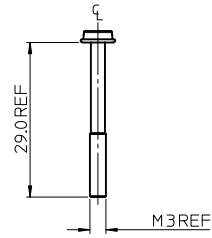

SERIES _____
 C18= INTERNAL THREAD FORM A
 POLES _____
 2= 2 POLE & 3= 3 POLE
 THREAD SIZE _____
 09= PG9, 11= PG11, M6= M16x1.5, M0= M20x1.5, 12= 1/2" GAS, 13= 1/2" NPTF
 39= PG9 W/STRAIN RELIEF, 41= PG11 W/STRAIN RELIEF
 MATERIAL AND HOUSING COLOUR _____
 G = PA6 GRAY, H= PA6 HEAT PROTECTION,
 N= PA6 BLACK, W= PA66 BLACK V0, T= TRANSPARENT
 GROUND POSITION _____
 0= UNMOUNTED, 2= H12, 3= H3, 6= H6 & 9= H9

SCREW AND GASKET _____
 1= NBR PROFILE GASKET & SCREW
 2= NBR FLAT GASKET & SCREW
 3= WHITE SILICONE PROFILE GASKET & SCREW
 4= WHITE SILICONE FLAT GASKET & SCREW
 5= NBR PROFILE GASKET, NO SCREW
 9= NO GASKET, NO SCREW
 0= NO GASKET, NO SCREW
 A= NBR PROFILE GASKET & SCREW +2mm
 B= NBR FLAT GASKET & SCREW +2mm
 C= WHITE SILICONE PROFILE GASKET & SCREW +2mm
 G= NO GASKET & STANDARD SCREW
 I= BULK PACK FULLY MOUNTED, NO GASKET
 P= INTEGRATED NBR GASKET & IP67 SCREW ASSEMBLED
 R= INTEGRATED NBR GASKET & IP67 SCREW NOT ASSEMBLED

NON STANDARD COMPONENTS
 14= SINGLE BAG
 19= PIN NO.3 NON CONNECTED/REMOVED,
 23= ASSEMBLED SCREWS & GASKET
 10= SPECIAL GROMMET
 4S= SPECIAL GROMMET
 5A= SINGLE BAGGED 500 IN A BOX
 9V= NO SCREW OR GASKET
 AF= CENTRE SCREW MOUNTED
 BM= GOLD TERMINALS
 BS= FULLY UNMOUNTED ALL COMPONENTS IN SEPARATE BAGS
 OH= INOX SCREW
 P7= IP67 COMPLIANT
 SA= UL LISTED PART

NOTES
 1. PLEASE SEE SHEET 2 FOR CURRENTLY CONFIGURED PART NUMBERS, FOR SPECIFIC PART NUMBERS PLEASE CONTACT SALES OR CONSULT THE INTELLIGENT PART NUMBERS IN THE TABLE ATTACHED
 2. EARTH POSITION SHOWN, H12.
 3. FOR PACKAGING SEE PACKAGING SPEC PK-121023-C18
 4. PRODUCT SPEC: SEE PS-121201-001
 LAST INSPECTION NUMBER 2

ADDED P/N EC NO: IFC2016-0551 DRWN: JBRYNES 2015/10/09 CHKD: DSHEA 2015/10/12 APPR: STGERLEIN 2015/11/25	QUALITY SYMBOLS ▽=0 ▽=0	GENERAL TOLERANCES (UNLESS SPECIFIED) <table border="1"> <thead> <tr> <th></th> <th>mm</th> <th>INCH</th> </tr> </thead> <tbody> <tr> <td>4 PLACES</td> <td>±---</td> <td>±---</td> </tr> <tr> <td>3 PLACES</td> <td>±---</td> <td>±---</td> </tr> <tr> <td>2 PLACES</td> <td>±0.1</td> <td>±---</td> </tr> <tr> <td>1 PLACE</td> <td>±0.2</td> <td>±---</td> </tr> <tr> <td colspan="3">ANGULAR ±---°</td> </tr> </tbody> </table>		mm	INCH	4 PLACES	±---	±---	3 PLACES	±---	±---	2 PLACES	±0.1	±---	1 PLACE	±0.2	±---	ANGULAR ±---°			DIMENSION STYLE MM ONLY	SCALE 1.5:1	DESIGN UNITS METRIC	THIRD ANGLE PROJECTION
		mm	INCH																					
4 PLACES	±---	±---																						
3 PLACES	±---	±---																						
2 PLACES	±0.1	±---																						
1 PLACE	±0.2	±---																						
ANGULAR ±---°																								
DRAWN BY JOCONNOR 2011/05/04 CHECKED BY DMAHER 2011/05/06 APPROVED BY EFOLAN 2011/05/24	TITLE C18 SERIES INTERNAL THREAD		MOLEX INCORPORATED																					
MATERIAL NO. SEE SHEET 2	DRAFT WHERE APPLICABLE MUST REMAIN WITHIN DIMENSIONS		DOCUMENT NO. SD-121023-001		SHEET NO. 1 OF 2																			
THIS DRAWING CONTAINS INFORMATION THAT IS PROPRIETARY TO MOLEX INCORPORATED AND SHOULD NOT BE USED WITHOUT WRITTEN PERMISSION																								

PART No.	mPm PART No.	DESCRIPTION
1210230229	C18209G21	TYPE A 2P PG9 GRAY, NBR PROFILE GASKET & SCREW
1210230231	C18209G22	TYPE A 2P PG9 GRAY, NBR FLAT GASKET & SCREW
1210230233	C18209G31	TYPE A 2P PG9 GRAY, NBR PROFILE GASKET & SCREW
-	-	-
1210230238	C18209N21	TYPE A 2P PG9 BLACK, NBR PROFILE GASKET & SCREW
1210230242	C18209N22	TYPE A 2P PG9 BLACK, NBR FLAT GASKET & SCREW
1210230244	C18209N23	TYPE A 2P PG9 BLACK, WHITE SILICONE PROFILE GASKET & SCREW
1210230245	C18209N24	TYPE A 2P PG9 BLACK, WHITE SILICONE FLAT GASKET & SCREW
1210230246	C18209N25	TYPE A 2P PG9 BLACK, NBR PROFILE GASKET, NO SCREW
1210230249	C18209N2A	TYPE A 2P PG9 BLACK, NBR PROFILE GASKET & SCREW +2mm
1210230251	C18209N31	TYPE A 2P PG9 BLACK, NBR PROFILE GASKET & SCREW
1210230252	C18209N61	TYPE A 2P PG9 BLACK, NBR PROFILE GASKET & SCREW
1210230253	C18209N62	TYPE A 2P PG9 BLACK, NBR FLAT GASKET & SCREW
1210230254	C18209T21	TYPE A 2P PG9 TRANSPARENT, NBR PROFILE GASKET & SCREW
1210230271	C18211G21	TYPE A 2P PG11 GRAY, NBR PROFILE GASKET & SCREW
1210230278	C18211N21	TYPE A 2P PG11 BLACK, NBR PROFILE GASKET & SCREW
1210230282	C18211N23	TYPE A 2P PG11 BLACK, WHITE SILICONE PROFILE GASKET & SCREW
1210230283	C18211N24	TYPE A 2P PG11 BLACK, WHITE SILICONE FLAT GASKET & SCREW
1210230284	C18211N61	TYPE A 2P PG11 BLACK, NBR PROFILE GASKET & SCREW
1210230286	C18211T21	TYPE A 2P PG11 TRANSPARENT, NBR PROFILE GASKET & SCREW
1210230291	C18211W21	TYPE A 2P PG11 BLACK V0, NBR PROFILE GASKET & SCREW
1210230305	C18212N21	TYPE A 2P 1/2" GAS BLACK, NBR PROFILE GASKET & SCREW
1210230315	C18213G21	TYPE A 2P 1/2" NPTF GRAY, NBR PROFILE GASKET & SCREW
1210230319	C18213N21	TYPE A 2P 1/2" NPTF BLACK, NBR PROFILE GASKET & SCREW
1210230328	C18239G21	TYPE A 2P PG9 W/STRAIN RELIEF GRAY, NBR PROFILE GASKET & SCREW
1210230331	C18241N21	TYPE A 2P PG11 W/STRAIN RELIEF BLACK, NBR PROFILE GASKET & SCREW
1210230336	C18309G21	TYPE A 3P PG9 GRAY, NBR PROFILE GASKET & SCREW
1210230337	C18309G22	TYPE A 3P PG9 GRAY, NBR FLAT GASKET & SCREW
1210230341	C18309N21	TYPE A 3P PG9 BLACK, NBR PROFILE GASKET & SCREW
1210230345	C18309N23	TYPE A 3P PG9 BLACK, WHITE SILICONE PROFILE GASKET & SCREW
1210230346	C18309N24	TYPE A 3P PG9 BLACK, WHITE SILICONE FLAT GASKET & SCREW
1210230352	C18309N2G	TYPE A 3P PG9 BLACK, NO GASKET, & STANDARD SCREW
1210230354	C18309N61	TYPE A 3P PG9 BLACK, NBR PROFILE GASKET & SCREW
1210230356	C18309N64	TYPE A 3P PG9 BLACK, WHITE SILICONE FLAT GASKET & SCREW
1210230358	C18309T21	TYPE A 3P PG9 TRANSPARENT, NBR PROFILE GASKET & SCREW
1210230364	C18309W21	TYPE A 3P PG9 BLACK V0, NBR PROFILE GASKET & SCREW
1210230367	C18309W23	TYPE A 3P PG9 BLACK V0, WHITE SILICONE PROFILE GASKET & SCREW
1210230372	C18311G21	TYPE A 3P PG11 GRAY, NBR PROFILE GASKET & SCREW
1210230373	C18311G22	TYPE A 3P PG11 GRAY, NBR FLAT GASKET & SCREW
1210230374	C18311G61	TYPE A 3P PG11 GRAY, NBR PROFILE GASKET & SCREW
1210230377	C18311N21	TYPE A 3P PG11 BLACK, NBR PROFILE GASKET & SCREW
1210230378	C18311N22	TYPE A 3P PG11 BLACK, NBR FLAT GASKET & SCREW
1210230379	C18311N31	TYPE A 3P PG11 BLACK, NBR PROFILE GASKET & SCREW
1210230382	C18311N61	TYPE A 3P PG11 BLACK, NBR PROFILE GASKET & SCREW
1210230384	C18311T21	TYPE A 3P PG11 TRANSPARENT, NBR PROFILE GASKET & SCREW
1210230388	C18311W21	TYPE A 3P PG11 BLACK V0, NBR PROFILE GASKET & SCREW
1210230400	C18312N21	TYPE A 3P 1/2" GAS BLACK, NBR PROFILE GASKET & SCREW
1210230401	C18312N22	TYPE A 3P 1/2" GAS BLACK, NBR FLAT GASKET & SCREW
1210230410	C18313G21	TYPE A 3P 1/2" NPTF GRAY, NBR PROFILE GASKET & SCREW
1210230414	C18313N21	TYPE A 3P 1/2" NPTF BLACK, NBR PROFILE GASKET & SCREW
1210230415	C18313N22	TYPE A 3P 1/2" NPTF BLACK, NBR FLAT GASKET & SCREW
1210230421	C18339N23	TYPE A 3P PG9 W/STRAIN RELIEF BLACK, WHITE SILICONE PROFILE GASKET & SCREW
1210230422	C18339N2C	TYPE A 3P PG9 W/STRAIN RELIEF BLACK, WHITE SILICONE PROFILE GASKET, & SCREW +2mm
1210230645	C183M6N21	TYPE A 3P M16x15 BLACK, NBR PROFILE GASKET & SCREW
1210230656	C183M6G21	TYPE A 3P M16x15 GRAY, NBR PROFILE GASKET & SCREW
1210230660	C183M0N21	TYPE A 3P M20x15 BLACK, NBR PROFILE GASKET & SCREW
1210230662	C182M0N21	TYPE A 2P M20x15 BLACK, NBR PROFILE GASKET & SCREW
1210230677	C182M6N21	TYPE A 2P M16x15 BLACK, NBR PROFILE GASKET & SCREW
1210230704	C182M6N22	TYPE A 2P M16x15 BLACK, NBR FLAT GASKET & SCREW
1210230718	C182M6G21	TYPE A 2P M16x15 GRAY, NBR PROFILE GASKET & SCREW
1210230741	C183M0N22	TYPE A 3P M20x15 BLACK, NO GASKET, & STANDARD SCREW
1210230745	C18209N91	TYPE A 2P PG9 BLACK, NBR PROFILE GASKET & SCREW
1210230763	C18311W2G	TYPE A 3P PG11 BLACK V0, NO GASKET, & STANDARD SCREW
1210230768	C18213T22	TYPE A 2P 1/2" NPTF TRANSPARENT, NBR FLAT GASKET & SCREW
1210230780	C18312N23	TYPE A 3P 1/2" GAS BLACK, WHITE SILICONE PROFILE GASKET & SCREW
1210230793	C18309N2A	TYPE A 3P PG9 BLACK, NBR PROFILE GASKET & SCREW +2mm

PART No.	mPm PART No.	DESCRIPTION
1210230800	C18209G2B	TYPE A 2P PG9 GRAY, NBR FLAT GASKET, & SCREW +2mm
1210230803	C182M0N2A	TYPE A 2P M20x15 BLACK, NBR PROFILE GASKET & SCREW +2mm
1210230804	C18309N33	TYPE A 3P PG9 BLACK, WHITE SILICONE PROFILE GASKET & SCREW
1210230807	C18309N2R	TYPE A 3P PG9 BLACK, INTEGRATED NBR GASKET & IP67 SCREW NOT ASSEMBLED
1210230825	C182M6N2P	TYPE A 2P M16x15 BLACK, INTEGRATED NBR GASKET & IP67 SCREW ASSEMBLED
1210230833	C18211G2A	TYPE A 2P PG11 GRAY, NBR PROFILE GASKET & SCREW +2mm
1210230841	C182M0G21	TYPE A 2P M20x15 GRAY, NBR PROFILE GASKET & SCREW
1210240268	C18311N2G	TYPE A 3P PG11 BLACK, NO GASKET, & STANDARD SCREW
1210240370	C18211N2A	TYPE A 2P PG11 BLACK, NBR PROFILE GASKET & SCREW +2mm
1210240940	C18209N20	TYPE A 2P PG9 BLACK, NO GASKET, NO SCREW
1210240133	C18209N210H	TYPE A 2P PG9 BLACK, NBR PROFILE GASKET, STAINLESS STEEL SCREW
1210240154	C18209N220H	TYPE A 2P PG9 BLACK, NBR FLAT GASKET, STAINLESS STEEL SCREW
1210240378	C18311N210H	TYPE A 3P PG11 BLACK, NBR PROFILE GASKET, STAINLESS STEEL SCREW
1210240139	C18209N2114	TYPE A 2P PG9 BLACK, NBR PROFILE GASKET & SCREW IN NEUTRAL BAG
1210240156	C18209N2214	TYPE A 2P PG9 BLACK, NBR FLAT GASKET & SCREW IN NEUTRAL BAG
1210240224	C18309N2114	TYPE A 3P PG9 BLACK, NBR PROFILE GASKET & SCREW IN NEUTRAL BAG
1210240755	C18309N2R19	TYPE A 3P PG9 BLACK, INTEGRATED NBR GASKET & IP67 SCREW NOT ASSEMBLED W/O PIN No. 3
1210240227	C18309N2110	TYPE A 3P PG9 BLACK, NBR PROFILE GASKET & SCREW, WITH SPECIAL GROMMET
1210240185	C18211G2123	TYPE A 2P PG11 GRAY, NBR PROFILE GASKET & SCREW, FULLY MOUNTED
1210240271	C18311N614S	TYPE A 3P PG11 BLACK, NBR PROFILE GASKET & SCREW, WITH SPECIAL GROMMET
1210240265	C18311N215A	TYPE A 3P PG11 BLACK, NBR PROFILE GASKET & SCREW, SINGLE BAGGED, 500 IN A BOX
1210230350	C18309N299V	TYPE A 3P PG9 BLACK, NO GASKET, NO SCREW
1210240167	C18209N299V	TYPE A 2P PG9 BLACK, NO GASKET, NO SCREW
1210230232	C18209G22AF	TYPE A 2P PG9 GRAY, NBR FLAT GASKET WITH SCREW MOUNTED
1210230243	C18209N22AF	TYPE A 2P PG9 BLACK, NBR FLAT GASKET WITH SCREW MOUNTED
1210230274	C18211G22AF	TYPE A 2P PG11 GRAY, NBR FLAT GASKET WITH SCREW MOUNTED
1210230281	C18211N22AF	TYPE A 2P PG11 BLACK, NBR FLAT GASKET WITH SCREW MOUNTED
1210230648	C18309N31AF	TYPE A 3P PG9 BLACK, NBR PROFILE GASKET WITH SCREW MOUNTED
1210230678	C183M0N31AF	TYPE A 3P M20x15 BLACK, NBR PROFILE GASKET WITH SCREW MOUNTED
1210230696	C183M6N21AF	TYPE A 3P M16x15 BLACK, NBR PROFILE GASKET WITH SCREW MOUNTED
1210230751	C183M6N31AF	TYPE A 3P M16x15 BLACK, NBR PROFILE GASKET WITH SCREW MOUNTED
1210230801	C183M6N22AF	TYPE A 3P M16x15 BLACK, NBR FLAT GASKET WITH SCREW MOUNTED
1210230767	C18311N318M	TYPE A 3P PG11 BLACK, NBR PROFILE GASKET & SCREW, WITH GOLD TERMINALS
1210230728	C18209N21BS	TYPE A 2P PG9 BLACK, NBR PROFILE GASKET & SCREW, FULLY UNMOUNTED
1210230240	C18209N21P7	TYPE A 2P PG9 BLACK, NBR PROFILE GASKET & SCREW, IP67 COMPLIANT
1210230272	C18211G21P7	TYPE A 2P PG11 GRAY, NBR PROFILE GASKET IP67 COMPLIANT
1210230279	C18211N21P7	TYPE A 2P PG11 BLACK, NBR PROFILE GASKET & SCREW, IP67 COMPLIANT
1210230420	C18309N21P7	TYPE A 3P PG9 W/STRAIN RELIEF BLACK, NBR PROFILE GASKET & SCREW, IP67 COMPLIANT
1210230725	C18309N21P7	TYPE A 3P PG9 BLACK, NBR PROFILE GASKET & SCREW, IP67 COMPLIANT
1210230731	C18312N21P7	TYPE A 3P 1/2" GAS BLACK, NBR PROFILE GASKET & SCREW IP67 COMPLIANT
1210230732	C18209G21P7	TYPE A 2P PG9 GRAY, NBR PROFILE GASKET & SCREW IP67 COMPLIANT
1210230843	C183M6N21P7	TYPE A 3P M16x15 BLACK, NBR PROFILE GASKET & SCREW IP67 COMPLIANT
1210230849	C18309N21	TYPE A 3P PG9 BLACK, BULK PACK FULLY MOUNTED, NO GASKET
1210230739	C18311W21SA	TYPE A 3P PG11 BLACK V0, NBR PROFILE GASKET & SCREW, UL LISTED
1210230851	C182M6W21SA	TYPE A 2P M16x15 BLACK V0, NBR PROFILE GASKET UL LISTED
1210230853	C18311N21P7	TYPE A 3P PG11 BLACK, NBR PROFILE GASKET & SCREW, IP67 COMPLIANT
1210230854	C18309W2P5A14	TYPE A 3P PG9 BLACK V0, NBR PROFILE GASKET & SCREW, UL LISTED, IP67 COMPLIANT, SINGLE BAGGED
1210230855	C183M0W31AFSA	TYPE A 3P M20x15 BLACK V0, NBR PROFILE GASKET WITH SCREW MOUNTED, UL LISTED
1210230657	C18309W21SA	TYPE A 3P PG9 BLACK V0, NBR PROFILE GASKET & SCREW, UL LISTED
1210230809	C18211W21SA	TYPE A 2P PG11 BLACK V0, NBR PROFILE GASKET & SCREW, UL LISTED
1210230861	C18211W23SA	TYPE A 2P PG11 BLACK V0, WHITE SILICONE PROFILE GASKET & SCREW, UL LISTED
1210230344	C18309N22	TYPE A 3P PG9 BLACK PA.6, H12, NBR FLAT GASKET & SCREW
1210230862	C18313T22	TYPE A 3P 1/2" NPTF TRANSPARENT, NBR FLAT GASKET & SCREW
1210230870	C18309G21SA	TYPE A 3P PG9 GRAY, NBR PROFILE GASKET & SCREW, UL LISTED
1210230674	C18209W21SA	TYPE A 2P PG9 BLACK, NBR PROFILE GASKET & SCREW, UL LISTED

SEE SHEET ONE EC NO: IPG2016-0551 DRAWN: JBVRNES 2015/10/09 CHKD: ASHEA 2015/10/12 APPR: SUGRIFIN 2015/11/25	QUALITY SYMBOLS ▽=0 ▽=0	GENERAL TOLERANCES (UNLESS SPECIFIED) <table border="1"> <tr><th colspan="2">mm</th><th>INCH</th></tr> <tr><td>4 PLACES ±---</td><td>±---</td><td></td></tr> <tr><td>3 PLACES ±---</td><td>±---</td><td></td></tr> <tr><td>2 PLACES ±0.1</td><td>±---</td><td></td></tr> <tr><td>1 PLACE ±0.2</td><td>±---</td><td></td></tr> <tr><td colspan="3">ANGULAR ±---</td></tr> </table>	mm		INCH	4 PLACES ±---	±---		3 PLACES ±---	±---		2 PLACES ±0.1	±---		1 PLACE ±0.2	±---		ANGULAR ±---			DIMENSION STYLE MM ONLY DRAWN BY: JOCONNOR DATE: 2011/05/04 CHECKED BY: DMAHER DATE: 2011/05/06 APPROVED BY: EFOLAN DATE: 2011/05/24 MATERIAL NO.	SCALE 2:1 DESIGN UNITS METRIC THIRD ANGLE PROJECTION	TITLE C18 SERIES INTERNAL THREAD MOLEX INCORPORATED DOCUMENT NO. SD-121023-001	SHEET NO. 2 OF 2
	mm		INCH																					
	4 PLACES ±---	±---																						
	3 PLACES ±---	±---																						
2 PLACES ±0.1	±---																							
1 PLACE ±0.2	±---																							
ANGULAR ±---																								
DRAFT WHERE APPLICABLE MUST REMAIN WITHIN DIMENSIONS	SIZE A2	THIS DRAWING CONTAINS INFORMATION THAT IS PROPRIETARY TO MOLEX INCORPORATED AND SHOULD NOT BE USED WITHOUT WRITTEN PERMISSION																						

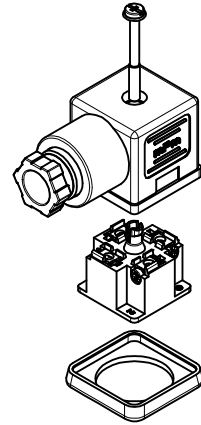
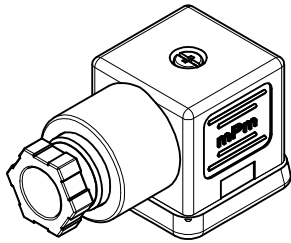

ITEM	DESCRIPTION
1	SCREW
2	COVER ASSEMBLY
3	INSERT ASSEMBLY
4	GASKET

C18209N21**

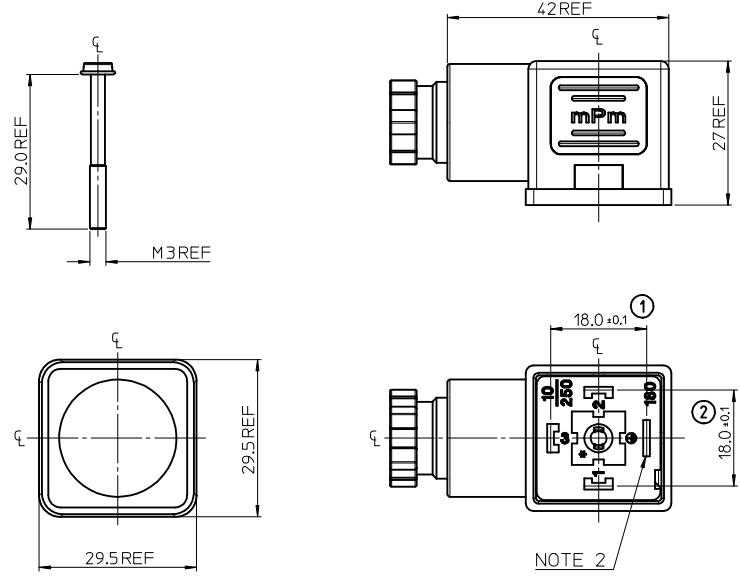

SERIES _____
 C18= INTERNAL THREAD FORM A
 POLES _____
 2= 2 POLE & 3= 3 POLE
 THREAD SIZE _____
 09= PG9, 11= PG11, M6= M16x1.5, M0= M20x1.5, 12= 1/2" GAS, 13= 1/2" NPTF
 39= PG9 W/STRAIN RELIEF, 41= PG11 W/STRAIN RELIEF
 MATERIAL AND HOUSING COLOUR _____
 G = PA6 GRAY, H= PA6 HEAT PROTECTION,
 N= PA6 BLACK, W= PA66 BLACK V0, T= TRANSPARENT
 GROUND POSITION _____
 0= UNMOUNTED, 2= H12, 3= H3, 6= H6 & 9= H9

SCREW AND GASKET _____
 1= NBR PROFILE GASKET & SCREW
 2= NBR FLAT GASKET & SCREW
 3= WHITE SILICONE PROFILE GASKET & SCREW
 4= WHITE SILICONE FLAT GASKET & SCREW
 5= NBR PROFILE GASKET, NO SCREW
 9= NO GASKET, NO SCREW
 0= NO GASKET, NO SCREW
 A= NBR PROFILE GASKET & SCREW +2mm
 B= NBR FLAT GASKET & SCREW +2mm
 C= WHITE SILICONE PROFILE GASKET & SCREW +2mm
 G= NO GASKET & STANDARD SCREW
 I= BULK PACK FULLY MOUNTED, NO GASKET
 P= INTEGRATED NBR GASKET & IP67 SCREW ASSEMBLED
 R= INTEGRATED NBR GASKET & IP67 SCREW NOT ASSEMBLED

NON STANDARD COMPONENTS
 14= SINGLE BAG
 19= PIN NO.3 NON CONNECTED/REMOVED,
 23= ASSEMBLED SCREWS & GASKET
 10= SPECIAL GROMMET
 4S= SPECIAL GROMMET
 5A= SINGLE BAGGED 500 IN A BOX
 9V= NO SCREW OR GASKET
 AF= CENTRE SCREW MOUNTED
 BM= GOLD TERMINALS
 BS= FULLY UNMOUNTED ALL COMPONENTS IN SEPARATE BAGS
 OH= INOX SCREW
 P7= IP67 COMPLIANT
 SA= UL LISTED PART

NOTES
 1. PLEASE SEE SHEET 2 FOR CURRENTLY CONFIGURED PART NUMBERS, FOR SPECIFIC PART NUMBERS PLEASE CONTACT SALES OR CONSULT THE INTELLIGENT PART NUMBERS IN THE TABLE ATTACHED
 2. EARTH POSITION SHOWN, H12.
 3. FOR PACKAGING SEE PACKAGING SPEC PK-121023-C18
 4. PRODUCT SPEC: SEE PS-121201-001
 LAST INSPECTION NUMBER 2

NOTE 2

ADDED P/N EC NO: IFC2016-0551 DRWN: JBYRNES 2015/10/09 CHKD: DSHEA 2015/10/12 APPR: STGERLFIN 2015/11/25	DESCRIPTION REV	QUALITY SYMBOLS ▽=0 ▽=0	GENERAL TOLERANCES (UNLESS SPECIFIED) <table border="1"> <thead> <tr> <th></th> <th>mm</th> <th>INCH</th> </tr> </thead> <tbody> <tr> <td>4 PLACES</td> <td>±---</td> <td>±---</td> </tr> <tr> <td>3 PLACES</td> <td>±---</td> <td>±---</td> </tr> <tr> <td>2 PLACES</td> <td>±0.1</td> <td>±---</td> </tr> <tr> <td>1 PLACE</td> <td>±0.2</td> <td>±---</td> </tr> <tr> <td colspan="3">ANGULAR ±---°</td> </tr> </tbody> </table>		mm	INCH	4 PLACES	±---	±---	3 PLACES	±---	±---	2 PLACES	±0.1	±---	1 PLACE	±0.2	±---	ANGULAR ±---°			DIMENSION STYLE MM ONLY	SCALE 1.5:1	DESIGN UNITS METRIC	THIRD ANGLE PROJECTION
			mm	INCH																					
4 PLACES	±---	±---																							
3 PLACES	±---	±---																							
2 PLACES	±0.1	±---																							
1 PLACE	±0.2	±---																							
ANGULAR ±---°																									
DRAWN BY JOCONNOR 2011/05/04	DATE 2011/05/04	TITLE C18 SERIES INTERNAL THREAD	APPROVED BY EFO LAN 2011/05/24	DATE 2011/05/24	MATERIAL NO. SEE SHEET 2	DOCUMENT NO. SD-121023-001	SHEET NO. 1 OF 2																		
DRAFT WHERE APPLICABLE MUST REMAIN WITHIN DIMENSIONS			THIS DRAWING CONTAINS INFORMATION THAT IS PROPRIETARY TO MOLEX INCORPORATED AND SHOULD NOT BE USED WITHOUT WRITTEN PERMISSION																						

13	12	11	10	9	8	7	6	5	4	3	2	1
PART No.	mPm PART No.	DESCRIPTION										
1210230229	C18209G21	TYPE A 2P PG9 GRAY, NBR PROFILE GASKET & SCREW										
1210230231	C18209G22	TYPE A 2P PG9 GRAY, NBR FLAT GASKET & SCREW										
1210230233	C18209G31	TYPE A 2P PG9 GRAY, NBR PROFILE GASKET & SCREW										
-	-	-										
1210230238	C18209N21	TYPE A 2P PG9 BLACK, NBR PROFILE GASKET & SCREW										
1210230242	C18209N22	TYPE A 2P PG9 BLACK, NBR FLAT GASKET & SCREW										
1210230244	C18209N23	TYPE A 2P PG9 BLACK, WHITE SILICONE PROFILE GASKET & SCREW										
1210230245	C18209N24	TYPE A 2P PG9 BLACK, WHITE SILICONE FLAT GASKET & SCREW										
1210230246	C18209N25	TYPE A 2P PG9 BLACK, NBR PROFILE GASKET, NO SCREW										
1210230249	C18209N2A	TYPE A 2P PG9 BLACK, NBR PROFILE GASKET & SCREW +2mm										
1210230251	C18209N31	TYPE A 2P PG9 BLACK, NBR PROFILE GASKET & SCREW										
1210230252	C18209N61	TYPE A 2P PG9 BLACK, NBR PROFILE GASKET & SCREW										
1210230253	C18209N62	TYPE A 2P PG9 BLACK, NBR FLAT GASKET & SCREW										
1210230254	C18209T21	TYPE A 2P PG9 TRANSPARENT, NBR PROFILE GASKET & SCREW										
1210230271	C18211G21	TYPE A 2P PG11 GRAY, NBR PROFILE GASKET & SCREW										
1210230278	C18211N21	TYPE A 2P PG11 BLACK, NBR PROFILE GASKET & SCREW										
1210230282	C18211N23	TYPE A 2P PG11 BLACK, WHITE SILICONE PROFILE GASKET & SCREW										
1210230283	C18211N24	TYPE A 2P PG11 BLACK, WHITE SILICONE FLAT GASKET & SCREW										
1210230284	C18211N61	TYPE A 2P PG11 BLACK, NBR PROFILE GASKET & SCREW										
1210230286	C18211T21	TYPE A 2P PG11 TRANSPARENT, NBR PROFILE GASKET & SCREW										
1210230291	C18211W21	TYPE A 2P PG11 BLACK V0, NBR PROFILE GASKET & SCREW										
1210230305	C18212N21	TYPE A 2P 1/2" GAS BLACK, NBR PROFILE GASKET & SCREW										
1210230315	C18213G21	TYPE A 2P 1/2" NPTF GRAY, NBR PROFILE GASKET & SCREW										
1210230319	C18213N21	TYPE A 2P 1/2" NPTF BLACK, NBR PROFILE GASKET & SCREW										
1210230328	C18239G21	TYPE A 2P PG9 W/STRAIN RELIEF GRAY, NBR PROFILE GASKET & SCREW										
1210230331	C18241N21	TYPE A 2P PG11 W/STRAIN RELIEF BLACK, NBR PROFILE GASKET & SCREW										
1210230336	C18309G21	TYPE A 3P PG9 GRAY, NBR PROFILE GASKET & SCREW										
1210230337	C18309G22	TYPE A 3P PG9 GRAY, NBR FLAT GASKET & SCREW										
1210230341	C18309N21	TYPE A 3P PG9 BLACK, NBR PROFILE GASKET & SCREW										
1210230345	C18309N23	TYPE A 3P PG9 BLACK, WHITE SILICONE PROFILE GASKET & SCREW										
1210230346	C18309N24	TYPE A 3P PG9 BLACK, WHITE SILICONE FLAT GASKET & SCREW										
1210230352	C18309N2G	TYPE A 3P PG9 BLACK, NO GASKET, & STANDARD SCREW										
1210230354	C18309N61	TYPE A 3P PG9 BLACK, NBR PROFILE GASKET & SCREW										
1210230356	C18309N64	TYPE A 3P PG9 BLACK, WHITE SILICONE FLAT GASKET & SCREW										
1210230358	C18309T21	TYPE A 3P PG9 TRANSPARENT, NBR PROFILE GASKET & SCREW										
1210230364	C18309W21	TYPE A 3P PG9 BLACK V0, NBR PROFILE GASKET & SCREW										
1210230367	C18309W23	TYPE A 3P PG9 BLACK V0, WHITE SILICONE PROFILE GASKET & SCREW										
1210230372	C18311G21	TYPE A 3P PG11 GRAY, NBR PROFILE GASKET & SCREW										
1210230373	C18311G22	TYPE A 3P PG11 GRAY, NBR FLAT GASKET & SCREW										
1210230374	C18311G61	TYPE A 3P PG11 GRAY, NBR PROFILE GASKET & SCREW										
1210230377	C18311N21	TYPE A 3P PG11 BLACK, NBR PROFILE GASKET & SCREW										
1210230378	C18311N22	TYPE A 3P PG11 BLACK, NBR FLAT GASKET & SCREW										
1210230379	C18311N31	TYPE A 3P PG11 BLACK, NBR PROFILE GASKET & SCREW										
1210230382	C18311N61	TYPE A 3P PG11 BLACK, NBR PROFILE GASKET & SCREW										
1210230384	C18311T21	TYPE A 3P PG11 TRANSPARENT, NBR PROFILE GASKET & SCREW										
1210230388	C18311W21	TYPE A 3P PG11 BLACK V0, NBR PROFILE GASKET & SCREW										
1210230400	C18312N21	TYPE A 3P 1/2" GAS BLACK, NBR PROFILE GASKET & SCREW										
1210230401	C18312N22	TYPE A 3P 1/2" GAS BLACK, NBR FLAT GASKET & SCREW										
1210230410	C18313G21	TYPE A 3P 1/2" NPTF GRAY, NBR PROFILE GASKET & SCREW										
1210230414	C18313N21	TYPE A 3P 1/2" NPTF BLACK, NBR PROFILE GASKET & SCREW										
1210230415	C18313N22	TYPE A 3P 1/2" NPTF BLACK, NBR FLAT GASKET & SCREW										
1210230421	C18339N23	TYPE A 3P PG9 W/STRAIN RELIEF BLACK, WHITE SILICONE PROFILE GASKET & SCREW										
1210230422	C18339N2C	TYPE A 3P PG9 W/STRAIN RELIEF BLACK, WHITE SILICONE PROFILE GASKET, & SCREW +2mm										
1210230645	C183M6N21	TYPE A 3P M16x15 BLACK, NBR PROFILE GASKET & SCREW										
1210230656	C183M6G21	TYPE A 3P M16x15 GRAY, NBR PROFILE GASKET & SCREW										
1210230660	C183M0N21	TYPE A 3P M20x15 BLACK, NBR PROFILE GASKET & SCREW										
1210230662	C182M0N21	TYPE A 2P M20x15 BLACK, NBR PROFILE GASKET & SCREW										
1210230677	C182M6N21	TYPE A 2P M16x15 BLACK, NBR PROFILE GASKET & SCREW										
1210230704	C182M6N22	TYPE A 2P M16x15 BLACK, NBR FLAT GASKET & SCREW										
1210230718	C182M6G21	TYPE A 2P M16x15 GRAY, NBR PROFILE GASKET & SCREW										
1210230741	C183M0N2G	TYPE A 3P M20x15 BLACK, NO GASKET, & STANDARD SCREW										
1210230745	C18209N21	TYPE A 2P PG9 BLACK, NBR PROFILE GASKET & SCREW										
1210230763	C18311W2G	TYPE A 3P PG11 BLACK V0, NO GASKET, & STANDARD SCREW										
1210230768	C18213T22	TYPE A 2P 1/2" NPTF TRANSPARENT, NBR FLAT GASKET & SCREW										
1210230780	C18312N23	TYPE A 3P 1/2" GAS BLACK, WHITE SILICONE PROFILE GASKET & SCREW										
1210230793	C18309N2A	TYPE A 3P PG9 BLACK, NBR PROFILE GASKET & SCREW +2mm										

PART No.	mPm PART No.	DESCRIPTION
1210230800	C18209G2B	TYPE A 2P PG9 GRAY, NBR FLAT GASKET, & SCREW +2mm
1210230803	C182M0N2A	TYPE A 2P M20x15 BLACK, NBR PROFILE GASKET & SCREW +2mm
1210230804	C18309N33	TYPE A 3P PG9 BLACK, WHITE SILICONE PROFILE GASKET & SCREW
1210230807	C18309N2R	TYPE A 3P PG9 BLACK, INTEGRATED NBR GASKET & IP67 SCREW NOT ASSEMBLED
1210230825	C182M6N2P	TYPE A 2P M16x15 BLACK, INTEGRATED NBR GASKET & IP67 SCREW ASSEMBLED
1210230833	C18211G2A	TYPE A 2P PG11 GRAY, NBR PROFILE GASKET & SCREW +2mm
1210230841	C182M0G21	TYPE A 2P M20x15 GRAY, NBR PROFILE GASKET & SCREW
1210240268	C18311N2G	TYPE A 3P PG11 BLACK, NO GASKET, & STANDARD SCREW
1210240370	C18211N2A	TYPE A 2P PG11 BLACK, NBR PROFILE GASKET & SCREW +2mm
1210240940	C18209N20	TYPE A 2P PG9 BLACK, NO GASKET, NO SCREW
1210240133	C18209N210H	TYPE A 2P PG9 BLACK, NBR PROFILE GASKET, STAINLESS STEEL SCREW
1210240154	C18209N220H	TYPE A 2P PG9 BLACK, NBR FLAT GASKET, STAINLESS STEEL SCREW
1210240378	C18311N210H	TYPE A 3P PG11 BLACK, NBR PROFILE GASKET, STAINLESS STEEL SCREW
1210240139	C18209N2114	TYPE A 2P PG9 BLACK, NBR PROFILE GASKET & SCREW IN NEUTRAL BAG
1210240156	C18209N2214	TYPE A 2P PG9 BLACK, NBR FLAT GASKET & SCREW IN NEUTRAL BAG
1210240224	C18309N2114	TYPE A 3P PG9 BLACK, NBR PROFILE GASKET & SCREW IN NEUTRAL BAG
1210240755	C18309N2R19	TYPE A 3P PG9 BLACK, INTEGRATED NBR GASKET & IP67 SCREW NOT ASSEMBLED W/O PIN No. 3
1210240227	C18309N2110	TYPE A 3P PG9 BLACK, NBR PROFILE GASKET & SCREW, WITH SPECIAL GROMMET
1210240185	C18211G2123	TYPE A 2P PG11 GRAY, NBR PROFILE GASKET & SCREW, FULLY MOUNTED
1210240271	C18311N614S	TYPE A 3P PG11 BLACK, NBR PROFILE GASKET & SCREW, WITH SPECIAL GROMMET
1210240265	C18311N215A	TYPE A 3P PG11 BLACK, NBR PROFILE GASKET & SCREW, SINGLE BAGGED, 500 IN A BOX
1210230350	C18309N299V	TYPE A 3P PG9 BLACK, NO GASKET, NO SCREW
1210240167	C18209N299V	TYPE A 2P PG9 BLACK, NO GASKET, NO SCREW
1210230232	C18209G22AF	TYPE A 2P PG9 GRAY, NBR FLAT GASKET WITH SCREW MOUNTED
1210230243	C18209N22AF	TYPE A 2P PG9 BLACK, NBR FLAT GASKET WITH SCREW MOUNTED
1210230274	C18211G22AF	TYPE A 2P PG11 GRAY, NBR FLAT GASKET WITH SCREW MOUNTED
1210230281	C18211N22AF	TYPE A 2P PG11 BLACK, NBR FLAT GASKET WITH SCREW MOUNTED
1210230648	C18309N31AF	TYPE A 3P PG9 BLACK, NBR PROFILE GASKET WITH SCREW MOUNTED
1210230678	C183M0N31AF	TYPE A 3P M20x15 BLACK, NBR PROFILE GASKET WITH SCREW MOUNTED
1210230696	C183M6N21AF	TYPE A 3P M16x15 BLACK, NBR PROFILE GASKET WITH SCREW MOUNTED
1210230751	C183M6N31AF	TYPE A 3P M16x15 BLACK, NBR PROFILE GASKET WITH SCREW MOUNTED
1210230801	C183M6N22AF	TYPE A 3P M16x15 BLACK, NBR FLAT GASKET WITH SCREW MOUNTED
1210230767	C18311N318M	TYPE A 3P PG11 BLACK, NBR PROFILE GASKET & SCREW, WITH GOLD TERMINALS
1210230728	C18209N21BS	TYPE A 2P PG9 BLACK, NBR PROFILE GASKET & SCREW, FULLY UNMOUNTED
1210230240	C18209N21P7	TYPE A 2P PG9 BLACK, NBR PROFILE GASKET & SCREW, IP67 COMPLIANT
1210230272	C18211G21P7	TYPE A 2P PG11 GRAY, NBR PROFILE GASKET IP67 COMPLIANT
1210230279	C18211N21P7	TYPE A 2P PG11 BLACK, NBR PROFILE GASKET & SCREW, IP67 COMPLIANT
1210230420	C18309N21P7	TYPE A 3P PG9 W/STRAIN RELIEF BLACK, NBR PROFILE GASKET & SCREW, IP67 COMPLIANT
1210230725	C18309N21P7	TYPE A 3P PG9 BLACK, NBR PROFILE GASKET & SCREW, IP67 COMPLIANT
1210230731	C18312N21P7	TYPE A 3P 1/2" GAS BLACK, NBR PROFILE GASKET & SCREW IP67 COMPLIANT
1210230732	C18209G21P7	TYPE A 2P PG9 GRAY, NBR PROFILE GASKET & SCREW IP67 COMPLIANT
1210230843	C183M6N21P7	TYPE A 3P M16x15 BLACK, NBR PROFILE GASKET & SCREW IP67 COMPLIANT
1210230849	C18309N21	TYPE A 3P PG9 BLACK, BULK PACK FULLY MOUNTED, NO GASKET
1210230739	C18311W21SA	TYPE A 3P PG11 BLACK V0, NBR PROFILE GASKET & SCREW, UL LISTED
1210230851	C182M6W21SA	TYPE A 2P M16x15 BLACK V0, NBR PROFILE GASKET UL LISTED
1210230853	C18311N21P7	TYPE A 3P PG11 BLACK, NBR PROFILE GASKET & SCREW, IP67 COMPLIANT
1210230854	C18309W2P5A14	TYPE A 3P PG9 BLACK V0, NBR PROFILE GASKET & SCREW, UL LISTED, IP67 COMPLIANT, SINGLE BAGGED
1210230855	C183M0W31AFSA	TYPE A 3P M20x15 BLACK V0, NBR PROFILE GASKET WITH SCREW MOUNTED, UL LISTED
1210230657	C18309W21SA	TYPE A 3P PG9 BLACK V0, NBR PROFILE GASKET & SCREW, UL LISTED
1210230809	C18211W21SA	TYPE A 2P PG11 BLACK V0, NBR PROFILE GASKET & SCREW, UL LISTED
1210230861	C18211W23SA	TYPE A 2P PG11 BLACK V0, WHITE SILICONE PROFILE GASKET & SCREW, UL LISTED
1210230344	C18309N22	TYPE A 3P PG9 BLACK PA.6, H12, NBR FLAT GASKET & SCREW
1210230862	C18313T22	TYPE A 3P 1/2" NPTF TRANSPARENT, NBR FLAT GASKET & SCREW
1210230870	C18309G21SA	TYPE A 3P PG9 GRAY, NBR PROFILE GASKET & SCREW, UL LISTED
1210230674	C18209W21SA	TYPE A 2P PG9 BLACK, NBR PROFILE GASKET & SCREW, UL LISTED

SEE SHEET ONE EC NO: IPG2016-0551 DRAWN: JBVRNES 2015/10/09 CHKD: ASHEA 2015/10/12 APPR: SUGRFIN 2015/11/25	QUALITY SYMBOLS ▽=0 ▽=0	GENERAL TOLERANCES (UNLESS SPECIFIED) <table border="1"> <tr> <th></th> <th>mm</th> <th>INCH</th> </tr> <tr> <td>4 PLACES ±---</td> <td>±---</td> <td>±---</td> </tr> <tr> <td>3 PLACES ±---</td> <td>±---</td> <td>±---</td> </tr> <tr> <td>2 PLACES ±0.1</td> <td>±---</td> <td>±---</td> </tr> <tr> <td>1 PLACE ±0.2</td> <td>±---</td> <td>±---</td> </tr> </table>		mm	INCH	4 PLACES ±---	±---	±---	3 PLACES ±---	±---	±---	2 PLACES ±0.1	±---	±---	1 PLACE ±0.2	±---	±---	DIMENSION STYLE MM ONLY	SCALE 2:1	DESIGN UNITS METRIC	THIRD ANGLE PROJECTION
		mm	INCH																		
	4 PLACES ±---	±---	±---																		
	3 PLACES ±---	±---	±---																		
2 PLACES ±0.1	±---	±---																			
1 PLACE ±0.2	±---	±---																			
DRAWN BY JOCONNOR 2011/05/04 CHECKED BY DMAHER 2011/05/06 APPROVED BY EFOLAN 2011/05/24	MATERIAL NO. SEE CHART	TITLE C18 SERIES INTERNAL THREAD	DOCUMENT NO. SD-121023-001	SHEET NO. 2 OF 2																	
DRAFT WHERE APPLICABLE MUST REMAIN WITHIN DIMENSIONS		THIS DRAWING CONTAINS INFORMATION THAT IS PROPRIETARY TO MOLEX INCORPORATED AND SHOULD NOT BE USED WITHOUT WRITTEN PERMISSION																			
REV	DESCRIPTION																				

X-ON Electronics

Largest Supplier of Electrical and Electronic Components

Click to view similar products for [Circular DIN Connectors](#) category:

Click to view products by [Molex](#) manufacturer:

Other Similar products are found below :

[60KD4M](#) [CTVP00RW-19-32S\(506\)](#) [M83723/76W22326](#) [M83723/78R22327](#) [D38999/26FE99SN L/C](#) [7547401103P](#) [75-474014-07L](#) [88-559975-75P](#) [8R3006A18M0033](#) [PT02E1283P](#) [GTC00G-24-7S](#) [PT05A-14-5SX](#) [PT05A1832SW](#) [PT05E2255PW](#) [PT05SE1832SWLC](#) [PT05SE1832SYLC](#) [GTC030-20-27PW-LC](#) [GTC030A-20-33S](#) [PT06SE1811SXLC](#) [1211290078](#) [1211810025](#) [1210120122](#) [ACC06AF-20-23P\(003\)](#) [1210503216](#) [1211290084](#) [1211500027](#) [ACS06AF-16-10P\(003\)](#) [D38999/40FB35AN](#) [D38999/40FB35BB](#) [D38999/40WB35BN](#) [D38999/40WD35PN](#) [D38999/40WJ29SN-L/C](#) [D38999/40WJ4BN](#) [D38999/42FB35BN](#) [D38999/42WB35AB](#) [D38999/42WB35PB-L/C](#) [D38999/42WJ19AN](#) [D38999/42WJ24PN-L/C](#) [D38999/44WB35AN](#) [D38999/44WD35BN](#) [D38999/44WH21AN](#) [D38999/44WH35AN](#) [D38999/44WJ29BA](#) [D38999/44WJ35PN](#) [D38999/44WJ61BA](#) [D38999/46FB35AC](#) [D38999/46FB35BN](#) [D38999/46FB35SA-L/C](#) [D38999/46FB99BA](#) [D38999/46FB99BN](#)