

**PLEASE CHECK WWW.MOLEX.COM FOR LATEST PART INFORMATION**

**Part Number:** [1722872306](#)  
**Status:** **Active**  
**Overview:** [Ultra-Fit Power Connectors](#)  
**Description:** Ultra-Fit Vertical Header, 3.50mm Pitch, Single Row, 6 Circuits, with Solder Clips, 0.76µm Gold (Au) Plating, Natural, Glow-Wire Capable

**Documents:**

<a href="#">3D Model</a>	<a href="#">Product Specification PS-172323-0001-001 (PDF)</a>
<a href="#">Drawing (PDF)</a>	<a href="#">Application Specification AS-172323-0001-001 (PDF)</a>
<a href="#">3D Model (PDF)</a>	<a href="#">Packaging Specification PK-172287-9001-001 (PDF)</a>
<a href="#">Product Specification 1723230001-TS-000 (PDF)</a>	<a href="#">Symbol Footprint Data 1722871106-000 (PDF)</a>
<a href="#">Product Specification 1723231000-PS-CH-000 (PDF)</a>	<a href="#">Symbol Footprint Data SYM-172287-1106-001 (PDF)</a>
<a href="#">Product Specification 1723231000-PS-ES-000 (PDF)</a>	<a href="#">RoHS Certificate of Compliance (PDF)</a>
<a href="#">Product Specification 1723231000-PS-JP-000 (PDF)</a>	<a href="#">Product Literature (PDF)</a>
<a href="#">Product Specification 1723231000-PS-SK-000 (PDF)</a>	

**Agency Certification**

CSA	LR19980
UL	E29179

**General**

Product Family	PCB Headers
Series	<a href="#">172287</a>
Application	Power, Wire-to-Board
Comments	See Product Specification for maximum current rating by circuit size and wire AWG
Overview	<a href="#">Ultra-Fit Power Connectors</a>
Product Name	Ultra-Fit
UPC	887191737089

**Physical**

Breakaway	No
Circuits (Loaded)	6
Circuits (maximum)	6
Color - Resin	Natural
Durability (mating cycles max)	200
First Mate / Last Break	No
Flammability	94V-0
Glow-Wire Capable	Yes
Guide to Mating Part	No
Keying to Mating Part	Yes
Lock to Mating Part	Yes
Material - Metal	Copper Alloy
Material - Plating Mating	Gold
Material - Plating Termination	Tin
Material - Resin	Liquid Crystal Polymer
Net Weight	1.926/g
Number of Rows	1
Orientation	Vertical
PC Tail Length	3.20mm
PCB Locator	Yes
PCB Retention	Yes
PCB Thickness - Recommended	1.60mm
Packaging Type	Tray
Pitch - Mating Interface	3.50mm
Pitch - Termination Interface	3.50mm
Plating min - Mating	0.762µm

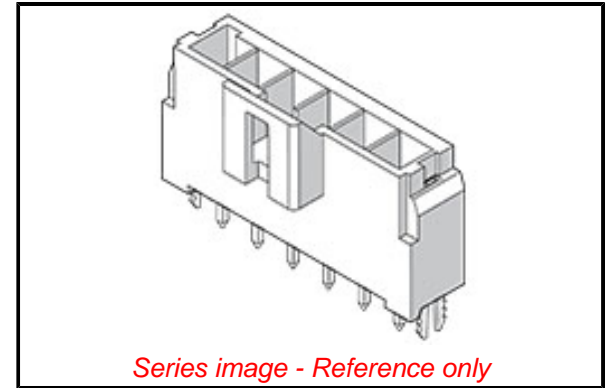

*Series image - Reference only*

**EU ELV**

**Not Relevant**

**EU RoHS**

**Compliant**

**REACH SVHC**

Not Contained Per -  
D(2020)9139-DC (19  
Jan 2021)

**Halogen-Free**

**Status**

**Low-Halogen**

For more information, please visit [Contact US](#)

China ROHS

ELV

RoHS Phthalates

**China RoHS**

Green Image

Not Relevant

Not Contained

**Search Parts in this Series**

[172287 Series](#)

**Mates With**

Ultra-Fit Receptacle Housing [1722564106](#)

Plating min - Termination	1.524µm
Polarized to Mating Part	Yes
Polarized to PCB	Yes
Shrouded	Fully
Surface Mount Compatible (SMC)	Yes
Temperature Range - Operating	-40° to +120°C
Termination Interface: Style	Through Hole

**Electrical**

Current - Maximum per Contact	12.0A
Voltage - Maximum	400V AC (RMS)/DC

**Solder Process Data**

Duration at Max. Process Temperature (seconds)	090
Lead-free Process Capability	WAVE
Max. Cycles at Max. Process Temperature	002
Process Temperature max. C	260

**Material Info****Reference - Drawing Numbers**

Application Specification	AS-172323-0001-001
Packaging Specification	PK-172287-9001-001
Product Specification	1723230001-TS-000, 1723231000-PS-CH-000, 1723231000-PS-ES-000, 1723231000-PS-JP-000, 1723231000-PS-SK-000, PS-172323-0001-001
Sales Drawing	SD-172287-1000-000
Symbol/Footprint Data	1722871106-000, SYM-172287-1106-001

This document was generated on 08/23/2021

**PLEASE CHECK [WWW.MOLEX.COM](http://WWW.MOLEX.COM) FOR LATEST PART INFORMATION**

## X-ON Electronics

Largest Supplier of Electrical and Electronic Components

*Click to view similar products for [Headers & Wire Housings](#) category:*

*Click to view products by [Molex](#) manufacturer:*

Other Similar products are found below :

[892-18-020-10-001101](#) [58102-G61-06LF](#) [582553-1](#) [0009485154](#) [009176003701906](#) [0050291907](#) [LY20-4P-DT1-P1E-BR](#) [02.125.8002.8](#)  
[609-3404](#) [61062-3](#) [622-0430](#) [622-3653LF](#) [63453-116](#) [636-1030](#) [636-1427](#) [636-3427](#) [636-4007](#) [641938-9](#) [641991-4](#) [644827-2](#) [65817-010LF](#)  
[65817-015LF](#) [65863-015LF](#) [66207-023LF](#) [67095-007LF](#) [67601157](#) [68648-049](#) [70.362.1628.0](#) [70-4210](#) [70-4226B](#) [70-4853B](#) [707-5020](#) [707-](#)  
[5028](#) [71.350.2428.0](#) [71918-208LF](#) [71961-016LF](#) [733-134](#) [733-162](#) [754199-000](#) [760-3052](#) [787-8014-00](#) [79531-3000](#) [FCN-360C032-B](#) [FCN-](#)  
[367T-T012/H](#) [FCN-723D010/2](#) [80.063.4001.1](#) [800-90-001-10-001000](#) [800-90-010-10-002000](#) [801-43-002-10-013000](#) [801-43-006-10-002000](#)