

PLEASE CHECK WWW.MOLEX.COM FOR LATEST PART INFORMATION

Part Number: [1731091921](#)
Status: **Active**
Overview: [FCT D-Sub Connectors](#)
Description: FCT Standard-Density D-Sub Connector, Female, Right-Angle, Surface Mount, 7.30mm Contact Height, 500 Mating Cycles, Diecast Bracket, 9 Circuits

Documents:

[Brochure \(PDF\)](#)

[RoHS Certificate of Compliance \(PDF\)](#)

General

Product Family	D-Sub Products
Series	173109
IP Rating	IP20
Overview	FCT D-Sub Connectors
Product Category	D-Sub Connector
Product Name	FCT Products
Type	Standard Density
UPC	191130163076

Physical

Circuits (Loaded)	9
Circuits (maximum)	9
Color - Resin	Natural
Durability (mating cycles max)	500
Gender	Female
Material - Contact	Copper Alloy
Material - Resin	PBT
Material - Shell	Steel
Net Weight	17.900/g
Number of Rows	2
Orientation	Right-Angle
PC Tail Length	7.30mm
PCB Locator	Yes
PCB Retention	Yes
PCB Thickness - Recommended	1.60mm
Packaging Type	Embossed Tape on Reel
Panel Mount	Rear
Panel Mount Method	Thread-In
Pitch - Mating Interface	2.84mm
Pitch - Termination Interface	3.40mm
Plating - Contact	Gold over Palladium Nickel
Plating - Shell	Nickel
Polarized to Mating Part	Yes
Polarized to PCB	Yes
Ports	1
Shielded	Yes
Surface Mount Compatible (SMC)	Yes
Temperature Range - Operating	-55° to +150°C
Termination Style	Surface Mount
Waterproof / Dustproof	No
Waterproof / Dustproof Type	IP20

Electrical

Current - Maximum per Contact	5.0A
-------------------------------	------

Material Info

Engineering Number	FSLT09S107G1-3752
--------------------	-------------------

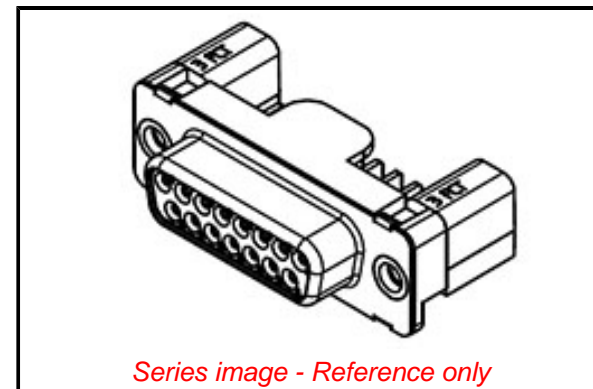

Series image - Reference only

EU ELV

Not Relevant

EU RoHS

Compliant

REACH SVHC

Not Reviewed

Halogen-Free

Status

Not Reviewed

For more information, please visit [Contact US](#)

China ROHS

ELV

RoHS Phthalates

China RoHS

Green Image

Not Relevant

Not Contained

Search Parts in this Series

[173109 Series](#)

Mates With

FCT Standard-Density D-Sub, Size 1, 9 Position, Plug

This document was generated on 12/17/2020

PLEASE CHECK WWW.MOLEX.COM FOR LATEST PART INFORMATION

X-ON Electronics

Largest Supplier of Electrical and Electronic Components

Click to view similar products for [D-Sub Standard Connectors](#) category:

Click to view products by [Molex](#) manufacturer:

Other Similar products are found below :

[56F711-015](#) [LV242999-142T12](#) [015-0341-000](#) [015-0372-005](#) [015-0372-008](#) [015-8755-001](#) [020419-0104](#) [012-0467-000](#) [012-9507-034](#) [012-9507-114](#) [020745-0008](#) [609-25P](#) [CT2-14S-2PCA34](#) [CT2-18-11PCAU](#) [CT6-10SL-3SC](#) [CT6-10SL-4SC](#) [CT6-14S-2SC](#) [CT6E14SA7SC](#)
[M83513/01-FC](#) [M83723/76W24619 L/C](#) [M85049/48-3-2F](#) [6STD09PCM99B70X](#) [6STD09SCM99B30X](#) [6STD09SCT99S40X](#)
[6STD15PCT99S40X](#) [6STD15SCM99B30X](#) [6STD15SCT99S40X](#) [6STF09PCM05B70X](#) [7-135760-9](#) [MC11E-10-6SN](#) [747552-3](#) [MD1-21PS](#)
[MDM-15SCBRM7-F222](#) [MDM96517-699](#) [MDM96521-744](#) [MDVB1-21SL1](#) [MIK0-1-7SH003](#) [MIKQ6-7SH076](#) [MIKQ7-7PH077](#) [MIKQ7-7PH11](#) [MIKQ7-7PH32](#) [MJSV-28SL61](#) [MKJ4A1F14-55S](#) [8-135760-3](#) [8STD09PCM99B30X](#) [PG-KV/PV-16-GROM-SEALING](#) [GDA15P](#)
[GDAY15PB](#) [980-0000-170](#) [980-0000-171](#)