

High Density D-Sub Connectors

High Density D-Sub Steckverbinder

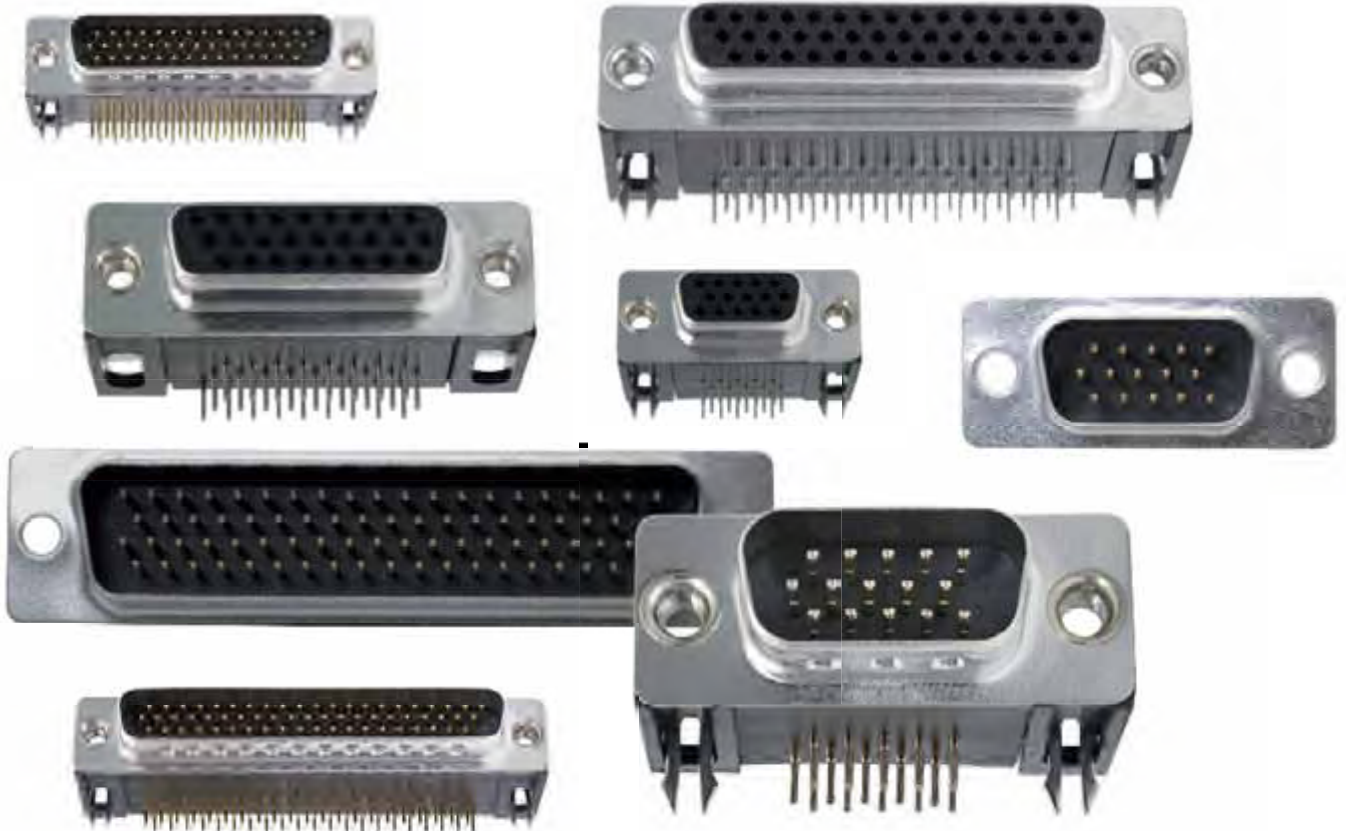

Advantages and Special Features

In terms of their outside dimensions the shells of the high density D-Sub series are the same as for the well known standard D-Sub connectors but the number of contacts has been considerably increased.

Due to the higher density of 15, 26, 44, 62 and 78 contacts, this series is ideally suited for the most modern applications in data transmission and telecommunications as well as in measurement regulation and control devices.

Protection against misalignment or bending of contacts is guaranteed by the use of a trapeze shaped metal shell. The tin plated shells also offer good shielding qualities and are mechanically stable. Because of their compact design and low mounting flange, these connectors can also be used without difficulty in the tried and tested 19"-modules.

These connectors are available in straight and right angled versions for PCBs. They can also be supplied for cable assemblies in solder or crimp version. The heat resistant plastics used in the production of the connectors meet UL94V-0 requirements.

Vorteile und Merkmale im Überblick

Die High Density D-Sub Serie verwendet von den Außenabmessungen die Gehäuse der bekannten Standard D-Sub Steckverbinder, jedoch hat sich die Anzahl der Kontakte wesentlich erhöht.

Durch die höhere Dichte von 15, 26, 44, 62 und 78 Kontakten eignet sich diese Serie hervorragend für modernste Anwendungen der Datentechnik, Telekommunikation sowie Mess-, Regel- und Steuerungstechnik.

Ein sicherer Verdrehenschutz ist durch das trapezförmige Metallgehäuse gewährleistet. Die verzinnnten Gehäuse bieten gute Abschirmeigenschaften und sind mechanisch stabil. Aufgrund der kompakten Bauweise und des niedrigen Montageflansches sind diese Steckverbinder in den bewährten 19"-Einschüben problemlos einsetzbar.

Die Steckverbinder sind in gerader bzw. abgewinkelter Ausführung für Leiterplattenmontage sowie zur Kabelmontage in Löt- oder Crimptechnik lieferbar. Die verwendeten temperaturbeständigen Kunststoffe entsprechen den Anforderungen nach UL94V-0.



Pin: Solder Pot Termination

Stift: Löttopfanschluss

Dimensions
Abmessungen

Pin Connector, Front View
Stiftsteckverbinder, Frontansicht

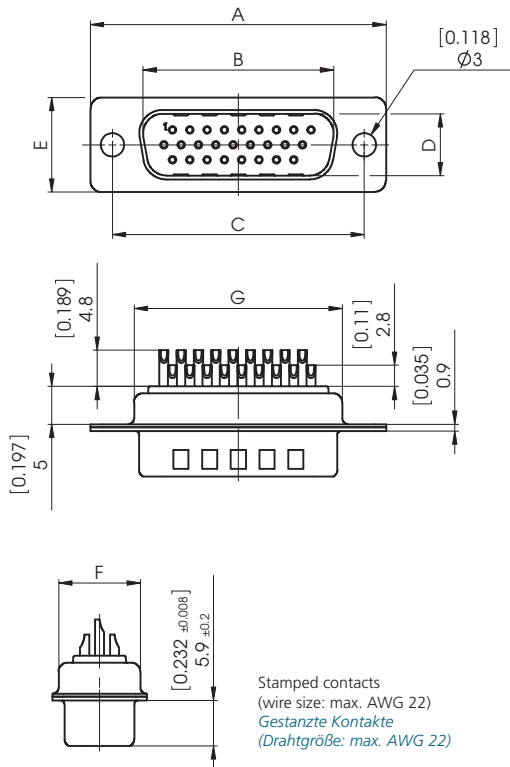

Stamped contacts
(wire size: max. AWG 22)
Gestanzte Kontakte
(Drahtgröße: max. AWG 22)

15 contacts
15 Kontakte

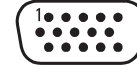

26 contacts
26 Kontakte

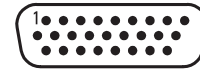

44 contacts
44 Kontakte



62 contacts
62 Kontakte



78 contacts
78 Kontakte

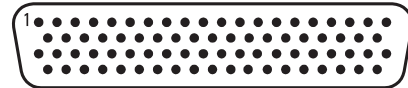

Order Number Bestellnummer	Shell Size Gehäusegröße	Number of Contacts Polzahl	A	B	C	D	E	F	G
			±0,4 (±0.016)	+0,2 (+0.008)	±0,15 (±0.006)	+0,2 (+0.008)	±0,4 (±0.016)	±0,3 (±0.012)	±0,3 (±0.012)
CT09-15P	1	15	30,8 (1.213)	16,9 (0.665)	25,0 (0.984)	8,2 (0.323)	12,5 (0.492)	10,8 (0.425)	19,3 (0.760)
CT15-26P	2	26	39,1 (1.539)	25,2 (0.992)	33,3 (1.311)	8,2 (0.323)	12,5 (0.492)	10,8 (0.425)	27,5 (1.083)
CT25-44P	3	44	53,0 (2.087)	38,9 (1.531)	47,0 (1.852)	8,2 (0.323)	12,5 (0.492)	10,8 (0.425)	41,3 (1.626)
CT37-62P	4	62	69,3 (2.728)	55,3 (2.177)	63,5 (2.500)	8,2 (0.323)	12,5 (0.492)	10,8 (0.425)	57,7 (2.272)
CT50-78P	5	78	66,9 (2.634)	52,8 (2.079)	61,1 (2.406)	11,0 (0.433)	15,4 (0.606)	13,7 (0.539)	55,3 (2.177)

Dimensions in mm (inch) - Abmessungen in mm (inch)

Socket: Solder Pot Termination

Buchse: Löttopfanschluss

Dimensions
Abmessungen

Socket Connector, Front View
Buchsensteckverbinder, Frontansicht

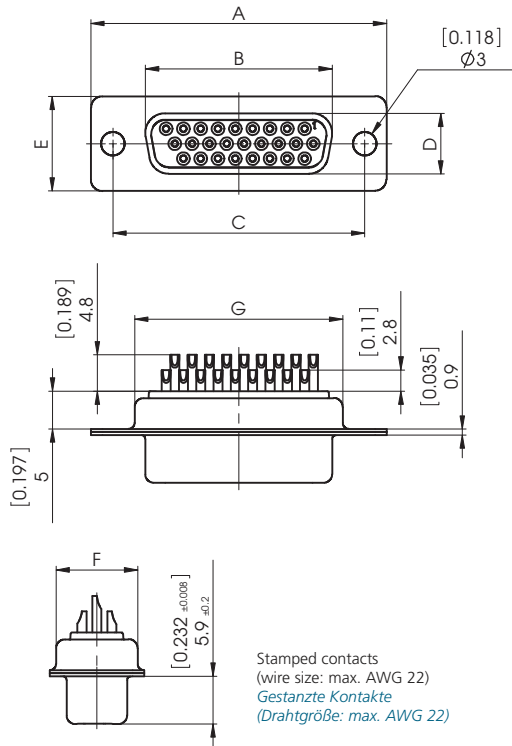

15 contacts
15 Kontakte

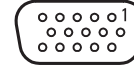

26 contacts
26 Kontakte

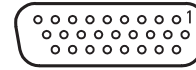

44 contacts
44 Kontakte

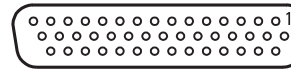

62 contacts
62 Kontakte

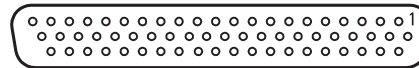

78 contacts
78 Kontakte

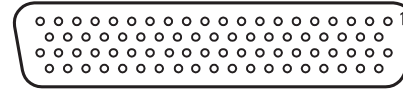

Order Number Bestellnummer	Shell Size Gehäusegröße	Number of Contacts Polzahl	A	B	C	D	E	F	G
			±0,4 (±0.016)	-0,2 (-0.008)	±0,15 (±0.006)	-0,2 (-0.008)	±0,4 (±0.016)	±0,3 (±0.012)	±0,3 (±0.012)
CT09-15S	1	15	30,8 (1.213)	16,4 (0.646)	25,0 (0.984)	8,0 (0.315)	12,5 (0.492)	10,8 (0.425)	19,3 (0.760)
CT15-26S	2	26	39,1 (1.539)	24,7 (0.972)	33,3 (1.311)	8,0 (0.315)	12,5 (0.492)	10,8 (0.425)	27,5 (1.083)
CT25-44S	3	44	53,0 (2.087)	38,5 (1.516)	47,0 (1.852)	8,0 (0.315)	12,5 (0.492)	10,8 (0.425)	41,3 (1.626)
CT37-62S	4	62	69,3 (2.728)	54,9 (2.161)	63,5 (2.500)	8,0 (0.315)	12,5 (0.492)	10,8 (0.425)	57,7 (2.272)
CT50-78S	5	78	66,9 (2.634)	52,5 (2.067)	61,1 (2.406)	10,8 (0.425)	15,4 (0.606)	13,7 (0.539)	55,3 (2.177)

Dimensions in mm (inch) - Abmessungen in mm (inch)



Pin: Straight PCB Termination

Stift: Gerader Leiterplattenanschluss

Dimensions
Abmessungen

Pin Connector, Front View
Stiftsteckverbinder, Frontansicht

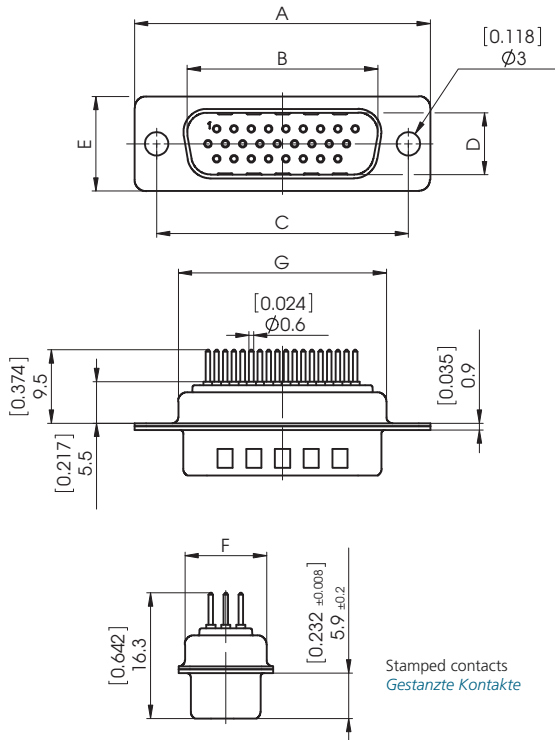

15 contacts
15 Kontakte

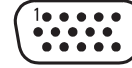

26 contacts
26 Kontakte

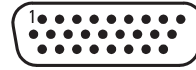

44 contacts
44 Kontakte



62 contacts
62 Kontakte



78 contacts
78 Kontakte

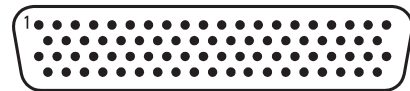

Order Number Bestellnummer	Shell Size Gehäusegröße	Number of Contacts Polzahl	A	B	C	D	E	F	G	H	J
			±0,4 (±0.016)	+0,2 (+0.008)	±0,15 (±0.006)	+0,2 (+0.008)	±0,4 (±0.016)	±0,3 (±0.012)	±0,3 (±0.012)		
CT09-15P1	1	15	30,8 (1.213)	16,9 (0.665)	25,0 (0.984)	8,2 (0.323)	12,5 (0.492)	10,8 (0.425)	19,3 (0.760)	7,10 (0.280)	2,29 (0.090)
CT15-26P1	2	26	39,1 (1.539)	25,2 (0.992)	33,3 (1.311)	8,2 (0.323)	12,5 (0.492)	10,8 (0.425)	27,5 (1.083)	6,80 (0.268)	2,29 (0.090)
CT25-44P1	3	44	53,0 (2.087)	38,9 (1.531)	47,0 (1.852)	8,2 (0.323)	12,5 (0.492)	10,8 (0.425)	41,3 (1.626)	7,00 (0.276)	2,29 (0.090)
CT37-62P1	4	62	69,3 (2.728)	55,3 (2.177)	63,5 (2.500)	8,2 (0.323)	12,5 (0.492)	10,8 (0.425)	57,7 (2.272)	7,00 (0.276)	2,42 (0.095)
CT50-78P1	5	78	66,9 (2.634)	52,8 (2.079)	61,1 (2.406)	11,0 (0.433)	15,4 (0.606)	13,7 (0.539)	55,3 (2.177)	7,60 (0.299)	2,42 (0.095)

Dimensions in mm (inch) - Abmessungen in mm (inch)

PCB Hole Pattern (Mounting Side)
Leiterplattenlochbild (Bestückungsseite)

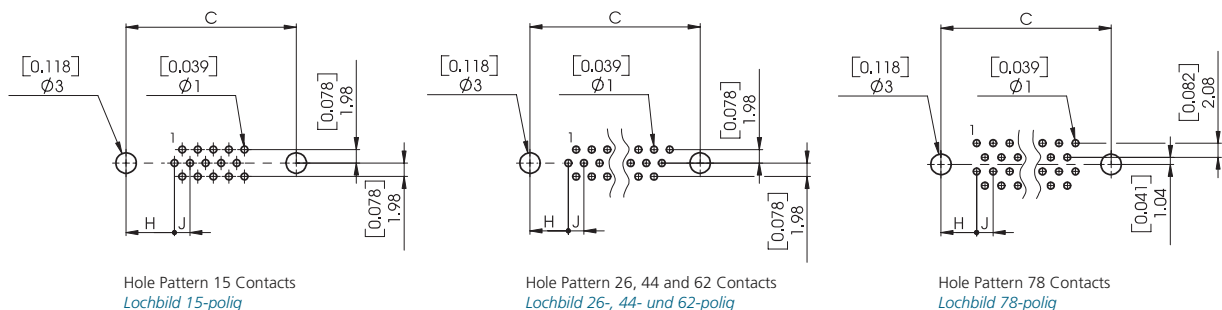

Socket: Straight PCB Termination

Buchse: Gerader Leiterplattenanschluss

Dimensions
Abmessungen

Socket Connector, Front View
Buchsensteckverbinder, Frontansicht

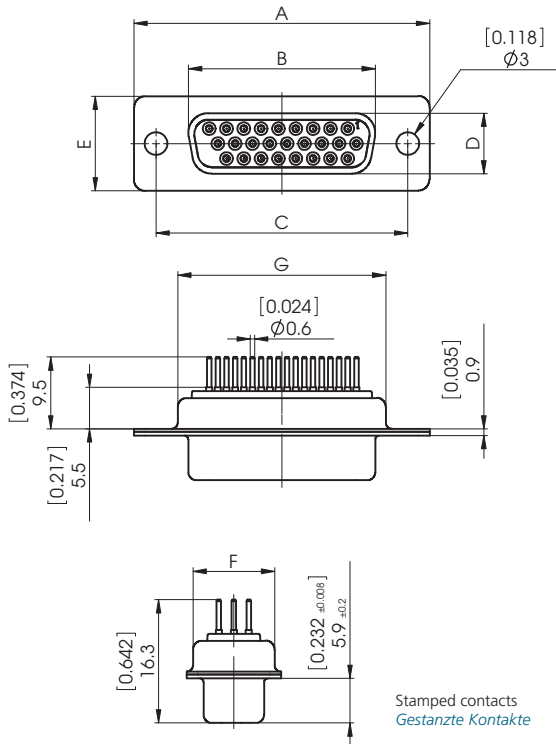

15 contacts
15 Kontakte

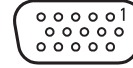

26 contacts
26 Kontakte

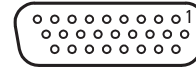

44 contacts
44 Kontakte

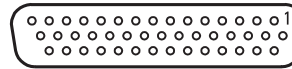

62 contacts
62 Kontakte

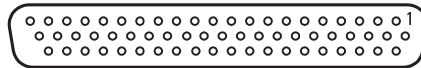

78 contacts
78 Kontakte

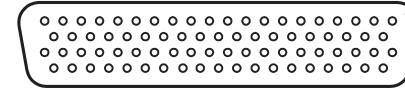

Order Number Bestellnummer	Shell Size Gehäusegröße	Number of Contacts Polzahl	A	B	C	D	E	F	G	H	J
			$\pm 0,4$ (± 0.016)	$-0,2$ (-0.008)	$\pm 0,15$ (± 0.006)	$-0,2$ (-0.008)	$\pm 0,4$ (± 0.016)	$\pm 0,3$ (± 0.012)	$\pm 0,3$ (± 0.012)		
CT09-15S1	1	15	30,8 (1.213)	16,4 (0.646)	25,0 (0.984)	8,0 (0.315)	12,5 (0.492)	10,8 (0.425)	19,3 (0.760)	7,1 (0.280)	2,3 (0.090)
CT15-26S1	2	26	39,1 (1.539)	24,7 (0.972)	33,3 (1.311)	8,0 (0.315)	12,5 (0.492)	10,8 (0.425)	27,5 (1.083)	6,8 (0.268)	2,3 (0.090)
CT25-44S1	3	44	53,0 (2.087)	38,5 (1.516)	47,0 (1.852)	8,0 (0.315)	12,5 (0.492)	10,8 (0.425)	41,3 (1.626)	7,0 (0.276)	2,3 (0.090)
CT37-62S1	4	62	69,3 (2.728)	54,9 (2.161)	63,5 (2.500)	8,0 (0.315)	12,5 (0.492)	10,8 (0.425)	57,7 (2.272)	7,0 (0.276)	2,4 (0.095)
CT50-78S1	5	78	66,9 (2.634)	52,5 (2.067)	61,1 (2.406)	10,8 (0.425)	15,4 (0.606)	13,7 (0.539)	55,3 (2.177)	7,6 (0.299)	2,4 (0.095)

Dimensions in mm (inch) - Abmessungen in mm (inch)

PCB Hole Pattern (Mounting Side)
Leiterplattenlochbild (Bestückungsseite)

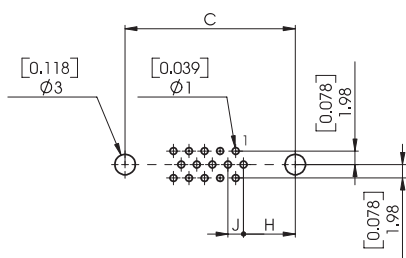

Hole Pattern 15 Contacts
Lochbild 15-polig

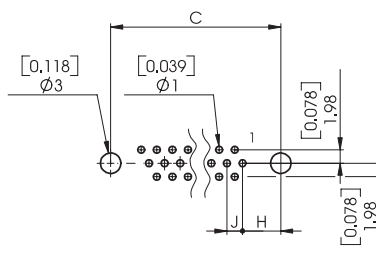

Hole Pattern 26, 44 and 62 Contacts
Lochbild 26-, 44- und 62-polig

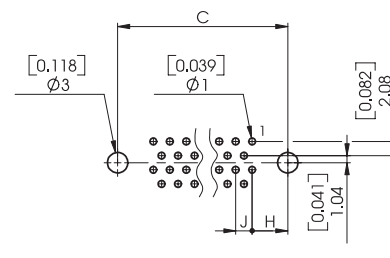

Hole Pattern 78 Contacts
Lochbild 78-polig

Pin: Right Angled PCB Termination

Stift: Abgewinkelter Leiterplattenanschluss

Dimensions
Abmessungen

Pin Connector, Front View
Stiftsteckverbinder, Frontansicht

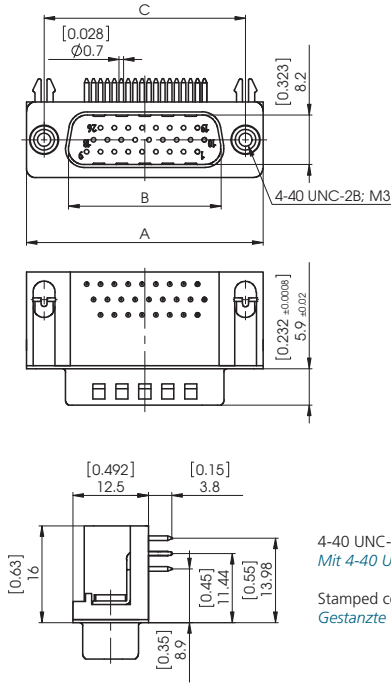

4-40 UNC-2B or M3 clinch nut on connector flange available.
Mit 4-40 UNC-2B bzw. M3 Gewindenut im Steckerflansch lieferbar.

Stamped contacts
Gestanzte Kontakte

15 contacts
15 Kontakte

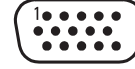

26 contacts
26 Kontakte

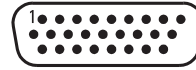

44 contacts
44 Kontakte

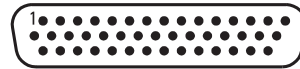

62 contacts
62 Kontakte



Order Number Bestellnummer	Shell Size Gehäusegröße	Number of Contacts Polzahl	A	B	C	H	J		
Grounding Brackets with Snap-in Snap-in Massewinkel	Grounding Brackets with Snap-in Snap-in Massewinkel	Grounding Brackets without Snap-in Massewinkel ohne Snap-in			$\pm 0,4$ (± 0.016)	$+0,2$ ($+0.008$)	$\pm 0,15$ (± 0.006)		
4-40 UNC-2B	M3	4-40 UNC-2B							
CT09-15P5-L228	CT09-15P5-L229	CT09-15P5-L222	1	15	30,8 (1.213)	16,9 (0.665)	25,0 (0.984)	7,10 (0.280)	2,29 (0.090)
CT15-26P5-L228	CT15-26P5-L229	CT15-26P5-L222	2	26	39,1 (1.539)	25,2 (0.992)	33,3 (1.311)	6,80 (0.268)	2,29 (0.090)
CT25-44P5-L228	CT25-44P5-L229	CT25-44P5-L222	3	44	53,0 (2.087)	38,9 (1.531)	47,0 (1.852)	7,00 (0.276)	2,29 (0.090)
CT37-62P5-L228	CT37-62P5-L229	CT37-62P5-L222	4	62	69,3 (2.728)	55,3 (2.177)	63,5 (2.500)	7,00 (0.276)	2,42 (0.095)

Dimensions in mm (inch) - Abmessungen in mm (inch)

PCB Hole Pattern (Mounting Side)
Leiterplattenlochbild (Bestückungsseite)

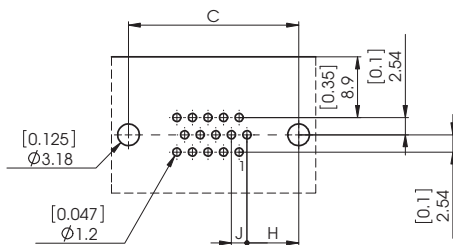

Hole Pattern 15 Contacts
Lochbild 15-polig

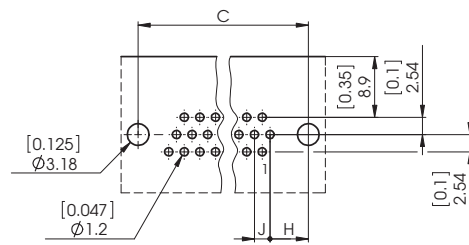

Hole Pattern 26, 44 and 62 Contacts
Lochbild 26-, 44- und 62-polig

Socket: Right Angled PCB Termination

Buchse: Abgewinkelter Leiterplattenanschluss

Dimensions
Abmessungen

Socket Connector, Front View
Buchsensteckverbinder, Frontansicht

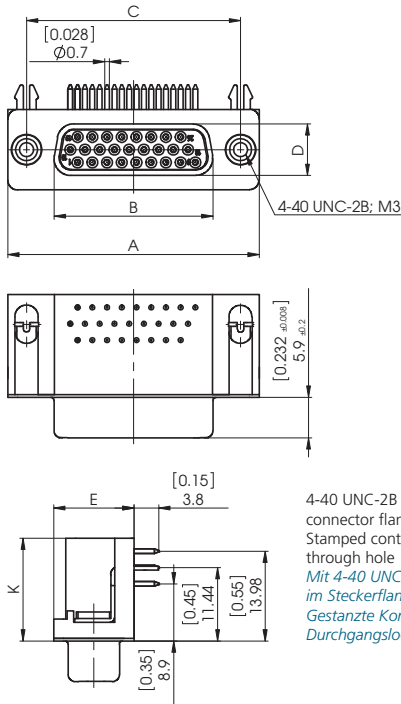

15 contacts
15 Kontakte

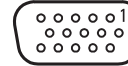

26 contacts
26 Kontakte

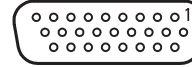

44 contacts
44 Kontakte

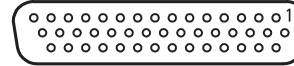

62 contacts
62 Kontakte

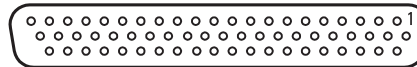

78 contacts
78 Kontakte

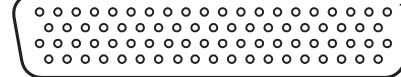

Order Number Bestellnummer	Shell Size Gehäusegröße	No. of Contacts Polzahl	A	B	C	E	H	J	K		
Grounding Brackets with Snap-in Snap-in Massewinkel 4-40 UNC-2B	Grounding Brackets with Snap-in Snap-in Massewinkel M3	Grounding Brackets without Snap-in Massewinkel ohne Snap-in 4-40 UNC-2B	±0,4 (±0.016)	-0,2 (-0.008)	±0,15 (±0.006)	±0,4 (±0.016)					
CT09-15S5-L228	CT09-15S5-L229	CT09-15S5-L222	1	15	30,8 (1.213)	16,4 (0.646)	25,0 (0.984)	12,5 (0.492)	7,10 (0.280)	2,29 (0.090)	16,0 (0.630)
CT15-26S5-L228	CT15-26S5-L229	CT15-26S5-L222	2	26	39,1 (1.539)	24,7 (0.972)	33,3 (1.311)	12,5 (0.492)	6,80 (0.268)	2,29 (0.090)	16,0 (0.630)
CT25-44S5-L228	CT25-44S5-L229	CT25-44S5-L222	3	44	53,0 (2.087)	38,5 (1.516)	47,0 (1.852)	12,5 (0.492)	7,00 (0.276)	2,29 (0.090)	16,0 (0.630)
CT37-62S5-L228	CT37-62S5-L229	CT37-62S5-L222	4	62	69,3 (2.728)	54,9 (2.161)	63,5 (2.500)	12,5 (0.492)	7,00 (0.276)	2,42 (0.095)	16,0 (0.630)
CT50-78S5-L228	CT50-78S5-L229*	—	5	78	66,9 (2.634)	52,5 (2.067)	61,1 (2.406)	13,8 (0.543)	7,60 (0.299)	2,42 (0.095)	17,4 (0.685)

* On request / auf Anfrage Dimensions in mm (inch) - Abmessungen in mm (inch)

PCB Hole Pattern (Mounting Side)
Leiterplattenlochbild (Bestückungsseite)

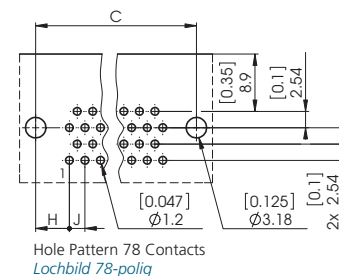
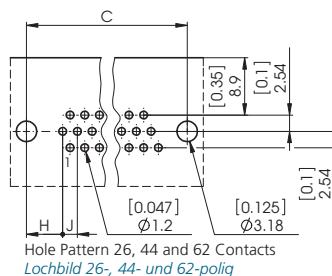
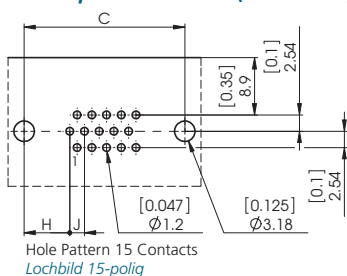

Order Code (High Density D-Sub Connectors)

Bestellschlüssel (High Density D-Sub Steckverbinder)

	CT	W	09-15	S	5	...
<p>High Density D-Sub Series Prefix High Density D-Sub Serienbezeichnung</p>						
<p>Mounting Type Befestigungsarten</p> <p>Standard <i>Standard</i></p> <p>W Float Mounted* <i>Schwimmend*</i></p> <p>T Clinch Nut 4-40 UNC* <i>Einnietmutter 4-40 UNC*</i></p> <p>Z Clinch Nut M3* <i>Einnietmutter M3*</i></p> <p>TS Clinch Nut 4-40 UNC, self locking* <i>Einnietmutter 4-40 UNC, selbstsichernd*</i></p> <p>ZS Clinch Nut M3, self locking* <i>Einnietmutter M3, selbstsichernd*</i></p> <p>* Not with Contact Design 5. / <i>Nicht mit Kontaktvariante 5.</i></p>						
<p>No. of Contacts Polzahl</p> <p>09-15 15 Contacts in shell size 1 (correspond to 9 pin D-Sub standard connector) <i>15-polig in Gehäusegröße 1 (entspricht 9-poligem D-Sub Standard Steckverbindergehäuse)</i></p> <p>15-26 26 Contacts in shell size 2 (correspond to 15 pin D-Sub standard connector) <i>26-polig in Gehäusegröße 2 (entspricht 15-poligem D-Sub Standard Steckverbindergehäuse)</i></p> <p>25-44 44 Contacts in shell size 3 (correspond to 25 pin D-Sub standard connector) <i>44-polig in Gehäusegröße 3 (entspricht 25-poligem D-Sub Standard Steckverbindergehäuse)</i></p> <p>37-62 62 Contacts in shell size 4 (correspond to 37 pin D-Sub standard connector) <i>62-polig in Gehäusegröße 4 (entspricht 37-poligem D-Sub Standard Steckverbindergehäuse)</i></p> <p>50-78 78 Contacts in shell size 5 (correspond to 50 pin D-Sub standard connector) <i>78-polig in Gehäusegröße 5 (entspricht 50-poligem D-Sub Standard Steckverbindergehäuse)</i></p>						
<p>Contact Type Kontaktart</p> <p>P Pin <i>Stift</i></p> <p>S Socket <i>Buchse</i></p>						
<p>Contact Design Kontaktvariante</p> <p>Solder Pot Termination <i>Löttopfanschluss</i></p> <p>1 Straight PCB Termination <i>Gerader Leiterplattenanschluss</i></p> <p>5 Right angled PCB Termination <i>Abgewinkelter Leiterplattenanschluss</i></p> <p>7 Crimp Termination <i>Crimpanschluss</i></p>						
<p>Modifications – for Contact Design 5 only! Modifikationen – nur Kontaktvariante 5!</p> <p>L228 See page 100-101 (supplied with 4-40 UNC clinch nut, plastic bracket and grounding bracket with snap-in) <i>Siehe Seite 100-101 (mit Gewindeniet 4-40 UNC, Kunststoffwinkel und Snap-In Massewinkel)</i></p> <p>L229 See page 100-101 (with M3 clinch nut, plastic bracket and grounding bracket with snap-in) <i>Siehe Seite 100-101 (mit Gewindeniet M3, Kunststoffwinkel und Snap-In Massewinkel)</i></p> <p>L222 See page 100-101 (with 4-40 UNC-2B clinch nut, plastic bracket and grounding bracket with through hole) <i>Siehe Seite 100-101 (mit Gewindeniet 4-40 UNC-2B, Kunststoffwinkel und Snap-In Massewinkel mit Durchgangsloch)</i></p>						

Further modifications are listed in D-Sub Miniature page 16ff.

Weitere Modifikationen sind bei D-Sub Miniatur ab Seite 16 aufgelistet.

Mechanical Data

Mechanische Daten

Mechanical Data	
Mechanische Daten	
Shell	Steel, nickel plated; pin shell with dimples
Gehäuse	Stahl, vernickelt; Stiftgehäuse mit Kontaktnoppen
Insulator	Thermoplastic, glassfilled UL94V-0
Isolierkörper	Thermoplast, glasfaserverstärkt UL94V-0
Signal contacts	Copper alloy, flash gold plated
Signalkontakte	Kupferlegierung, Oberfläche Hauchvergoldung

Panel Cut-Out

Front Mounted

Standard, Front Mounted

Standard, frontseitig montiert

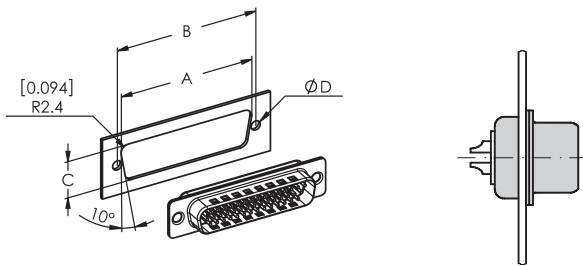

Shell Size	A	B	C
Gehäusegröße	±0,2 (±0.008)	±0,1 (±0.004)	±0,2 (±0.008)
1	22,2 (0.874)	25,0 (0.984)	12,3 (0.484)
2	30,5 (1.201)	33,3 (1.311)	12,3 (0.484)
3	44,3 (1.744)	47,0 (1.850)	12,3 (0.484)
4	60,7 (2.390)	63,5 (2.500)	12,3 (0.484)
5	58,3 (2.295)	61,1 (2.406)	15,1 (0.594)

Dimensions in mm (inch) - Abmessungen in mm (inch)

Rear Mounted

Standard, Rear Mounted

Standard, rückseitig montiert

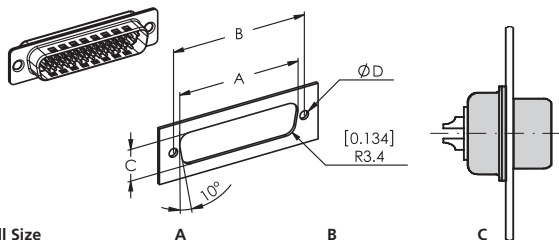

Shell Size	A	B	C
Gehäusegröße	±0,2 (±0.008)	±0,1 (±0.004)	±0,2 (±0.008)
1	20,5 (0.807)	25,0 (0.984)	11,4 (0.449)
2	28,8 (1.134)	33,3 (1.311)	11,4 (0.449)
3	42,5 (1.673)	47,0 (1.850)	11,4 (0.449)
4	59,1 (2.327)	63,5 (2.500)	11,4 (0.449)
5	56,3 (2.217)	61,1 (2.406)	14,1 (0.555)

Dimensions in mm (inch) - Abmessungen in mm (inch)

Electrical Data

Elektrische Daten

Electrical Data	
Elektrische Daten	
Current rating	3 A
Maximale Stromstärke	
Contact resistance	≤ 15 mΩ
Durchgangswiderstand	
Insulation resistance	≥ 3000 mΩ
Isolationswiderstand	
Test voltage	1000 V
Prüfspannung	
Operating temperature	-55 °C bis 105 °C (-67 °F to 221 °F)
Betriebstemperatur	

Montageausschnitt

Frontseitig montiert

Float, Front Mounted (Series FW)

Schwimmend, frontseitig montiert (Baureihe FW)

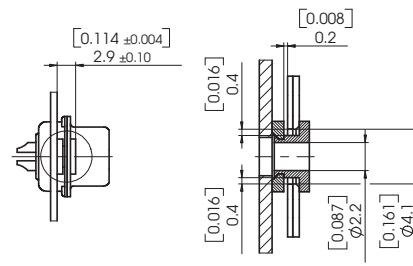

Shell Size	Mounting	Ø D
Gehäusegröße	Befestigung	±0,05 (±0.002)
1 - 5	Standard / Standard	3,1 (0.122)
1 - 5	Float mounted / schwimmend	2,2 (0.087)

Dimensions in mm (inch) - Abmessungen in mm (inch)

Rückseitig montiert

Float, Rear Mounted (Series FW)

Schwimmend, rückseitig montiert (Baureihe FW)

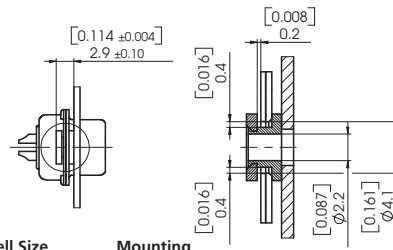

Shell Size	Mounting	Ø D
Gehäusegröße	Befestigung	±0,05 (±0.002)
1 - 5	Standard / Standard	3,1 (0.122)
1 - 5	float mounted / schwimmend	2,2 (0.087)

Dimensions in mm (inch) - Abmessungen in mm (inch)



X-ON Electronics

Largest Supplier of Electrical and Electronic Components

Click to view similar products for [D-Sub High Density Connectors](#) category:

Click to view products by [Molex](#) manufacturer:

Other Similar products are found below :

[97-3250-11](#) [163A16809X](#) [163A17089X](#) [164A17199X](#) [242A25680X](#) [L717HDB44POL2R210](#) [L717HDEH15POL2](#) [L777HDE15P](#)
[L77HDE15SC309](#) [163A16759X](#) [163A16839X](#) [163A16989X](#) [163A17079X](#) [164A17329X](#) [164A18219X](#) [241A16440X](#) [241A16550X](#)
[241A16680X](#) [241A20810X](#) [241A25740X](#) [CT25-44P](#) [MDBE15PE766](#) [L177HDE15SOL2RM23](#) [L177HRC62S](#) [L177HRC62SVFM](#)
[L177HRCG62S](#) [L717HDEG15POL2RM5](#) [L77HDA26SVF](#) [L77HDE15SD1CO](#) [L77HDEH15SOL2RM832](#) [DAMA-15S-WS](#) [443895-3](#)
[106698-1](#) [280-012K2C](#) [L177HRB44S](#) [164A17039X](#) [09562004701510](#) [164A17969X](#) [L777HRC62P](#) [241A17960X](#) [164A18269X](#) [280-](#)
[019S1S9MEN](#) [L777HDEG15P](#) [280-018P3S25MEGN](#) [206504-2](#) [40-9515HDSP](#) [2057140-1](#) [C115370-6002](#) [DFMA104SNMBFR172FR022](#)
[HDC9F200E2S](#)