

PLEASE CHECK WWW.MOLEX.COM FOR LATEST PART INFORMATION

Part Number: **0190020015**
Status: **Active**
Overview: Standard Quick-Disconnect Terminals
Description: Avikrimp Fully Insulated Quick Disconnect, Female, for 18-22 AWG Wire, Metal Strip

Documents:

[3D Model](#) [Product Specification PS-19902-011-001 \(PDF\)](#)
[3D Model \(PDF\)](#) [Product Specification PS-19902-014-001 \(PDF\)](#)
[Drawing \(PDF\)](#) [RoHS Certificate of Compliance \(PDF\)](#)

Agency Certification

CSA LR18689
 UL E79133

General

Product Family Quick Disconnects
 Series 19002
 Crimp Quality Equipment Yes
 Insulated Fully
 Overview Standard Quick-Disconnect Terminals
 Product Name Avikrimp
 Type Quick Disconnect
 UPC 800753027121

Physical

Barrel Type Closed
 Color - Resin Red
 Flammability 94V-2
 Gender Female
 Glow-Wire Capable No
 Insulation Nylon (PA)
 Lock to Mating Part None
 Material - Metal Brass
 Material - Plating Mating Tin
 Material - Plating Termination Tin
 Net Weight 0.695/g
 Orientation Straight
 Packaging Type Reel
 Plating min - Mating 4.064µm
 Plating min - Termination 4.064µm
 Polarized to Mating Part No
 Tab Thickness 0.51mm
 Tab Width 2.79mm
 Temperature Range - Operating -65° to +105°C
 Termination Interface: Style Crimp or Compression
 Wire Insulation Diameter 3.17mm max.
 Wire Size AWG 18, 20, 22

Electrical

Voltage - Maximum 300V

Solder Process Data

Lead-free Process Capability N/A

Material Info

Engineering Number AA-5275Z

Reference - Drawing Numbers

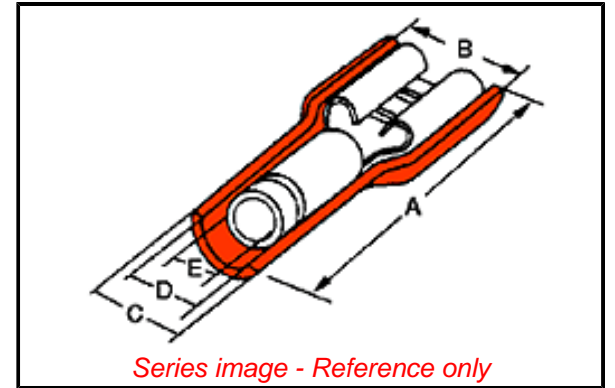

EU ELV

Not Relevant

EU RoHS

Compliant

REACH SVHC

Not Contained Per -
 D(2021)4569-DC (8
 July 2021)

Halogen-Free

Status

Low-Halogen

For more information, please visit [Contact US](#)

China ROHS

ELV

RoHS Phthalates

China RoHS

Green Image

Not Relevant

Not Contained

Search Parts in this Series

19002 Series

Application Tooling | FAQ

Tooling specifications and manuals are found by selecting the products below. Crimp Height Specifications are then contained in the Application Tooling Specification document.

Global

Description

Product #

Mini-Mac Applicator 638812000

This document was generated on 09/14/2021

PLEASE CHECK WWW.MOLEX.COM FOR LATEST PART INFORMATION

X-ON Electronics

Largest Supplier of Electrical and Electronic Components

Click to view similar products for [Terminals](#) category:

Click to view products by [Molex](#) manufacturer:

Other Similar products are found below :

[00-054007-01074-6](#) [00-054007-70206-1](#) [00-054007-70210-8](#) [00-054007-70217-7](#) [00-054007-70226-9](#) [00-054007-70228-3](#) [00-054007-70248-1](#) [00-054007-70256-6](#) [00-054007-70301-3](#) [00-054007-70316-7](#) [0-0320562-0](#) [00-054007-49560-4](#) [00-054007-70209-2](#) [00-054007-70225-2](#) [00-054007-70227-6](#) [00-054007-70231-3](#) [00-054007-70241-2](#) [00-054007-70242-9](#) [00-054007-70244-3](#) [00-054007-70246-7](#) [00-054007-70263-4](#) [00-054007-70288-7](#) [00-054007-70290-0](#) [00-054007-70300-6](#) [00-054007-70304-4](#) [01-2065-1-0216](#) [01-2900-1-04412](#) [00581P0075](#) [600TS-10](#) [60205-1](#) [604200-1](#) [605601-1](#) [60598-1-CUT-TAPE](#) [61314-6-C](#) [61810-3](#) [61-S](#) [62149-1](#) [626-0194](#) [62-NBM-A](#) [62-SN](#) [62-SP](#) [640179-1](#) [M55155/059I03](#) [M55155/079C01](#) [M55155/099H02](#) [M55155/109H01](#) [M55155/109H02](#) [M55155/12XH05](#) [M55155/16XH02](#) [M55155/29-5S](#)