

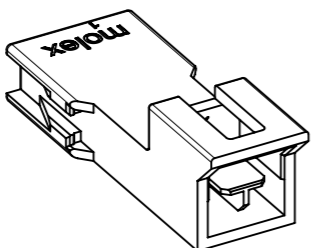

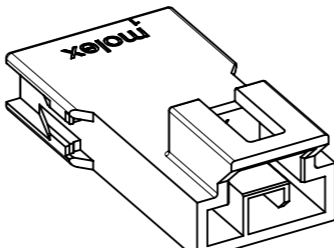

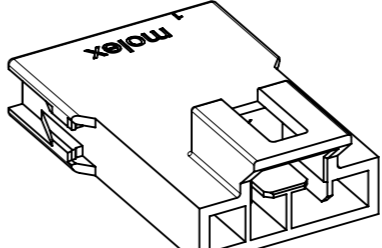

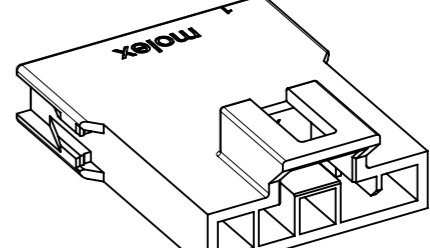

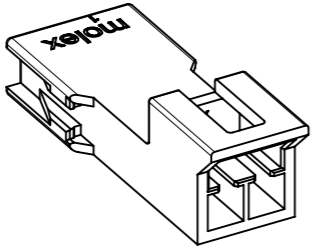
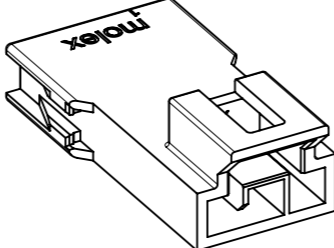
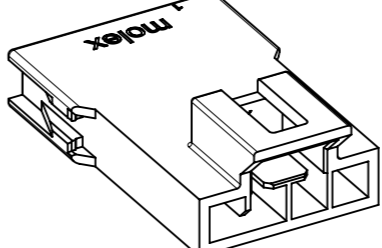
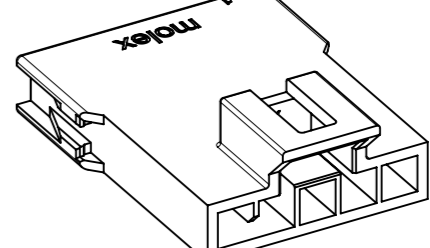
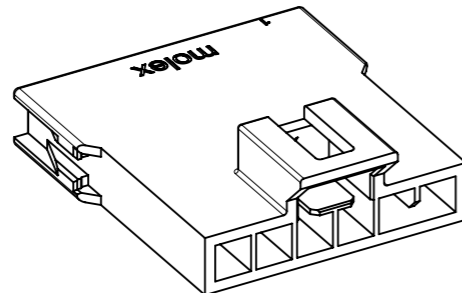
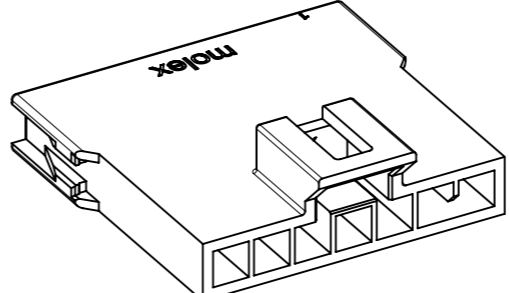
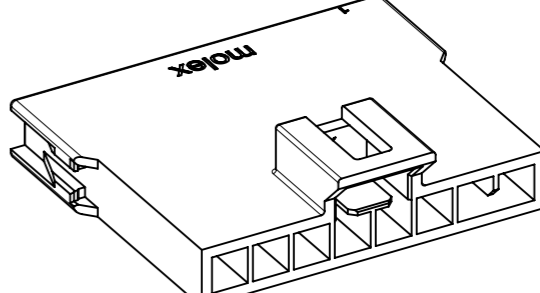
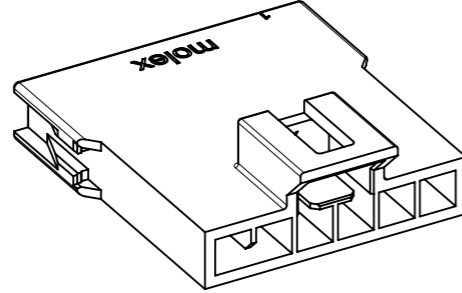
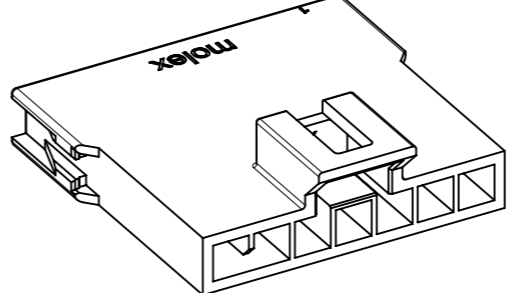
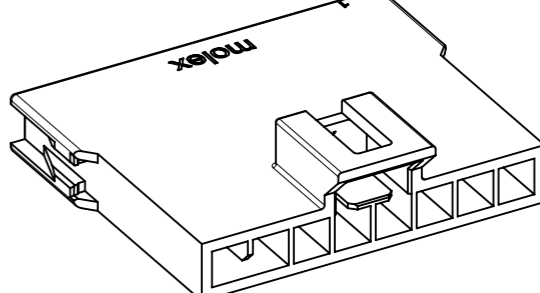

FREE HANGING PLUG PARTS

	2 CKT	3 CKT	4 CKT	5 CKT
BLACK				
NATURAL				
	6 CKT	7 CKT	8 CKT	
BLACK				
NATURAL				

SYMBOLS  = 0  = 0  = 0  = 0  = 0  = 0  = 0  = 0	THIS DRAWING CONTAINS INFORMATION THAT IS PROPRIETARY TO MOLEX ELECTRONIC TECHNOLOGIES, LLC AND SHOULD NOT BE USED WITHOUT WRITTEN PERMISSION DIMENSION UNITS: mm SCALE: 2.5:1		CURRENT REV DESC: EC NO: 615493 DRWN: GLLI 2019/03/06 CHK'D: AYIN 2019/04/17 APPR: AYIN 2019/04/17		 PLUG HOUSING OF NANO-FIT WTW SR POWER CONNECTOR
	GENERAL TOLERANCES (UNLESS SPECIFIED) ANGULAR TOL ± ° 4 PLACES ± 3 PLACES ± 2 PLACES ± 0.15 1 PLACE ± 0 PLACES ± DRAFT WHERE APPLICABLE MUST REMAIN WITHIN DIMENSIONS		INITIAL REVISION: DRWN: GLLI 2018/07/19 APPR: AYIN 2019/04/17		
DOCUMENT STATUS: P1 RELEASE DATE: 2019/04/17 03:17:25		THIRD ANGLE PROJECTION: 		DRAWING: A3-SIZE SERIES: 200277	MATERIAL NUMBER: SEE SHEET 2 CUSTOMER: GENERAL MARKET SHEET NUMBER: 3 OF 6

PANEL MOUNT PLUG PARTS

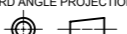
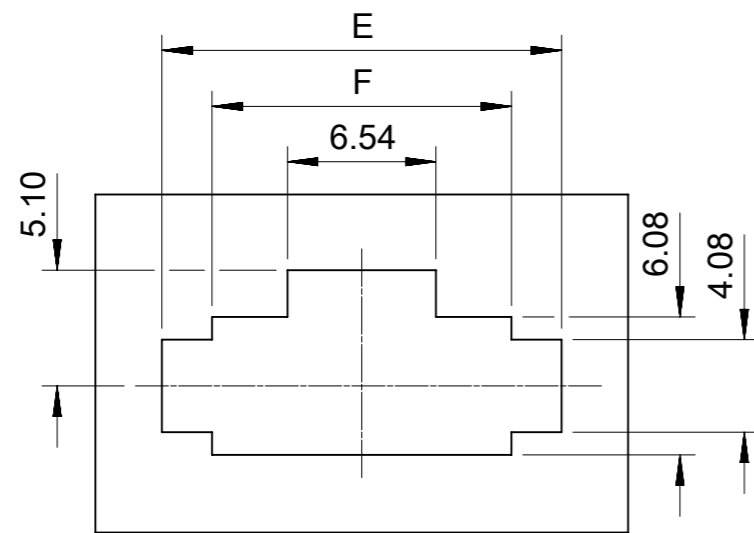
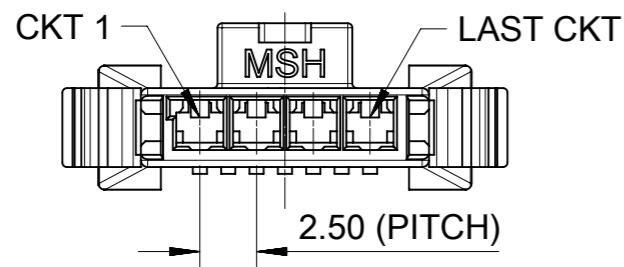
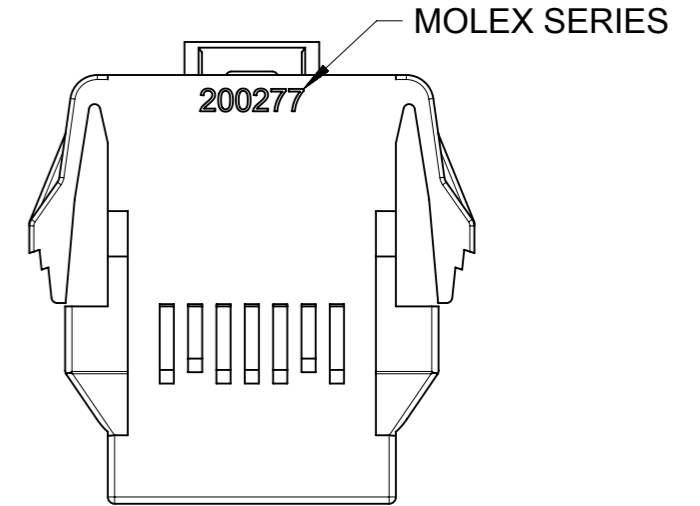
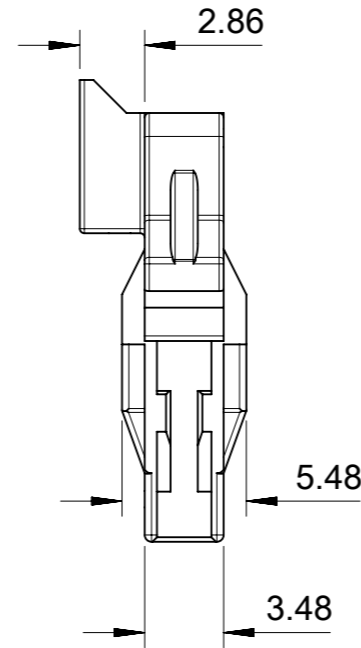
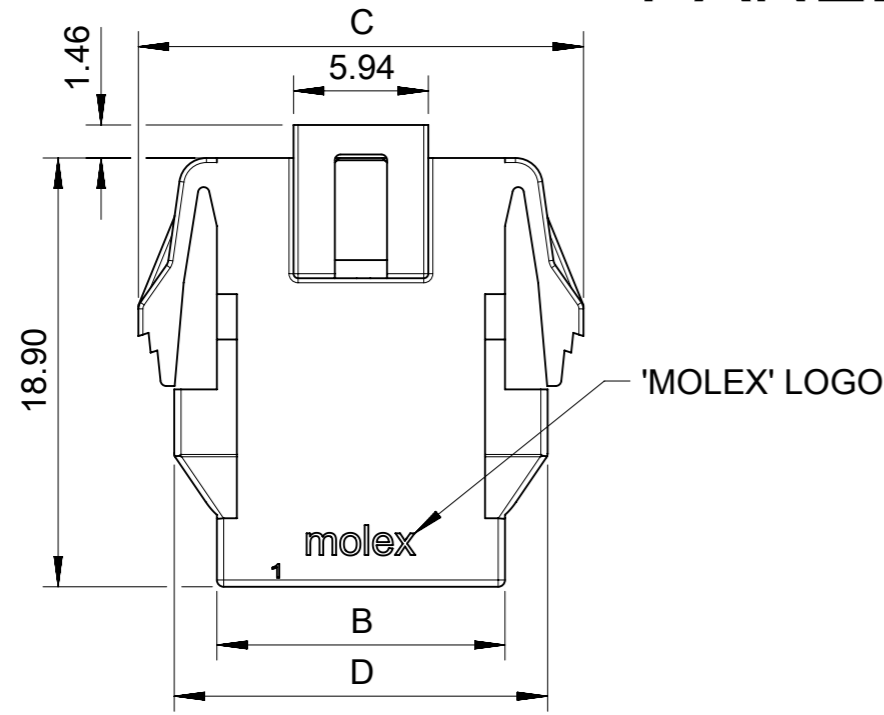

RECOMMENDED PANEL CUT OUT
(THICKNESS: 1.2~2.2MM)

COLOR FEATURE	
BLACK	NATURAL

SYMBOLS DIMENSION UNITS: mm SCALE: 3:1 GENERAL TOLERANCES (UNLESS SPECIFIED) ANGULAR TOL: ± ° 4 PLACES: ± 3 PLACES: ± 2 PLACES: ± 0.15 1 PLACE: ± 0 PLACES: ± DRAFT WHERE APPLICABLE MUST REMAIN WITHIN DIMENSIONS THIRD ANGLE PROJECTION	THIS DRAWING CONTAINS INFORMATION THAT IS PROPRIETARY TO MOLEX ELECTRONIC TECHNOLOGIES, LLC AND SHOULD NOT BE USED WITHOUT WRITTEN PERMISSION		CURRENT REV DESC: EC NO: 615493 DRWN: GLLI 2019/03/06 CHK'D: AYIN 2019/04/17 APPR: AYIN 2019/04/17		molex PLUG HOUSING OF NANO-FIT WTW SR POWER CONNECTOR	
	INITIAL REVISION: DRWN: GLLI 2018/07/19 APPR: AYIN 2019/04/17		PRODUCT CUSTOMER DRAWING			
	DOCUMENT NUMBER: 2002771000-SD DOC TYPE: PSD DOC PART: 000 REVISION: A		MATERIAL NUMBER: SEE SHEET 5 CUSTOMER: GENERAL MARKET		SHEET NUMBER: 4 OF 6	
	DRAWING: A3-SIZE SERIES: 200277		SHEET NUMBER: 4 OF 6			

X-ON Electronics

Largest Supplier of Electrical and Electronic Components

Click to view similar products for [Headers & Wire Housings](#) category:

Click to view products by [Molex](#) manufacturer:

Other Similar products are found below :

[892-18-020-10-001101](#) [58102-G61-06LF](#) [582553-1](#) [0009485154](#) [009176003701906](#) [0050291907](#) [LY20-4P-DT1-P1E-BR](#) [02.125.8002.8](#)
[609-3404](#) [61062-3](#) [622-0430](#) [622-3653LF](#) [63453-116](#) [636-1030](#) [636-1427](#) [636-3427](#) [636-4007](#) [641938-9](#) [641991-4](#) [644827-2](#) [65817-010LF](#)
[65817-015LF](#) [65863-015LF](#) [66207-023LF](#) [67095-007LF](#) [67601157](#) [68648-049](#) [70.362.1628.0](#) [70-4210](#) [70-4226B](#) [70-4853B](#) [707-5020](#) [707-](#)
[5028](#) [71.350.2428.0](#) [71918-208LF](#) [71961-016LF](#) [733-134](#) [733-162](#) [754199-000](#) [760-3052](#) [787-8014-00](#) [79531-3000](#) [FCN-360C032-B](#) [FCN-](#)
[367T-T012/H](#) [FCN-723D010/2](#) [80.063.4001.1](#) [800-90-001-10-001000](#) [800-90-010-10-002000](#) [801-43-002-10-013000](#) [801-43-006-10-002000](#)