

FREE HANGING PLUG PARTS

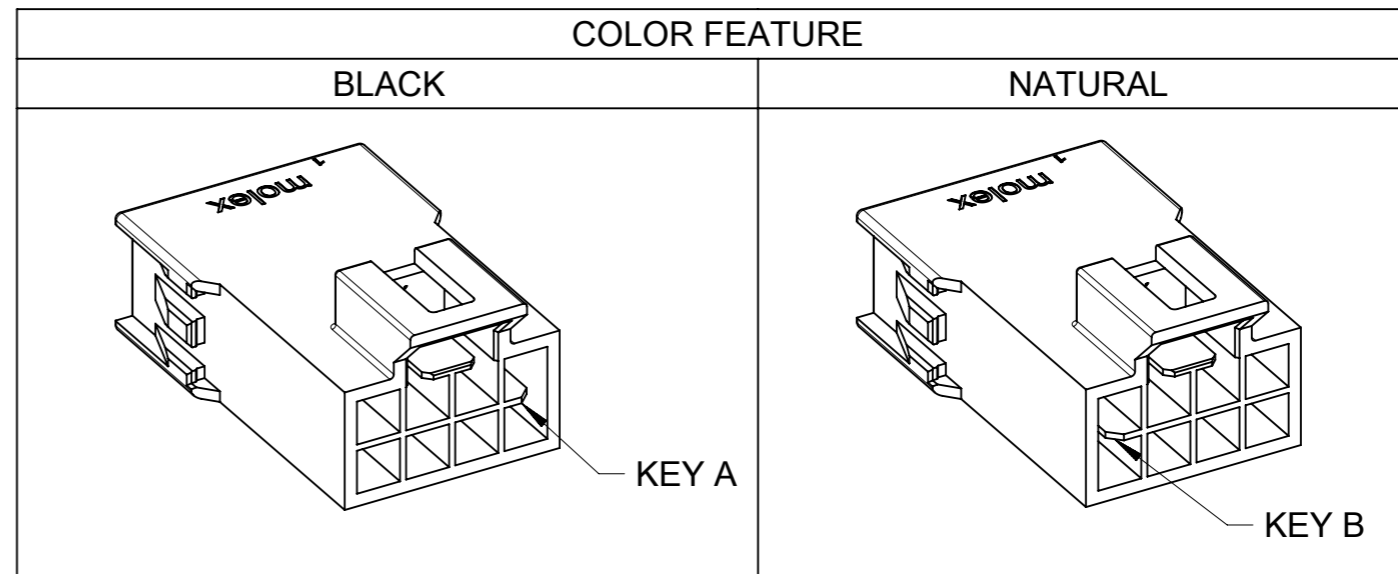
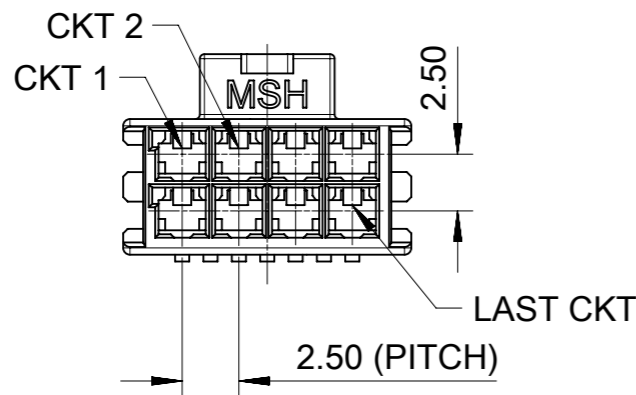
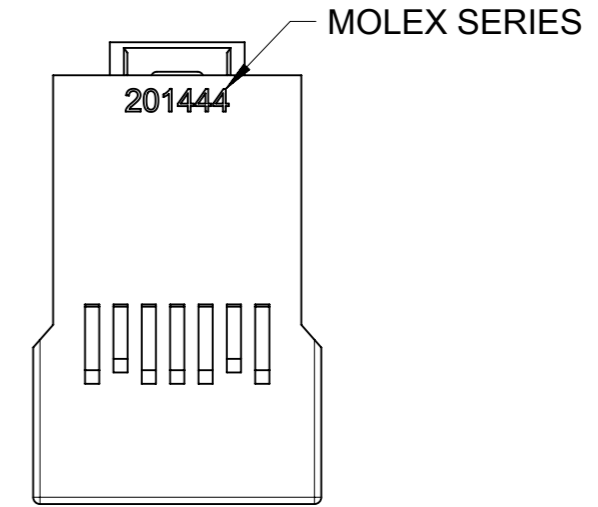
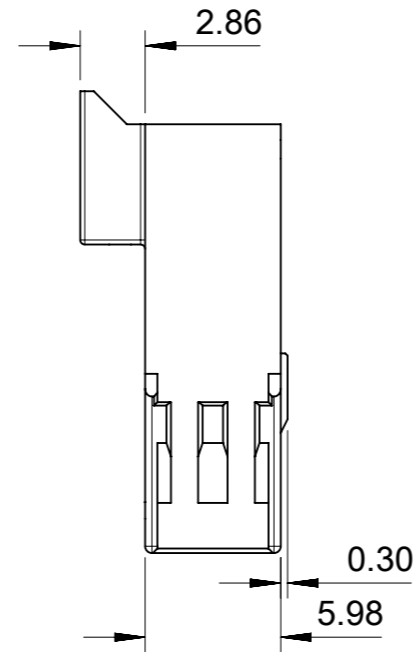
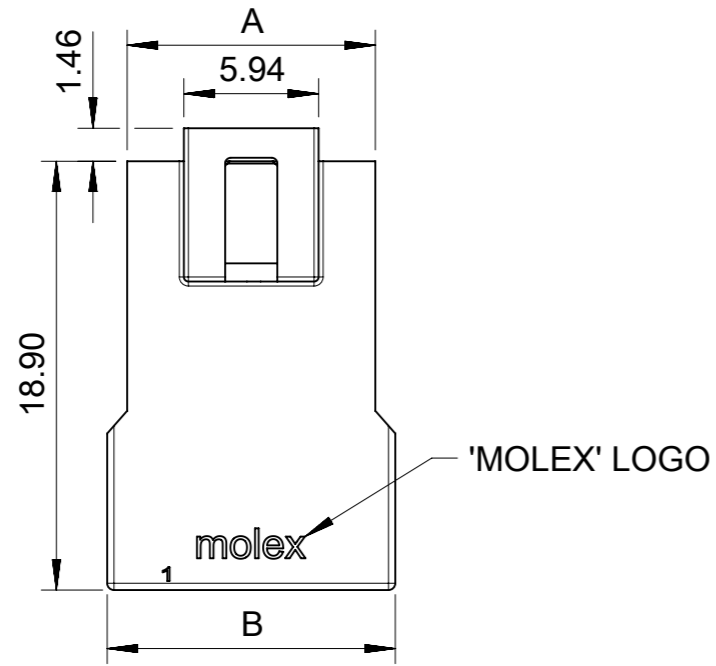

NOTES:

- MATERIAL:**
 OPTION 1: PA66, 94V-0, BLACK
 OPTION 2: PA66, 94V-0, NATURAL.
- PRODUCT SPECIFICATION:** 2014471000-PS.
- PACKAGE SPECIFICATION:** 2014441000-PK.
- THE COMPONENT COMPLIANT TO RoHS DIRECTIVE 2011/65/EU AND ELV DIRECTIVE 2000/53/EC.**
- TO MATE WITH TERMINAL OF 201447-****.**
TO MATE WITH TPA OF 105325-**.**
TO MATE WITH RECEPTACLE OF 105308-**.**
- PARTS CONFORM TO CLASS 'B' REQUIREMENTS OF COSMETIC SPECIFICATION PS-45499-002.**
- APPLICATION SPECIFICATION:** 201447-AS.

SYMBOLS		THIS DRAWING CONTAINS INFORMATION THAT IS PROPRIETARY TO MOLEX ELECTRONIC TECHNOLOGIES, LLC AND SHOULD NOT BE USED WITHOUT WRITTEN PERMISSION			
▽ = 0	mm	SCALE	3:1		
▽ = 0	GENERAL TOLERANCES (UNLESS SPECIFIED)		EC NO: 625349		2019/10/09 2019/10/10 2019/10/10
▽ = 0	ANGULAR TOL ± °		DRWN: GLLI		
▽ = 0	4 PLACES ±		CHK'D: YXZHENG		2018/07/19 2019/04/17
▽ = 0	3 PLACES ±		APPR: YXZHENG		
▽ = 0	2 PLACES ± 0.15		INITIAL REVISION:		2014441000-SD PSD 000 B
▽ = 0	1 PLACE ±		DRWN: GLLI		
▽ = 0	0 PLACES ±		APPR: AYIN		SEE SHEET 2 GENERAL MARKET 1 OF 6
▽ = 0	DRAFT WHERE APPLICABLE MUST REMAIN WITHIN DIMENSIONS		THIRD ANGLE PROJECTION	DRAWING	
▽ = 0				A3-SIZE	201444

FREE HANGING PLUG PARTS

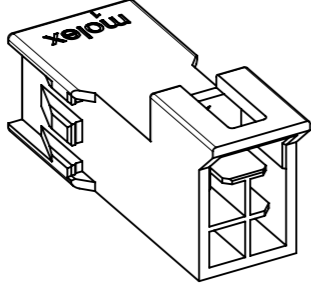
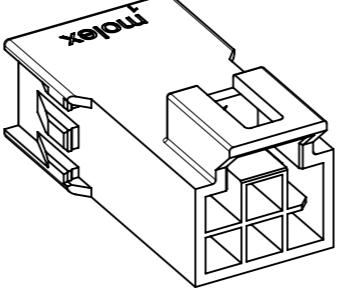
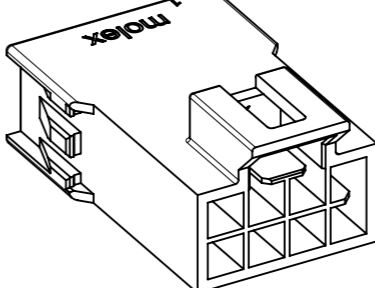
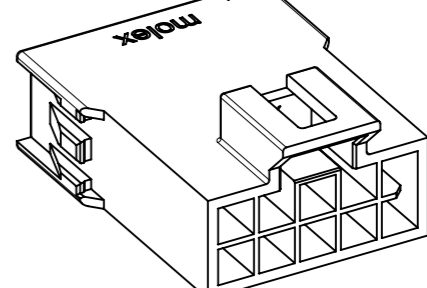
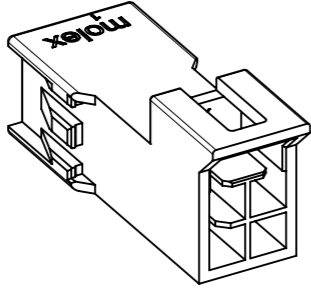
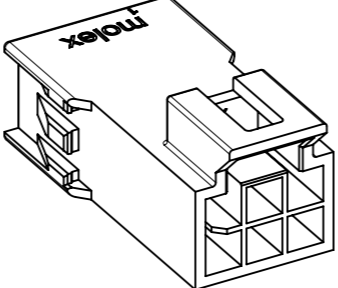
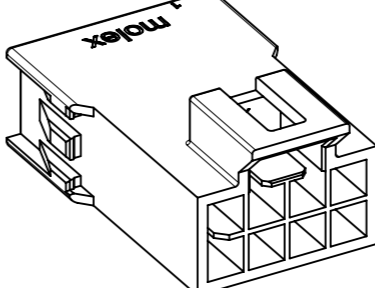
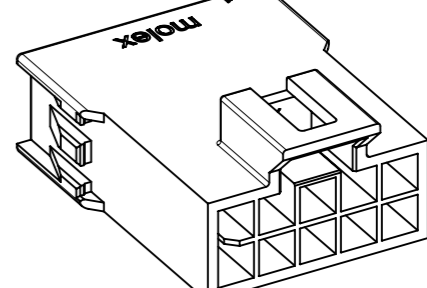
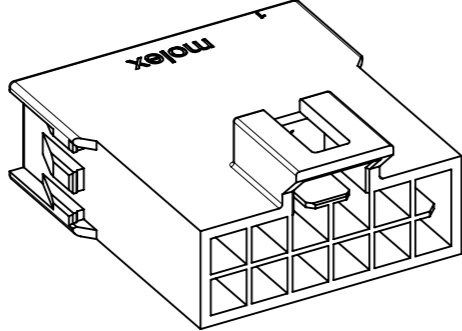
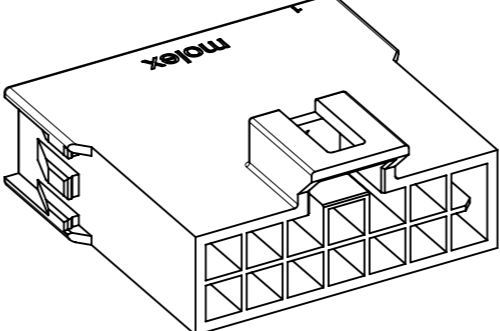
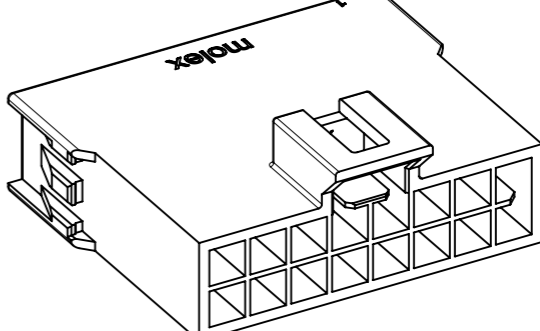
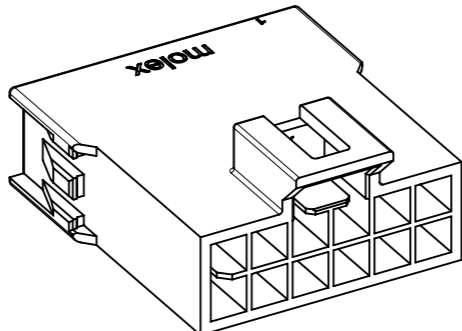
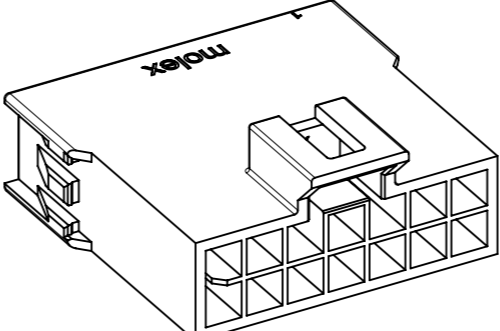
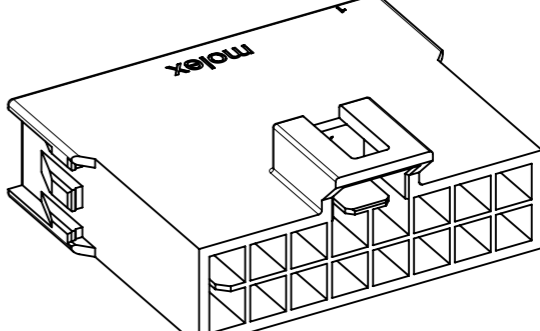
	4 CKT	6 CKT	8 CKT	10 CKT
BLACK				
NATURAL				
	12 CKT	14 CKT	16 CKT	
BLACK				
NATURAL				

SYMBOLS	THIS DRAWING CONTAINS INFORMATION THAT IS PROPRIETARY TO MOLEX ELECTRONIC TECHNOLOGIES, LLC AND SHOULD NOT BE USED WITHOUT WRITTEN PERMISSION		molex
	mm	SCALE 2.5:1	
▽ = 0	GENERAL TOLERANCES (UNLESS SPECIFIED)		PRODUCT CUSTOMER DRAWING
▽ = 0	ANGULAR TOL ± °		
▽ = 0	4 PLACES ±	EC NO: 625349	DOCUMENT NUMBER 2014441000-SD
▽ = 0	3 PLACES ±	DRWN: GLLI 2019/10/09	
▽ = 0	2 PLACES ± 0.15	CHK'D: YXZHENG 2019/10/10	
▽ = 0	1 PLACE ±	APPR: YXZHENG 2019/10/10	DOC TYPE DOC PART REVISION PSD 000 B
▽ = 0	0 PLACES ±	INITIAL REVISION:	MATERIAL NUMBER 201444
▽ = 0		DRWN: GLLI 2018/07/19	
▽ = 0		APPR: AYIN 2019/04/17	CUSTOMER GENERAL MARKET
▽ = 0	DRAFT WHERE APPLICABLE MUST REMAIN WITHIN DIMENSIONS	THIRD ANGLE PROJECTION	SHEET NUMBER 3 OF 6
▽ = 0		DRAWING A3-SIZE	SEE SHEET 2

PANEL MOUNT PLUG PARTS

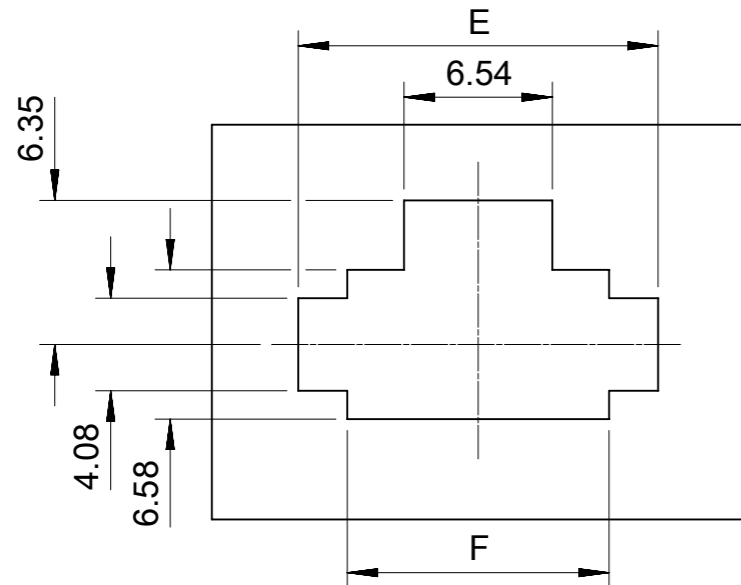
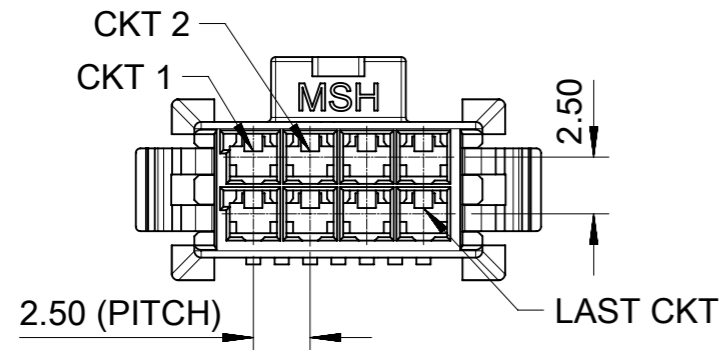
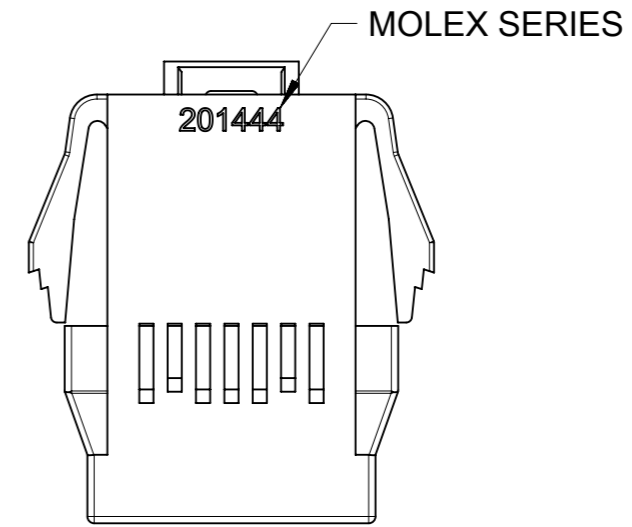
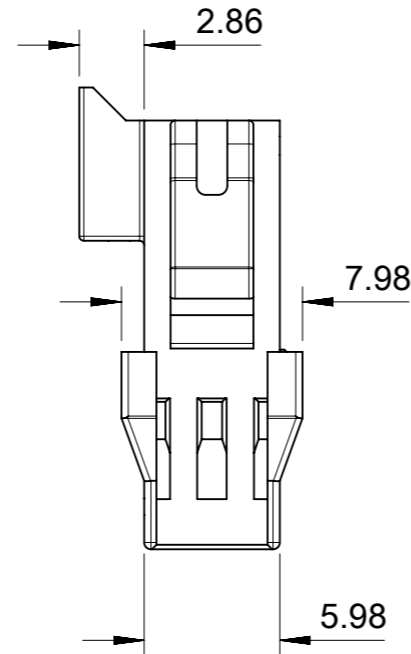
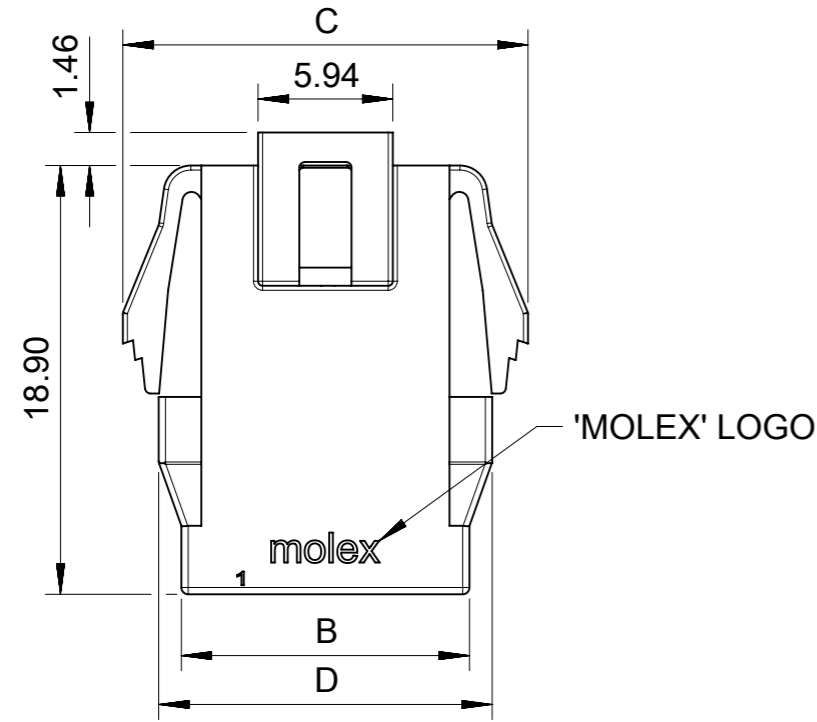

RECOMMENDED PANEL CUT OUT
(THICKNESS=1.2~2.2MM)

COLOR FEATURE	
BLACK	NATURAL
<p>KEY A</p>	<p>KEY B</p>

SYMBOLS DIMENSION UNITS: mm SCALE: 3:1 GENERAL TOLERANCES (UNLESS SPECIFIED): ANGULAR TOL: ± ° 4 PLACES: ± 3 PLACES: ± 2 PLACES: ± 0.15 1 PLACE: ± 0 PLACES: ± DRAFT WHERE APPLICABLE MUST REMAIN WITHIN DIMENSIONS THIRD ANGLE PROJECTION DRAWING: A3-SIZE SERIES: 201444	THIS DRAWING CONTAINS INFORMATION THAT IS PROPRIETARY TO MOLEX ELECTRONIC TECHNOLOGIES, LLC AND SHOULD NOT BE USED WITHOUT WRITTEN PERMISSION CURRENT REV DESC: EC NO: 625349 DRWN: GLLI 2019/10/09 CHK'D: YXZHENG 2019/10/10 APPR: YXZHENG 2019/10/10 INITIAL REVISION: DRWN: GLLI 2018/07/19 APPR: AYIN 2019/04/17			<p>PLUG HOUSING OF NANO-FIT WTW DR POWER CONNECTOR</p> <p>PRODUCT CUSTOMER DRAWING</p>		
	DOCUMENT NUMBER: 2014441000-SD DOC TYPE: PSD DOC PART: 000 REVISION: B					
	MATERIAL NUMBER: SEE SHEET 5 CUSTOMER: GENERAL MARKET SHEET NUMBER: 4 OF 6					

PANEL MOUNT PLUG PARTS

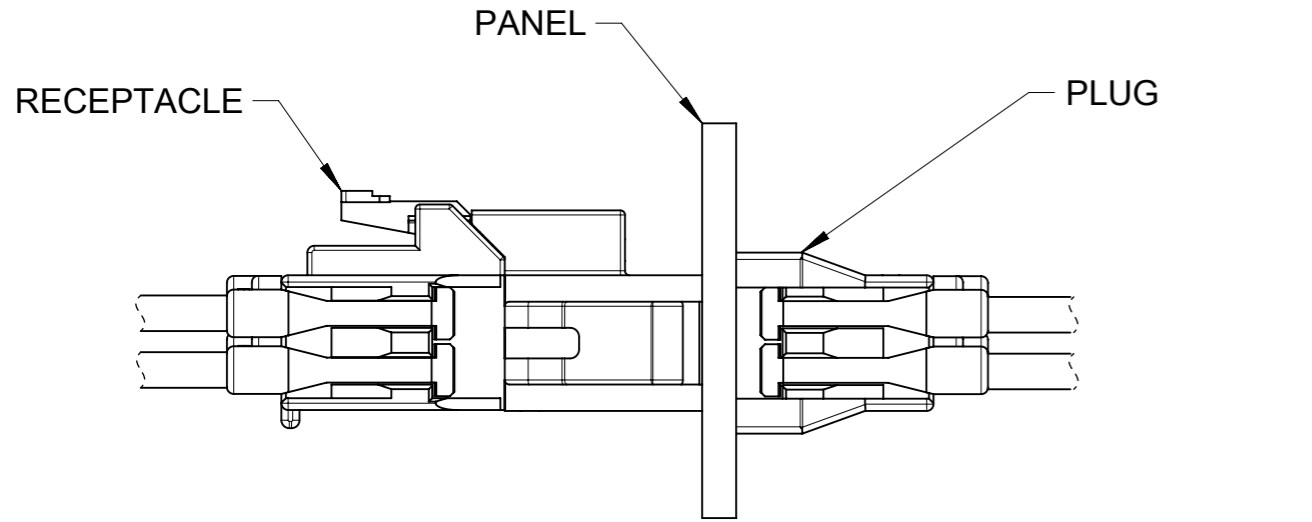

PART No	DIM'B'	DIM'C'	DIM'D'	DIM'E'	DIM'F'	CKT SIZE	COLOR
201444-1204	7.70	12.86	9.70	10.86	6.54	4	BLACK (KEY A)
201444-1206	10.20	15.36	12.20	13.36	9.04	6	
201444-1208	12.70	17.86	14.70	15.86	11.54	8	
201444-1210	15.20	20.36	17.20	18.36	14.04	10	
201444-1212	17.70	22.86	19.70	20.86	16.54	12	
201444-1214	20.20	25.36	22.20	23.36	19.04	14	
201444-1216	22.70	27.86	24.70	25.86	21.54	16	NATURAL (KEY B)
201444-2204	7.70	12.86	9.70	10.86	6.54	4	
201444-2206	10.20	15.36	12.20	13.36	9.04	6	
201444-2208	12.70	17.86	14.70	15.86	11.54	8	
201444-2210	15.20	20.36	17.20	18.36	14.04	10	
201444-2212	17.70	22.86	19.70	20.86	16.54	12	
201444-2214	20.20	25.36	22.20	23.36	19.04	14	
201444-2216	22.70	27.86	24.70	25.86	21.54	16	

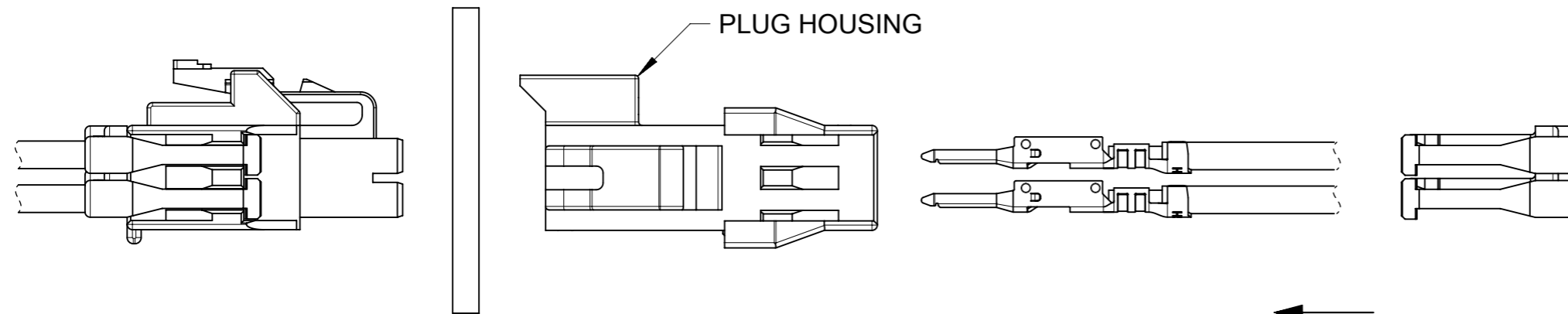







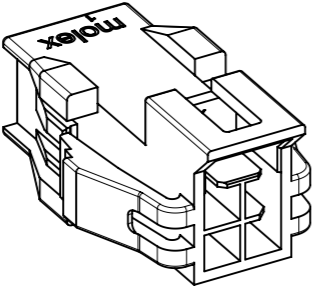
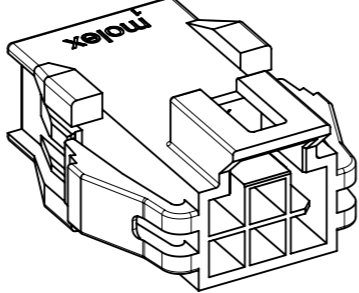
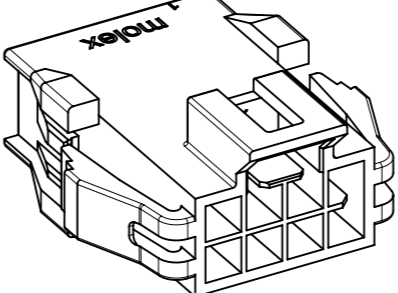
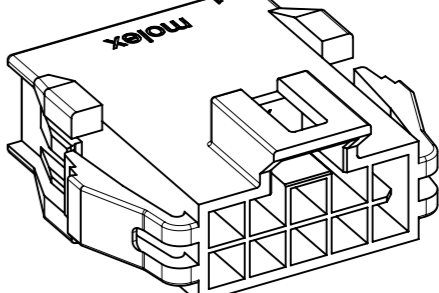
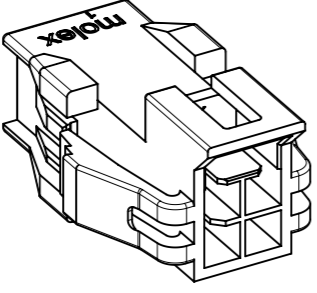
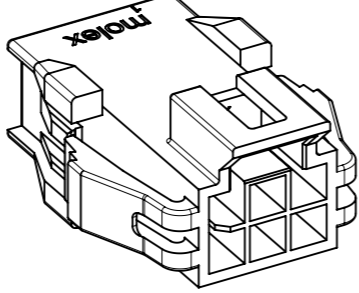
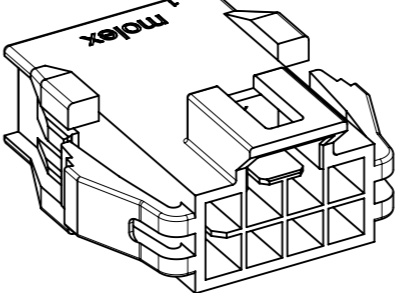
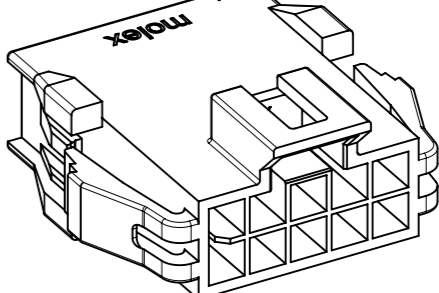
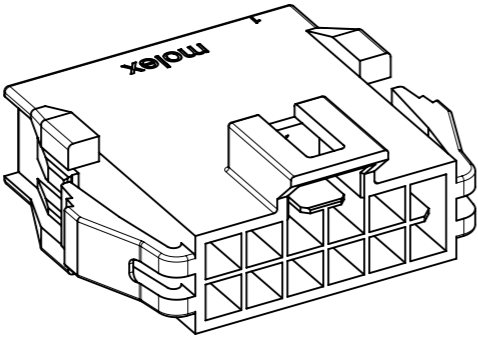
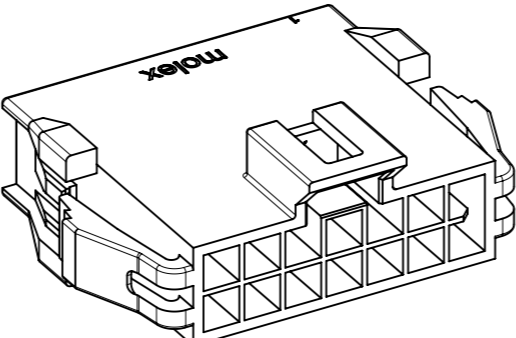
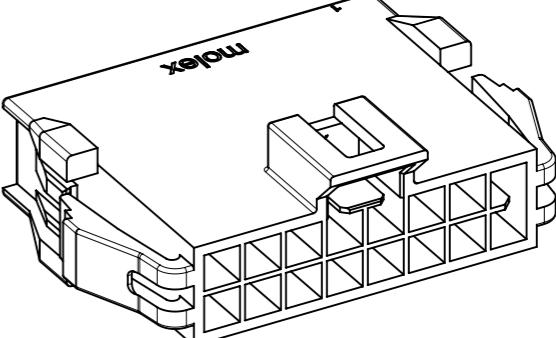
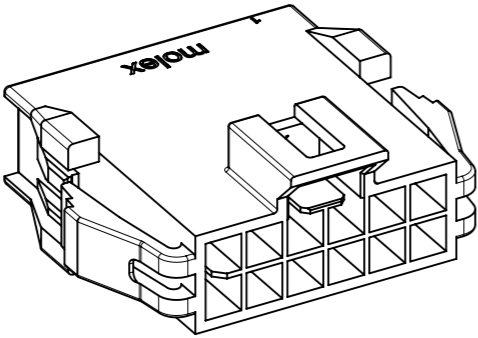
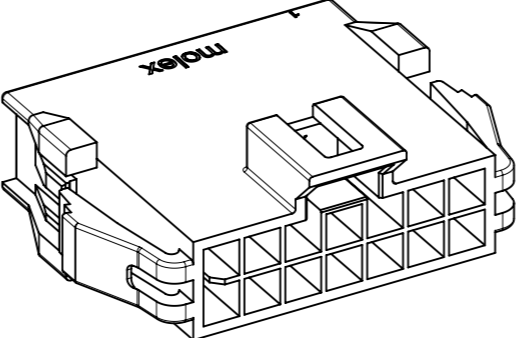
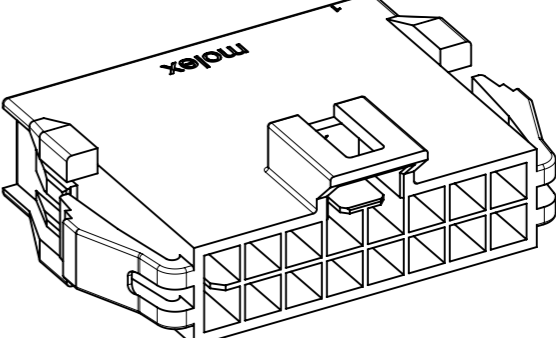

←
TERMINAL AND TPA ORIENTATION

SYMBOLS DIMENSION UNITS: mm SCALE: 3:1 GENERAL TOLERANCES (UNLESS SPECIFIED): ANGULAR TOL: ± ° 4 PLACES: ± 3 PLACES: ± 2 PLACES: ± 0.15 1 PLACE: ± 0 PLACES: ± DRAFT WHERE APPLICABLE MUST REMAIN WITHIN DIMENSIONS THIRD ANGLE PROJECTION:	THIS DRAWING CONTAINS INFORMATION THAT IS PROPRIETARY TO MOLEX ELECTRONIC TECHNOLOGIES, LLC AND SHOULD NOT BE USED WITHOUT WRITTEN PERMISSION CURRENT REV DESC: EC NO: 625349 DRWN: GLLI 2019/10/09 CHK'D: YXZHENG 2019/10/10 APPR: YXZHENG 2019/10/10 INITIAL REVISION: DRWN: GLLI 2018/07/19 APPR: AYIN 2019/04/17				
	PLUG HOUSING OF NANO-FIT WTW DR POWER CONNECTOR PRODUCT CUSTOMER DRAWING		DOCUMENT NUMBER: 2014441000-SD DOC TYPE: PSD DOC PART: 000 REVISION: B	MATERIAL NUMBER: SEE CHART CUSTOMER: GENERAL MARKET SHEET NUMBER: 5 OF 6	

PANEL MOUNT PLUG PARTS

	4 CKT	6 CKT	8 CKT	10 CKT
BLACK				
NATURAL				
	12 CKT	14 CKT	16 CKT	
BLACK				
NATURAL				

SYMBOLS  = 0  = 0  = 0  = 0  = 0  = 0  = 0	THIS DRAWING CONTAINS INFORMATION THAT IS PROPRIETARY TO MOLEX ELECTRONIC TECHNOLOGIES, LLC AND SHOULD NOT BE USED WITHOUT WRITTEN PERMISSION		CURRENT REV DESC: EC NO: 625349 DRWN: GLLI 2019/10/09 CHK'D: YXZHENG 2019/10/10 APPR: YXZHENG 2019/10/10		 PLUG HOUSING OF NANO-FIT WTW DR POWER CONNECTOR PRODUCT CUSTOMER DRAWING
	DIMENSION UNITS: mm SCALE: 2.5:1 GENERAL TOLERANCES (UNLESS SPECIFIED) ANGULAR TOL ± °	INITIAL REVISION: DRWN: GLLI 2018/07/19 APPR: AYIN 2019/04/17		DOCUMENT NUMBER: 2014441000-SD	
	4 PLACES ± 3 PLACES ± 2 PLACES ± 0.15 1 PLACE ± 0 PLACES ±	THIRD ANGLE PROJECTION 		DOC TYPE: PSD DOC PART: 000 REVISION: B	
	DRAFT WHERE APPLICABLE MUST REMAIN WITHIN DIMENSIONS	DRAWING: A3-SIZE	SERIES: 201444	MATERIAL NUMBER: SEE SHEET 5 CUSTOMER: GENERAL MARKET SHEET NUMBER: 6 OF 6	

X-ON Electronics

Largest Supplier of Electrical and Electronic Components

Click to view similar products for [Headers & Wire Housings](#) category:

Click to view products by [Molex](#) manufacturer:

Other Similar products are found below :

[892-18-020-10-001101](#) [58102-G61-06LF](#) [582553-1](#) [0009485154](#) [009176003701906](#) [0050291907](#) [LY20-4P-DT1-P1E-BR](#) [02.125.8002.8](#)
[609-3404](#) [61062-3](#) [622-0430](#) [622-3653LF](#) [63453-116](#) [636-1030](#) [636-1427](#) [636-3427](#) [636-4007](#) [641938-9](#) [641991-4](#) [644827-2](#) [65817-010LF](#)
[65817-015LF](#) [65863-015LF](#) [66207-023LF](#) [67095-007LF](#) [67601157](#) [68648-049](#) [70.362.1628.0](#) [70-4210](#) [70-4226B](#) [70-4853B](#) [707-5020](#) [707-](#)
[5028](#) [71.350.2428.0](#) [71918-208LF](#) [71961-016LF](#) [733-134](#) [733-162](#) [754199-000](#) [760-3052](#) [787-8014-00](#) [79531-3000](#) [FCN-360C032-B](#) [FCN-](#)
[367T-T012/H](#) [FCN-723D010/2](#) [80.063.4001.1](#) [800-90-001-10-001000](#) [800-90-010-10-002000](#) [801-43-002-10-013000](#) [801-43-006-10-002000](#)