

| NO. OF CKTS. | DIM. A                        | DIM. B                        |
|--------------|-------------------------------|-------------------------------|
| 1            | (2.44 ± .15)<br>.096 ± .006   | —                             |
| 2            | (4.98 ± .15)<br>.196 ± .006   | (2.54 ± .10)<br>.100 ± .004   |
| 3            | (7.52 ± .15)<br>.296 ± .006   | (5.08 ± .10)<br>.200 ± .004   |
| 4            | (10.06 ± .15)<br>.396 ± .006  | (7.62 ± .10)<br>.300 ± .004   |
| 5            | (12.60 ± .18)<br>.496 ± .007  | (10.16 ± .13)<br>.400 ± .005  |
| 6            | (15.14 ± .18)<br>.596 ± .007  | (12.70 ± .13)<br>.500 ± .005  |
| 7            | (17.68 ± .20)<br>.696 ± .008  | (15.24 ± .15)<br>.600 ± .006  |
| 8            | (20.22 ± .20)<br>.796 ± .008  | (17.78 ± .15)<br>.700 ± .006  |
| 9            | (22.76 ± .20)<br>.896 ± .008  | (20.32 ± .15)<br>.800 ± .006  |
| 10           | (25.30 ± .25)<br>.996 ± .010  | (22.86 ± .20)<br>.900 ± .008  |
| 11           | (27.84 ± .25)<br>1.096 ± .010 | (25.40 ± .20)<br>1.000 ± .008 |
| 12           | (30.38 ± .25)<br>1.196 ± .010 | (27.94 ± .20)<br>1.100 ± .008 |
| 13           | (32.92 ± .25)<br>1.296 ± .010 | (30.48 ± .20)<br>1.200 ± .008 |
| 14           | (35.46 ± .25)<br>1.396 ± .010 | (33.02 ± .20)<br>1.300 ± .008 |
| 15           | (38.00 ± .28)<br>1.496 ± .011 | (35.56 ± .23)<br>1.400 ± .009 |
| 16           | (40.54 ± .28)<br>1.596 ± .011 | (38.10 ± .23)<br>1.500 ± .009 |
| 17           | (43.08 ± .28)<br>1.696 ± .011 | (40.64 ± .23)<br>1.600 ± .009 |
| 18           | (45.62 ± .28)<br>1.796 ± .011 | (43.18 ± .23)<br>1.700 ± .009 |
| 19           | (48.16 ± .28)<br>1.896 ± .011 | (45.72 ± .23)<br>1.800 ± .009 |
| 20           | (50.70 ± .30)<br>1.996 ± .012 | (48.26 ± .25)<br>1.900 ± .010 |

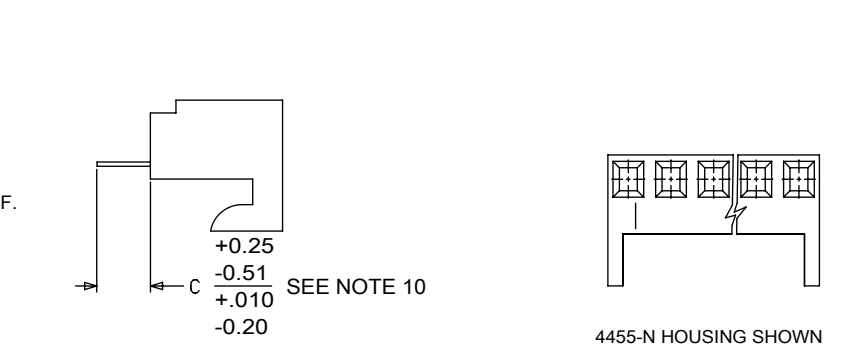

- NOTES:
- MATERIAL: NYLON, UL 94V-0, COLOR: WHITE
  - FINISH:
    - (208) - SELECT GOLD: (0.00038)/.000015 MIN., SELECT TIN: (0.00254)/.000100 MIN. OVERALL NICKEL UNDERPLATE: (0.00127)/.000050 MIN.
    - (228) - SELECT GOLD: (0.00076)/.000030 MIN., SELECT TIN: (0.00254)/.000100 MIN. OVERALL NICKEL UNDERPLATE: (0.00127)/.000050 MIN.
    - (231) - SELECT GOLD: (0.00127)/.000050 MIN., SELECT TIN: (0.00254)/.000100 MIN. OVERALL NICKEL UNDERPLATE: (0.00127)/.000050 MIN.
    - (565) - SELECT GOLD: (0.00051)/.000020 MIN., OVERALL NICKEL: (0.00076)/.000030 MIN. OVERALL GOLD FLASH: (0.00005)/.000002 MIN.
    - (P909) - OVERALL TIN: (0.00254)/.000100 MIN.
  - PARTS CONFORM TO PRODUCT SPECIFICATION PS-10-07.
  - PACKAGING: SEE CHARTS.
  - PARTS MUST CONFORM TO SOLDERABILITY SPEC 152.
  - PARTS ARE STACKABLE END TO END ON (2.54)/.100 CENTERS.
  - TYPICAL PCB THICKNESS: (1.57)/.062
  - PART CONFORMS TO CLASS B REQUIREMENTS OF COSMETIC SPECIFICATION PS-45499-002 EXCEPT PROTRUSIONS. PARTS MAY HAVE MORE THAN 2 GATE MARKS.
  - WHEN MATING ASSEMBLIES THAT USE 4455-BN HOUSINGS TO BREAKAWAY FRICTION LOCK OR POLARIZING HEADERS, THE END BACKWALLS MUST BE REMOVED.
  - DIMENSION C MEASURED WITH TERMINAL PUSHED IN AGAINST THE STOP.

|                 |    |              |            |          |
|-----------------|----|--------------|------------|----------|
| DOCUMENT STATUS | P1 | RELEASE DATE | 2020/03/04 | 11:31:57 |
|-----------------|----|--------------|------------|----------|

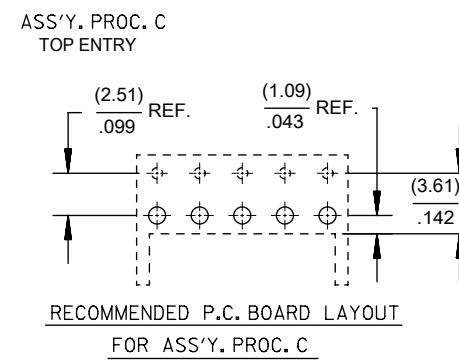
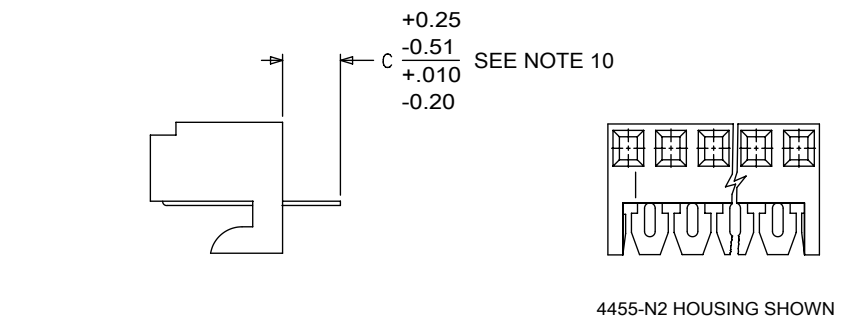
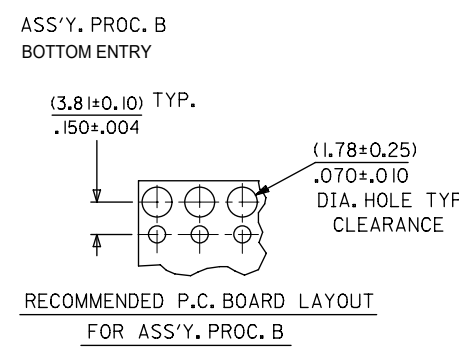
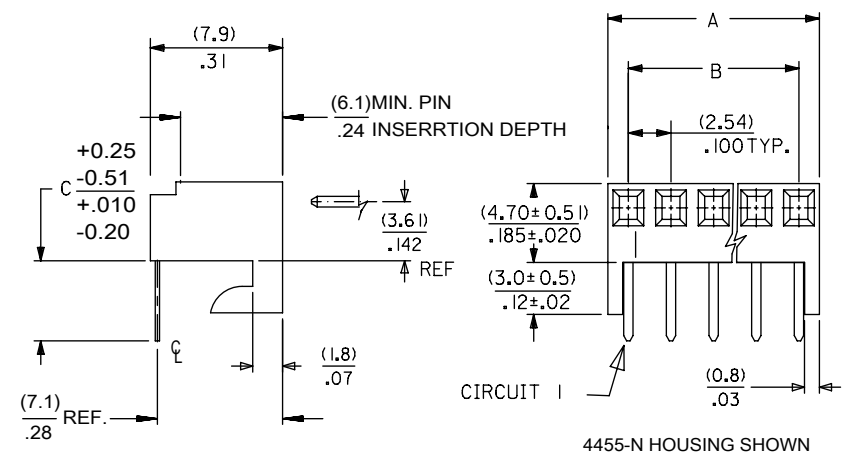
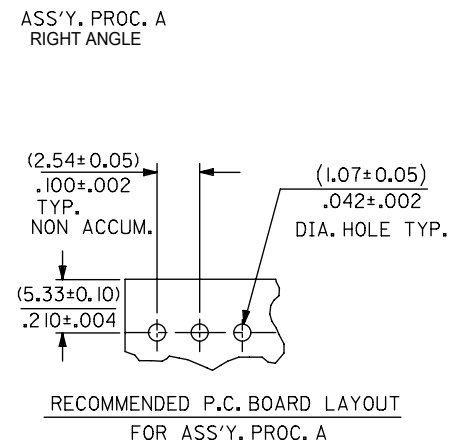
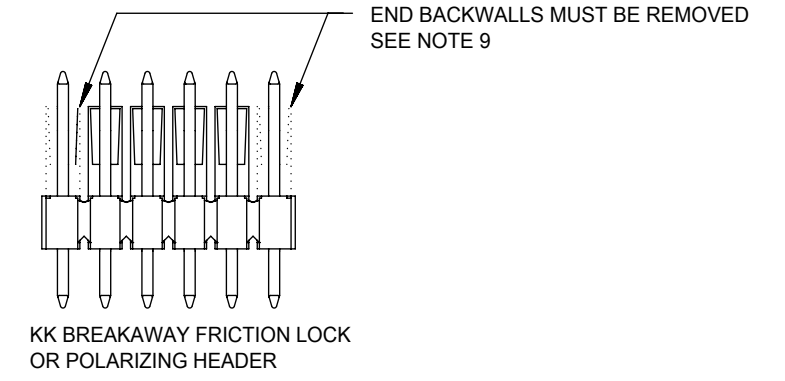
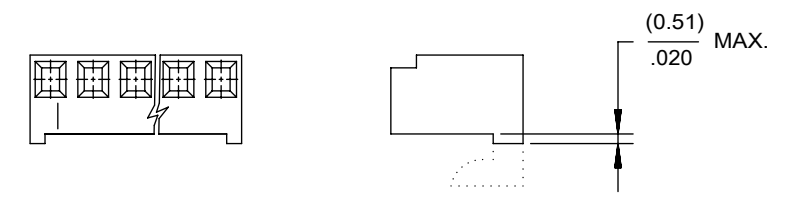
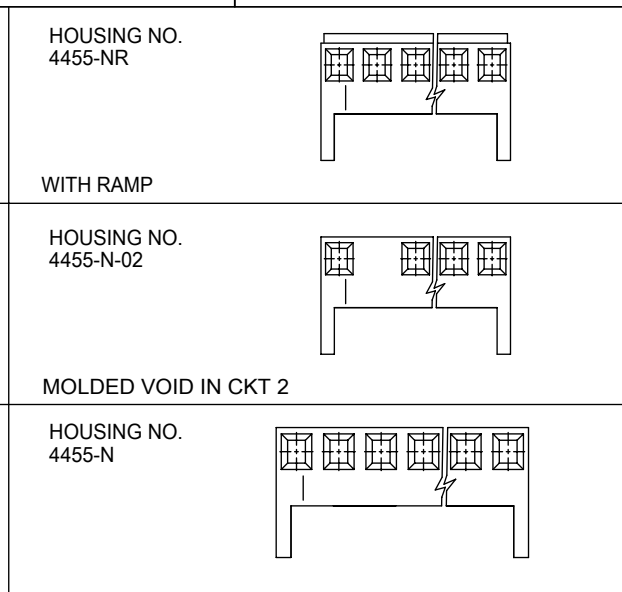
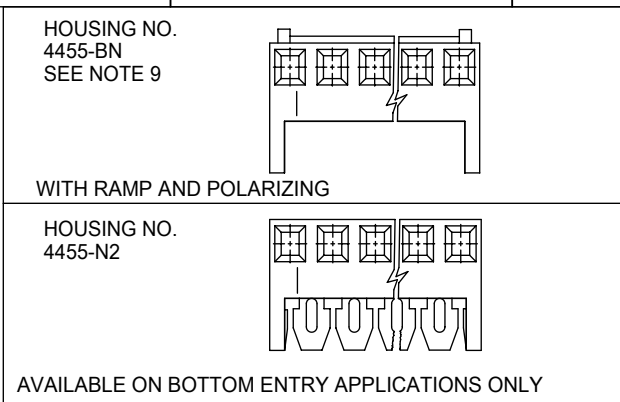

|         |  |   |                                       |   |                 |
|---------|--|---|---------------------------------------|---|-----------------|
| SYMBOLS |  | THIS DRAWING CONTAINS INFORMATION THAT IS PROPRIETARY TO MOLEX ELECTRONIC TECHNOLOGIES, LLC AND SHOULD NOT BE USED WITHOUT WRITTEN PERMISSION |                                       | CURRENT REV DESC: ADDED NEW PN 22022031 |                 |
| ▽ = 0   | DIMENSION UNITS                                      | SCALE   | GENERAL TOLERANCES (UNLESS SPECIFIED) |   |                 |
| ▽ = 0   | MM/IN  | 1:1   | 4 PLACES ± .01                        |   |                 |
| ▽ = 0   |  |   | 3 PLACES ± .01                        |   |                 |
| ▽ = 0   |  |   | 2 PLACES ± 0.25 ± 0.015               |   |                 |
| ▽ = 0   |  |   | 1 PLACE ± 0.36 ± .01                  |   |                 |
| ▽ = 0   |  |   | 0 PLACES ± .01                        |   |                 |
| ▽ = 0   | ANGULAR TOL  | ± 0.5°  | INITIAL REVISION:                     |   |                 |
| ▽ = 0   | DRAFT WHERE APPLICABLE MUST REMAIN WITHIN DIMENSIONS | THIRD ANGLE PROJECTION  | DRAWING                               | SERIES                                  | MATERIAL NUMBER |
| ▽ = 0   |  |   | B-SIZE                                | 4455                                    | SEE CHART       |
| 2-*     |  | D14   | PRODUCT CUSTOMER DRAWING              |   |                 |
| 1       |  | D17   | KK 100 PCB ASSY 4455 SERIES DWG       |   |                 |
| SHT.    |  | REV.  | DOCUMENT NUMBER                       |   |                 |
|         |  |   | SDA-4455                              |   |                 |
|         |  |   | PSD                                   | 001                                     | D17             |
|         |  |   | CUSTOMER                              | SHEET NUMBER                            |                 |
|         |  |   | GENERAL MARKET                        | 1 OF 1                                  |                 |



# KK 100 PCB ASSY 2-25 CKT

## 4455 SERIES

STANDARD PRODUCT

**ASSY PROCEDURE**  
 A=RIGHT ANGLE  
 B=BOTTOM ENTRY  
 C=TOP ENTRY

**HOUSING OPTION**  
 A=4455-AN  
 B=4455-BN  
 E=4455-NHH  
 G=4455-BN (HOOKS CUT OFF)  
 H=4455-N2 (BOTTOM ENTRY ONLY)  
 P=4455-NR (HOOKS CUT OFF)  
 R=4455-NR  
 V=4455-N-02  
 W=4455-N-02 (HOOKS CUT OFF)  
 Y=4455-N (HOOKS CUT OFF)  
 Z=4455-N

**NO OF CIRCUITS** \_\_\_\_\_

**TERMINAL TYPE**

| Code | Number  | Material    | Form        |
|------|---------|-------------|-------------|
| A    | 4316-4  | Brass       | Standard    |
| B    | 6516-4  | Phos Bronze | Standard    |
| C    | 6516-5C | Phos Bronze | Cat Ear / V |
| D    | 4316-3B | Brass       | Std / V     |
| F    | 6516-6C | Phos Bronze | Cat Ear / V |
| G    | 4316-3  | Brass       | Standard    |
| J    | 6516-3B | Phos Bronze | Std / V     |
| L    | 6516-3C | Phos Bronze | Cat Ear / V |
| M    | 6516-4A | Phos Bronze | Cat Ear     |
| T    | 4316-4A | Brass       | Cat Ear     |

**PLATING**  
 (SEE SHEET 1)



|              |              |
|--------------|--------------|
| Assy Proc:   | RIGHT ANGLE  |
| Hooks Cut:   | NO           |
| Housing No:  | 4455-N       |
| Terminal No: | 4316-4(P909) |
| Dim C:       | 3.35 / .132  |
| Plating:     | P909         |
| Packaging:   | PK-44646-001 |
| Voids:       | NONE         |

|              |              |
|--------------|--------------|
| Assy Proc:   | RIGHT ANGLE  |
| Hooks Cut:   | NO           |
| Housing No:  | 4455-N       |
| Terminal No: | 4316-4(565)  |
| Dim C:       | 3.35 / .132  |
| Plating:     | 565          |
| Packaging:   | PK-44646-001 |
| Voids:       | NONE         |

| Ckts | Material No | Engineer Number    | Material No | Engineer Number   |
|------|-------------|--------------------|-------------|-------------------|
| 2    | 22-15-2026  | A-4455-AZ02A(P909) | 22-16-2021  | A-4455-AZ02A(565) |
| 3    | 22-15-2036  | A-4455-AZ03A(P909) | 22-16-2031  | A-4455-AZ03A(565) |
| 4    | 22-15-2046  | A-4455-AZ04A(P909) | 22-16-2041  | A-4455-AZ04A(565) |
| 5    | 22-15-2056  | A-4455-AZ05A(P909) | 22-16-2051  | A-4455-AZ05A(565) |
| 6    | 22-15-2066  | A-4455-AZ06A(P909) | 22-16-2061  | A-4455-AZ06A(565) |
| 7    | 22-15-2076  | A-4455-AZ07A(P909) | 22-16-2071  | A-4455-AZ07A(565) |
| 8    | 22-15-2086  | A-4455-AZ08A(P909) | 22-16-2081  | A-4455-AZ08A(565) |
| 9    | 22-15-2096  | A-4455-AZ09A(P909) | 22-16-2091  | A-4455-AZ09A(565) |
| 10   | 22-15-2106  | A-4455-AZ10A(P909) | 22-16-2101  | A-4455-AZ10A(565) |
| 11   | 22-15-2116  | A-4455-AZ11A(P909) | 22-16-2111  | A-4455-AZ11A(565) |
| 12   | 22-15-2126  | A-4455-AZ12A(P909) | 22-16-2121  | A-4455-AZ12A(565) |
| 13   | 22-15-2136  | A-4455-AZ13A(P909) | 22-16-2131  | A-4455-AZ13A(565) |
| 14   | 22-15-2146  | A-4455-AZ14A(P909) | 22-16-2141  | A-4455-AZ14A(565) |
| 15   | 22-15-2156  | A-4455-AZ15A(P909) | 22-16-2151  | A-4455-AZ15A(565) |
| 16   | 22-15-2166  | A-4455-AZ16A(P909) | 22-16-2161  | A-4455-AZ16A(565) |
| 17   | 22-15-2176  | A-4455-AZ17A(P909) | 22-16-2171  | A-4455-AZ17A(565) |
| 18   | 22-15-2186  | A-4455-AZ18A(P909) | 22-16-2181  | A-4455-AZ18A(565) |
| 19   | 22-15-2196  | A-4455-AZ19A(P909) | 22-16-2191  | A-4455-AZ19A(565) |
| 20   | 22-15-2206  | A-4455-AZ20A(P909) | 22-16-2201  | A-4455-AZ20A(565) |
| 21   | 22-15-2216  | A-4455-AZ21A(P909) | 22-16-2211  | A-4455-AZ21A(565) |
| 22   | 22-15-2226  | A-4455-AZ22A(P909) | 22-16-2221  | A-4455-AZ22A(565) |
| 23   | 22-15-2236  | A-4455-AZ23A(P909) | 22-16-2231  | A-4455-AZ23A(565) |
| 24   | 22-15-2246  | A-4455-AZ24A(P909) | 22-16-2241  | A-4455-AZ24A(565) |
| 25   | 22-15-2256  | A-4455-AZ25A(P909) | 22-16-2251  | A-4455-AZ25A(565) |

|  |   |   |                                   |
|--|---|---|-----------------------------------|
| REV:<br><b>D14</b>                         | <b>ECR/ECN INFORMATION:</b><br>EC No.:<br>DATE: <b>3/4/2020</b> | <b>TITLE:</b><br><h2 style="text-align: center;">KK 100 PCB ASSY<br/>4455 SERIES DWG</h2> | <b>SHEET No.</b><br><b>- 2 -</b>  |
| <b>DOCUMENT NUMBER:</b><br><b>SDA-4455</b> |   | <b>CREATED / REVISED BY:</b><br><b>SS06</b>   | <b>CHECKED BY:</b><br><b>SS06</b> |
|  |   | <b>APPROVED BY:</b><br><b>ISHWARG</b>   |                                   |



# KK 100 PCB ASSY 2-25 CKT

## 4455 SERIES

STANDARD PRODUCT

| Ckts | RIGHT ANGLE  |                     | BOTTOM ENTRY |                      | BOTTOM ENTRY |                     | BOTTOM ENTRY |                     |
|------|--------------|---------------------|--------------|----------------------|--------------|---------------------|--------------|---------------------|
|      | Assy Proc:   | RIGHT ANGLE         | Assy Proc:   | BOTTOM ENTRY         | Assy Proc:   | BOTTOM ENTRY        | Assy Proc:   | BOTTOM ENTRY        |
|      | Hooks Cut:   | NO                  | Hooks Cut:   | NO                   | Hooks Cut:   | NO                  | Hooks Cut:   | NO                  |
|      | Housing No:  | 4455-N              | Housing No:  | 4455-N2              | Housing No:  | 4455-N2             | Housing No:  | 4455-N2             |
|      | Terminal No: | 4316-4(208)         | Terminal No: | 4316-3B(P909)        | Terminal No: | 4316-3B(565)        | Terminal No: | 4316-3B(208)        |
|      | Dim C:       | 3.35 / .132         | Dim C:       | 3.35 / .132          | Dim C:       | 3.35 / .132         | Dim C:       | 3.35 / .132         |
|      | Plating:     | 208                 | Plating:     | P909                 | Plating:     | 565                 | Plating:     | 208                 |
|      | Packaging:   | PK-44646-001        | Packaging:   | PK-44646-001         | Packaging:   | PK-44646-001        | Packaging:   | PK-44646-001        |
|      | Voids:       | NONE                | Voids:       | NONE                 | Voids:       | NONE                | Voids:       | NONE                |
|      |              |                     |              |                      |              |                     |              |                     |
|      | Material No  | Engineer Number     | Material No  | Engineer Number      | Material No  | Engineer Number     | Material No  | Engineer Number     |
| 2    | 22-16-2020   | A-4455-AZ02A(208)   | 22-14-2024   | A-4455-BH02D(P909)   | 22-17-2022   | A-4455-BH02D(565)   | 22-17-3022   | A-4455-BH02D(208)   |
| 3    | 22-16-2030   | A-4455-AZ 03 A(208) | 22-14-2034   | A-4455-BH 03 D(P909) | 22-17-2032   | A-4455-BH 03 D(565) | 22-17-3032   | A-4455-BH 03 D(208) |
| 4    | 22-16-2040   | A-4455-AZ 04 A(208) | 22-14-2044   | A-4455-BH 04 D(P909) | 22-17-2042   | A-4455-BH 04 D(565) | 22-17-3042   | A-4455-BH 04 D(208) |
| 5    | 22-16-2050   | A-4455-AZ 05 A(208) | 22-14-2054   | A-4455-BH 05 D(P909) | 22-17-2052   | A-4455-BH 05 D(565) | 22-17-3052   | A-4455-BH 05 D(208) |
| 6    | 22-16-2060   | A-4455-AZ 06 A(208) | 22-14-2064   | A-4455-BH 06 D(P909) | 22-17-2062   | A-4455-BH 06 D(565) | 22-17-3062   | A-4455-BH 06 D(208) |
| 7    | 22-16-2070   | A-4455-AZ 07 A(208) | 22-14-2074   | A-4455-BH 07 D(P909) | 22-17-2072   | A-4455-BH 07 D(565) | 22-17-3072   | A-4455-BH 07 D(208) |
| 8    | 22-16-2080   | A-4455-AZ 08 A(208) | 22-14-2084   | A-4455-BH 08 D(P909) | 22-17-2082   | A-4455-BH 08 D(565) | 22-17-3082   | A-4455-BH 08 D(208) |
| 9    | 22-16-2090   | A-4455-AZ 09 A(208) | 22-14-2094   | A-4455-BH 09 D(P909) | 22-17-2092   | A-4455-BH 09 D(565) | 22-17-3092   | A-4455-BH 09 D(208) |
| 10   | 22-16-2100   | A-4455-AZ 10 A(208) | 22-14-2104   | A-4455-BH 10 D(P909) | 22-17-2102   | A-4455-BH 10 D(565) | 22-17-3102   | A-4455-BH 10 D(208) |
| 11   | 22-16-2110   | A-4455-AZ 11 A(208) | 22-14-2114   | A-4455-BH 11 D(P909) | 22-17-2112   | A-4455-BH 11 D(565) | 22-17-3112   | A-4455-BH 11 D(208) |
| 12   | 22-16-2120   | A-4455-AZ 12 A(208) | 22-14-2124   | A-4455-BH 12 D(P909) | 22-17-2122   | A-4455-BH 12 D(565) | 22-17-3122   | A-4455-BH 12 D(208) |
| 13   | 22-16-2130   | A-4455-AZ 13 A(208) | 22-14-2134   | A-4455-BH 13 D(P909) | 22-17-2132   | A-4455-BH 13 D(565) | 22-17-3132   | A-4455-BH 13 D(208) |
| 14   | 22-16-2140   | A-4455-AZ 14 A(208) | 22-14-2144   | A-4455-BH 14 D(P909) | 22-17-2142   | A-4455-BH 14 D(565) | 22-17-3142   | A-4455-BH 14 D(208) |
| 15   | 22-16-2150   | A-4455-AZ 15 A(208) | 22-14-2154   | A-4455-BH 15 D(P909) | 22-17-2152   | A-4455-BH 15 D(565) | 22-17-3152   | A-4455-BH 15 D(208) |
| 16   | 22-16-2160   | A-4455-AZ 16 A(208) | 22-14-2164   | A-4455-BH 16 D(P909) | 22-17-2162   | A-4455-BH 16 D(565) | 22-17-3162   | A-4455-BH 16 D(208) |
| 17   | 22-16-2170   | A-4455-AZ 17 A(208) | 22-14-2174   | A-4455-BH 17 D(P909) | 22-17-2172   | A-4455-BH 17 D(565) | 22-17-3172   | A-4455-BH 17 D(208) |
| 18   | 22-16-2180   | A-4455-AZ 18 A(208) | 22-14-2184   | A-4455-BH 18 D(P909) | 22-17-2182   | A-4455-BH 18 D(565) | 22-17-3182   | A-4455-BH 18 D(208) |
| 19   | 22-16-2190   | A-4455-AZ 19 A(208) | 22-14-2194   | A-4455-BH 19 D(P909) | 22-17-2192   | A-4455-BH 19 D(565) | 22-17-3192   | A-4455-BH 19 D(208) |
| 20   | 22-16-2200   | A-4455-AZ 20 A(208) | 22-14-2204   | A-4455-BH 20 D(P909) | 22-17-2202   | A-4455-BH 20 D(565) | 22-17-3202   | A-4455-BH 20 D(208) |
| 21   | 22-16-2210   | A-4455-AZ 21 A(208) | 22-14-2214   | A-4455-BH 21 D(P909) | 22-17-2212   | A-4455-BH 21 D(565) | 22-17-3212   | A-4455-BH 21 D(208) |
| 22   | 22-16-2220   | A-4455-AZ 22 A(208) | 22-14-2224   | A-4455-BH 22 D(P909) | 22-17-2222   | A-4455-BH 22 D(565) | 22-17-3222   | A-4455-BH 22 D(208) |
| 23   | 22-16-2230   | A-4455-AZ 23 A(208) | 22-14-2234   | A-4455-BH 23 D(P909) | 22-17-2232   | A-4455-BH 23 D(565) | 22-17-3232   | A-4455-BH 23 D(208) |
| 24   | 22-16-2240   | A-4455-AZ 24 A(208) | 22-14-2244   | A-4455-BH 24 D(P909) | 22-17-2242   | A-4455-BH 24 D(565) | 22-17-3242   | A-4455-BH 24 D(208) |
| 25   | 22-16-2250   | A-4455-AZ 25 A(208) | 22-14-2254   | A-4455-BH 25 D(P909) | 22-17-2252   | A-4455-BH 25 D(565) | 22-17-3252   | A-4455-BH 25 D(208) |

|                         |                             |  |                  |
|-------------------------|-----------------------------|--|------------------|
| REV:                    | <b>ECR/ECN INFORMATION:</b> | <b>TITLE:</b>                              | <b>SHEET No.</b> |
| <b>D14</b>              | EC No.:                     | <b>KK 100 PCB ASSY<br/>4455 SERIES DWG</b> | <b>- 3 -</b>     |
|                         | DATE: <b>3/4/2020</b>       |  |                  |
| <b>DOCUMENT NUMBER:</b> | <b>SDA-4455</b>             | <b>CREATED / REVISED BY:</b>               | <b>SS06</b>      |
|                         |                             | <b>CHECKED BY:</b>                         | <b>SS06</b>      |
|                         |                             | <b>APPROVED BY:</b>                        | <b>ISHWARG</b>   |



## KK 100 PCB ASSY 2-25 CKT 4455 SERIES

| Ckts | Assy Proc: TOP ENTRY |                      | Assy Proc: TOP ENTRY |                     | Assy Proc: TOP ENTRY |                     | Assy Proc: RIGHT ANGLE |                     |
|------|----------------------|----------------------|----------------------|---------------------|----------------------|---------------------|------------------------|---------------------|
|      | Material No          | Engineer Number      | Material No          | Engineer Number     | Material No          | Engineer Number     | Material No            | Engineer Number     |
| 2    | 22-02-2025           | A-4455-CZ02A(P909)   | 22-18-2023           | A-4455-CZ02A(565)   | 22-18-2021           | A-4455-CZ02A(208)   | 22-15-4025             | A-4455-AZ02B(P909)  |
| 3    | 22-02-2035           | A-4455-CZ 03A(P909)  | 22-18-2033           | A-4455-CZ 03 A(565) | 22-18-2031           | A-4455-CZ 03 A(208) | 22-15-4035             | A-4455-AZ 03B(P909) |
| 4    | 22-02-2045           | A-4455-CZ 04A(P909)  | 22-18-2043           | A-4455-CZ 04 A(565) | 22-18-2041           | A-4455-CZ 04 A(208) | 22-15-4045             | A-4455-AZ 04B(P909) |
| 5    | 22-02-2055           | A-4455-CZ 05A(P909)  | 22-18-2053           | A-4455-CZ 05 A(565) | 22-18-2051           | A-4455-CZ 05 A(208) | 22-15-4055             | A-4455-AZ 05B(P909) |
| 6    | 22-02-2065           | A-4455-CZ 06A(P909)  | 22-18-2063           | A-4455-CZ 06 A(565) | 22-18-2061           | A-4455-CZ 06 A(208) | 22-15-4065             | A-4455-AZ 06B(P909) |
| 7    | 22-02-2075           | A-4455-CZ 07A(P909)  | 22-18-2073           | A-4455-CZ 07 A(565) | 22-18-2071           | A-4455-CZ 07 A(208) | 22-15-4075             | A-4455-AZ 07B(P909) |
| 8    | 22-02-2085           | A-4455-CZ 08 A(P909) | 22-18-2083           | A-4455-CZ 08 A(565) | 22-18-2081           | A-4455-CZ 08 A(208) | 22-15-4085             | A-4455-AZ 08B(P909) |
| 9    | 22-02-2095           | A-4455-CZ 09 A(P909) | 22-18-2093           | A-4455-CZ 09 A(565) | 22-18-2091           | A-4455-CZ 09 A(208) | 22-15-4095             | A-4455-AZ 09B(P909) |
| 10   | 22-02-2105           | A-4455-CZ 10 A(P909) | 22-18-2103           | A-4455-CZ 10 A(565) | 22-18-2101           | A-4455-CZ 10 A(208) | 22-15-4105             | A-4455-AZ 10B(P909) |
| 11   | 22-02-2115           | A-4455-CZ 11 A(P909) | 22-18-2113           | A-4455-CZ 11 A(565) | 22-18-2111           | A-4455-CZ 11 A(208) | 22-15-4115             | A-4455-AZ 11B(P909) |
| 12   | 22-02-2125           | A-4455-CZ 12 A(P909) | 22-18-2123           | A-4455-CZ 12 A(565) | 22-18-2121           | A-4455-CZ 12 A(208) | 22-15-4125             | A-4455-AZ 12B(P909) |
| 13   | 22-02-2135           | A-4455-CZ 13 A(P909) | 22-18-2133           | A-4455-CZ 13 A(565) | 22-18-2131           | A-4455-CZ 13 A(208) | 22-15-4135             | A-4455-AZ 13B(P909) |
| 14   | 22-02-2145           | A-4455-CZ 14 A(P909) | 22-18-2143           | A-4455-CZ 14 A(565) | 22-18-2141           | A-4455-CZ 14 A(208) | 22-15-4145             | A-4455-AZ 14B(P909) |
| 15   | 22-02-2155           | A-4455-CZ 15 A(P909) | 22-18-2153           | A-4455-CZ 15 A(565) | 22-18-2151           | A-4455-CZ 15 A(208) | 22-15-4155             | A-4455-AZ 15B(P909) |
| 16   | 22-02-2165           | A-4455-CZ 16 A(P909) | 22-18-2163           | A-4455-CZ 16 A(565) | 22-18-2161           | A-4455-CZ 16 A(208) | 22-15-4165             | A-4455-AZ 16B(P909) |
| 17   | 22-02-2175           | A-4455-CZ 17 A(P909) | 22-18-2173           | A-4455-CZ 17 A(565) | 22-18-2171           | A-4455-CZ 17 A(208) | 22-15-4175             | A-4455-AZ 17B(P909) |
| 18   | 22-02-2185           | A-4455-CZ 18 A(P909) | 22-18-2183           | A-4455-CZ 18 A(565) | 22-18-2181           | A-4455-CZ 18 A(208) | 22-15-4185             | A-4455-AZ 18B(P909) |
| 19   | 22-02-2195           | A-4455-CZ 19 A(P909) | 22-18-2193           | A-4455-CZ 19 A(565) | 22-18-2191           | A-4455-CZ 19 A(208) | 22-15-4195             | A-4455-AZ 19B(P909) |
| 20   | 22-02-2205           | A-4455-CZ 20 A(P909) | 22-18-2203           | A-4455-CZ 20 A(565) | 22-18-2201           | A-4455-CZ 20 A(208) | 22-15-4205             | A-4455-AZ 20B(P909) |
| 21   | 22-02-2215           | A-4455-CZ 21 A(P909) | 22-18-2213           | A-4455-CZ 21 A(565) | 22-18-2211           | A-4455-CZ 21 A(208) | 22-15-4215             | A-4455-AZ 21B(P909) |
| 22   | 22-02-2225           | A-4455-CZ 22 A(P909) | 22-18-2223           | A-4455-CZ 22 A(565) | 22-18-2221           | A-4455-CZ 22 A(208) | 22-15-4225             | A-4455-AZ 22B(P909) |
| 23   | 22-02-2235           | A-4455-CZ 23 A(P909) | 22-18-2233           | A-4455-CZ 23 A(565) | 22-18-2231           | A-4455-CZ 23 A(208) | 22-15-4235             | A-4455-AZ 23B(P909) |
| 24   | 22-02-2245           | A-4455-CZ 24 A(P909) | 22-18-2243           | A-4455-CZ 24 A(565) | 22-18-2241           | A-4455-CZ 24 A(208) | 22-15-4245             | A-4455-AZ 24B(P909) |
| 25   | 22-02-2255           | A-4455-CZ 25 A(P909) | 22-18-2253           | A-4455-CZ 25 A(565) | 22-18-2251           | A-4455-CZ 25 A(208) | 22-15-4255             | A-4455-AZ 25B(P909) |

|                  |                             |  |                |
|------------------|-----------------------------|--|----------------|
| REV:             | <b>ECR/ECN INFORMATION:</b> | TITLE:                                     | SHEET No.      |
| <b>D14</b>       | EC No.:                     | <b>KK 100 PCB ASSY<br/>4455 SERIES DWG</b> | <b>- 4 -</b>   |
|                  | DATE: <b>3/4/2020</b>       |  |                |
| DOCUMENT NUMBER: | CREATED / REVISED BY:       | CHECKED BY:                                | APPROVED BY:   |
| <b>SDA-4455</b>  | <b>SS06</b>                 | <b>SS06</b>                                | <b>ISHWARG</b> |



## KK 100 PCB ASSY 2-25 CKT 4455 SERIES

| Ckts | Assy Proc: RIGHT ANGLE |                     | Assy Proc: RIGHT ANGLE |                     | Assy Proc: BOTTOM ENTRY |                     | Assy Proc: BOTTOM ENTRY |                     |
|------|------------------------|---------------------|------------------------|---------------------|-------------------------|---------------------|-------------------------|---------------------|
|      | Material No            | Engineer Number     | Material No            | Engineer Number     | Material No             | Engineer Number     | Material No             | Engineer Number     |
| 2    | 22-16-2024             | A-4455-AZ02B(565)   |                        | A-4455-AZ02B(208)   | 22-17-2021              | A-4455-BH02J(565)   |                         | A-4455-BH02J(208)   |
| 3    | 22-16-2034             | A-4455-AZ 03 B(565) |                        | A-4455-AZ 03 B(208) | 22-17-2031              | A-4455-BH 03 J(565) |                         | A-4455-BH 03 J(208) |
| 4    | 22-16-2044             | A-4455-AZ 04 B(565) |                        | A-4455-AZ 04 B(208) | 22-17-2041              | A-4455-BH 04 J(565) |                         | A-4455-BH 04 J(208) |
| 5    | 22-16-2054             | A-4455-AZ 05 B(565) |                        | A-4455-AZ 05 B(208) | 22-17-2051              | A-4455-BH 05 J(565) |                         | A-4455-BH 05 J(208) |
| 6    | 22-16-2064             | A-4455-AZ 06 B(565) |                        | A-4455-AZ 06 B(208) | 22-17-2061              | A-4455-BH 06 J(565) |                         | A-4455-BH 06 J(208) |
| 7    | 22-16-2074             | A-4455-AZ 07 B(565) |                        | A-4455-AZ 07 B(208) | 22-17-2071              | A-4455-BH 07 J(565) |                         | A-4455-BH 07 J(208) |
| 8    | 22-16-2084             | A-4455-AZ 08 B(565) |                        | A-4455-AZ 08 B(208) | 22-17-2081              | A-4455-BH 08 J(565) |                         | A-4455-BH 08 J(208) |
| 9    | 22-16-2094             | A-4455-AZ 09 B(565) |                        | A-4455-AZ 09 B(208) | 22-17-2091              | A-4455-BH 09 J(565) |                         | A-4455-BH 09 J(208) |
| 10   | 22-16-2104             | A-4455-AZ 10 B(565) |                        | A-4455-AZ 10 B(208) | 22-17-2101              | A-4455-BH 10 J(565) |                         | A-4455-BH 10 J(208) |
| 11   | 22-16-2114             | A-4455-AZ 11 B(565) |                        | A-4455-AZ 11 B(208) | 22-17-2111              | A-4455-BH 11 J(565) |                         | A-4455-BH 11 J(208) |
| 12   | 22-16-2124             | A-4455-AZ 12 B(565) |                        | A-4455-AZ 12 B(208) | 22-17-2121              | A-4455-BH 12 J(565) |                         | A-4455-BH 12 J(208) |
| 13   | 22-16-2134             | A-4455-AZ 13 B(565) |                        | A-4455-AZ 13 B(208) | 22-17-2131              | A-4455-BH 13 J(565) |                         | A-4455-BH 13 J(208) |
| 14   | 22-16-2144             | A-4455-AZ 14 B(565) |                        | A-4455-AZ 14 B(208) | 22-17-2141              | A-4455-BH 14 J(565) |                         | A-4455-BH 14 J(208) |
| 15   | 22-16-2154             | A-4455-AZ 15 B(565) |                        | A-4455-AZ 15 B(208) | 22-17-2151              | A-4455-BH 15 J(565) |                         | A-4455-BH 15 J(208) |
| 16   | 22-16-2164             | A-4455-AZ 16 B(565) |                        | A-4455-AZ 16 B(208) | 22-17-2161              | A-4455-BH 16 J(565) |                         | A-4455-BH 16 J(208) |
| 17   | 22-16-2174             | A-4455-AZ 17 B(565) |                        | A-4455-AZ 17 B(208) | 22-17-2171              | A-4455-BH 17 J(565) |                         | A-4455-BH 17 J(208) |
| 18   | 22-16-2184             | A-4455-AZ 18 B(565) |                        | A-4455-AZ 18 B(208) | 22-17-2181              | A-4455-BH 18 J(565) |                         | A-4455-BH 18 J(208) |
| 19   | 22-16-2194             | A-4455-AZ 19 B(565) |                        | A-4455-AZ 19 B(208) | 22-17-2191              | A-4455-BH 19 J(565) |                         | A-4455-BH 19 J(208) |
| 20   | 22-16-2204             | A-4455-AZ 20 B(565) |                        | A-4455-AZ 20 B(208) | 22-17-2201              | A-4455-BH 20 J(565) |                         | A-4455-BH 20 J(208) |
| 21   | 22-16-2214             | A-4455-AZ 21 B(565) |                        | A-4455-AZ 21 B(208) | 22-17-2211              | A-4455-BH 21 J(565) |                         | A-4455-BH 21 J(208) |
| 22   | 22-16-2224             | A-4455-AZ 22 B(565) |                        | A-4455-AZ 22 B(208) | 22-17-2221              | A-4455-BH 22 J(565) |                         | A-4455-BH 22 J(208) |
| 23   | 22-16-2234             | A-4455-AZ 23 B(565) |                        | A-4455-AZ 23 B(208) | 22-17-2231              | A-4455-BH 23 J(565) |                         | A-4455-BH 23 J(208) |
| 24   | 22-16-2244             | A-4455-AZ 24 B(565) |                        | A-4455-AZ 24 B(208) | 22-17-2241              | A-4455-BH 24 J(565) |                         | A-4455-BH 24 J(208) |
| 25   | 22-16-2254             | A-4455-AZ 25 B(565) |                        | A-4455-AZ 25 B(208) | 22-17-2251              | A-4455-BH 25 J(565) |                         | A-4455-BH 25 J(208) |

|                         |                             |  |                  |
|-------------------------|-----------------------------|--|------------------|
| REV:                    | <b>ECR/ECN INFORMATION:</b> | <b>TITLE:</b>                              | <b>SHEET No.</b> |
| <b>D14</b>              | EC No.:                     | <b>KK 100 PCB ASSY<br/>4455 SERIES DWG</b> | <b>- 5 -</b>     |
|                         | DATE: <b>3/4/2020</b>       |  |                  |
| <b>DOCUMENT NUMBER:</b> | <b>SDA-4455</b>             | <b>CREATED / REVISED BY:</b>               | <b>SS06</b>      |
|                         |                             | <b>CHECKED BY:</b>                         | <b>SS06</b>      |
|                         |                             | <b>APPROVED BY:</b>                        | <b>ISHWARG</b>   |



## KK 100 PCB ASSY 2-25 CKT 4455 SERIES

| Ckts | Assy Proc: TOP ENTRY |                      | Assy Proc: TOP ENTRY |                     | Assy Proc: TOP ENTRY |                     | Assy Proc: RIGHT ANGLE |                     |
|------|----------------------|----------------------|----------------------|---------------------|----------------------|---------------------|------------------------|---------------------|
|      |                      | Hooks Cut:           | NO                   | Hooks Cut:          | NO                   | Hooks Cut:          | NO                     | Hooks Cut:          |
|      | Housing No:          | 4455-N               | Housing No:          | 4455-N              | Housing No:          | 4455-4              | Housing No:            | 4455-AN             |
|      | Terminal No:         | 6516-4(P909)         | Terminal No:         | 6516-4(565)         | Terminal No:         | 6516-4(208)         | Terminal No:           | 4316-4(P909)        |
|      | Dim C:               | 3.35 / .132          | Dim C:               | 3.35 / .132         | Dim C:               | 3.35 / .132         | Dim C:                 | 3.35 / .132         |
|      | Plating:             | P909                 | Plating:             | 565                 | Plating:             | 208                 | Plating:               | P909                |
|      | Packaging:           | PK-44646-001         | Packaging:           | PK-44646-001        | Packaging:           | PK-44646-001        | Packaging:             | PK-44646-001        |
|      | Voids:               | NONE                 | Voids:               | NONE                | Voids:               | NONE                | Voids:                 | NONE                |
|      |                      |                      |                      |                     |                      |                     |                        |                     |
|      | Material No          | Engineer Number      | Material No          | Engineer Number     | Material No          | Engineer Number     | Material No            | Engineer Number     |
| 2    |                      | A-4455-CZ02B(P909)   | 22-18-2022           | A-4455-CZ02B(565)   |                      | A-4455-CZ02B(208)   |                        |                     |
| 3    |                      | A-4455-CZ 03 B(P909) | 22-18-2032           | A-4455-CZ 03 B(565) |                      | A-4455-CZ 03B(208)  |                        |                     |
| 4    |                      | A-4455-CZ 04 B(P909) | 22-18-2042           | A-4455-CZ 04 B(565) |                      | A-4455-CZ 04 B(208) |                        |                     |
| 5    |                      | A-4455-CZ 05 B(P909) | 22-18-2052           | A-4455-CZ 05 B(565) |                      | A-4455-CZ 05 B(208) |                        |                     |
| 6    |                      | A-4455-CZ 06 B(P909) | 22-18-2062           | A-4455-CZ 06 B(565) |                      | A-4455-CZ 06 B(208) |                        |                     |
| 7    |                      | A-4455-CZ 07 B(P909) | 22-18-2072           | A-4455-CZ 07 B(565) |                      | A-4455-CZ 07 B(208) | 22-15-2075             | A-4455-AA07A(P909)  |
| 8    |                      | A-4455-CZ 08 B(P909) | 22-18-2082           | A-4455-CZ 08 B(565) |                      | A-4455-CZ 08 B(208) | 22-15-2085             | A-4455-AA 08A(P909) |
| 9    |                      | A-4455-CZ 09 B(P909) | 22-18-2092           | A-4455-CZ 09 B(565) |                      | A-4455-CZ 09 B(208) | 22-15-2095             | A-4455-AA 09A(P909) |
| 10   |                      | A-4455-CZ 10 B(P909) | 22-18-2102           | A-4455-CZ 10 B(565) |                      | A-4455-CZ 10 B(208) | 22-15-2105             | A-4455-AA 10A(P909) |
| 11   |                      | A-4455-CZ 11 B(P909) | 22-18-2112           | A-4455-CZ 11 B(565) |                      | A-4455-CZ 11 B(208) | 22-15-2115             | A-4455-AA 11A(P909) |
| 12   |                      | A-4455-CZ 12 B(P909) | 22-18-2122           | A-4455-CZ 12 B(565) |                      | A-4455-CZ 12 B(208) | 22-15-2125             | A-4455-AA 12A(P909) |
| 13   |                      | A-4455-CZ 13 B(P909) | 22-18-2132           | A-4455-CZ 13 B(565) |                      | A-4455-CZ 13 B(208) | 22-15-2135             | A-4455-AA 13A(P909) |
| 14   |                      | A-4455-CZ 14 B(P909) | 22-18-2142           | A-4455-CZ 14 B(565) |                      | A-4455-CZ 14 B(208) | 22-15-2145             | A-4455-AA 14A(P909) |
| 15   |                      | A-4455-CZ 15 B(P909) | 22-18-2152           | A-4455-CZ 15 B(565) |                      | A-4455-CZ 15 B(208) | 22-15-2155             | A-4455-AA 15A(P909) |
| 16   |                      | A-4455-CZ 16 B(P909) | 22-18-2162           | A-4455-CZ 16 B(565) |                      | A-4455-CZ 16 B(208) | 22-15-2165             | A-4455-AA 16A(P909) |
| 17   |                      | A-4455-CZ 17 B(P909) | 22-18-2172           | A-4455-CZ 17 B(565) |                      | A-4455-CZ 17 B(208) | 22-15-2175             | A-4455-AA 17A(P909) |
| 18   |                      | A-4455-CZ 18 B(P909) | 22-18-2182           | A-4455-CZ 18 B(565) |                      | A-4455-CZ 18 B(208) | 22-15-2185             | A-4455-AA 18A(P909) |
| 19   |                      | A-4455-CZ 19 B(P909) | 22-18-2192           | A-4455-CZ 19 B(565) |                      | A-4455-CZ 19 B(208) | 22-15-2195             | A-4455-AA 19A(P909) |
| 20   |                      | A-4455-CZ 20 B(P909) | 22-18-2202           | A-4455-CZ 20 B(565) |                      | A-4455-CZ 20 B(208) | 22-15-2205             | A-4455-AA 20A(P909) |
| 21   |                      | A-4455-CZ 21 B(P909) | 22-18-2212           | A-4455-CZ 21 B(565) |                      | A-4455-CZ 21 B(208) | 22-15-2215             | A-4455-AA 21A(P909) |
| 22   |                      | A-4455-CZ 22 B(P909) | 22-18-2222           | A-4455-CZ 22 B(565) |                      | A-4455-CZ 22 B(208) | 22-15-2225             | A-4455-AA 22A(P909) |
| 23   |                      | A-4455-CZ 23 B(P909) | 22-18-2232           | A-4455-CZ 23 B(565) |                      | A-4455-CZ 23 B(208) | 22-15-2235             | A-4455-AA 23A(P909) |
| 24   |                      | A-4455-CZ 24 B(P909) | 22-18-2242           | A-4455-CZ 24 B(565) |                      | A-4455-CZ 24 B(208) | 22-15-2245             | A-4455-AA 24A(P909) |
| 25   |                      | A-4455-CZ 25 B(P909) | 22-18-2252           | A-4455-CZ 25 B(565) |                      | A-4455-CZ 25 B(208) | 22-15-2255             | A-4455-AA 25A(P909) |

|                  |                             |  |                |
|------------------|-----------------------------|--|----------------|
| REV:             | <b>ECR/ECN INFORMATION:</b> | TITLE:                                     | SHEET No.      |
| <b>D14</b>       | EC No.:                     | <b>KK 100 PCB ASSY<br/>4455 SERIES DWG</b> | <b>- 6 -</b>   |
|                  | DATE: <b>3/4/2020</b>       |  |                |
| DOCUMENT NUMBER: | CREATED / REVISED BY:       | CHECKED BY:                                | APPROVED BY:   |
| <b>SDA-4455</b>  | <b>SS06</b>                 | <b>SS06</b>                                | <b>ISHWARG</b> |



## KK 100 PCB ASSY 2-25 CKT 4455 SERIES

|      | Assy Proc:   | RIGHT ANGLE         | Assy Proc:   | RIGHT ANGLE         | Assy Proc:   | RIGHT ANGLE         | Assy Proc:   | RIGHT ANGLE         |
|------|--------------|---------------------|--------------|---------------------|--------------|---------------------|--------------|---------------------|
|      | Hooks Cut:   | NO                  | Hooks Cut:   | NO                  | Hooks Cut:   | NO                  | Hooks Cut:   | NO                  |
|      | Housing No:  | 4455-AN             | Housing No:  | 4455-BN             | Housing No:  | 4455-BN             | Housing No:  | 4455-NHH            |
|      | Terminal No: | 4316-4(208)         | Terminal No: | 4316-4(228)         | Terminal No: | 4316-4(P909)        | Terminal No: | 4316-4(P909)        |
|      | Dim C:       | 3.35 / .132         | Dim C:       | 3.35 / .132         | Dim C:       | 3.35 / .132         | Dim C:       | 3.35 / .132         |
|      | Plating:     | 208                 | Plating:     | 228                 | Plating:     | P909                | Plating:     | P909                |
|      | Packaging:   | PK-44646-001        | Packaging:   | PK-44646-002        | Packaging:   | PK-44646-002        | Packaging:   | PK-44646-001        |
|      | Voids:       | NONE                | Voids:       | NONE                | Voids:       | NONE                | Voids:       | NONE                |
|      |              |                     |              |                     |              |                     |              |                     |
| Ckts | Material No  | Engineer Number     | Material No  | Engineer Number     | Material No  | Engineer Number     | Material No  | Engineer Number     |
| 2    |              |                     |              | A-4455-AB02A(228)   | 22-15-4024   | A-4455-AB02A(P909)  | 22-15-2022   | A-4455-AE02A(P909)  |
| 3    |              |                     |              | A-4455-AB 03 A(228) | 22-15-4034   | A-4455-AB 03A(P909) | 22-15-2032   | A-4455-AE 03A(P909) |
| 4    |              |                     |              | A-4455-AB 04 A(228) | 22-15-4044   | A-4455-AB 04A(P909) | 22-15-2042   | A-4455-AE 04A(P909) |
| 5    |              |                     |              | A-4455-AB 05 A(228) | 22-15-4054   | A-4455-AB 05A(P909) | 22-15-2052   | A-4455-AE 05A(P909) |
| 6    |              |                     | 50-34-8518   | A-4455-AB 06 A(228) | 22-15-4064   | A-4455-AB 06A(P909) | 22-15-2062   | A-4455-AE 06A(P909) |
| 7    | 22-16-2076   | A-4455-AA07A(208)   |              | A-4455-AB 07 A(228) | 22-15-4074   | A-4455-AB 07A(P909) | 22-15-2072   | A-4455-AE 07A(P909) |
| 8    | 22-16-2086   | A-4455-AA 08 A(208) |              | A-4455-AB 08 A(228) | 22-15-4084   | A-4455-AB 08A(P909) | 22-15-2082   | A-4455-AE 08A(P909) |
| 9    | 22-16-2096   | A-4455-AA 09 A(208) |              | A-4455-AB 09 A(228) | 22-15-4094   | A-4455-AB 09A(P909) | 22-15-2092   | A-4455-AE 09A(P909) |
| 10   | 22-16-2106   | A-4455-AA 10 A(208) |              | A-4455-AB 10 A(228) | 22-15-4104   | A-4455-AB 10A(P909) | 22-15-2102   | A-4455-AE 10A(P909) |
| 11   | 22-16-2116   | A-4455-AA 11 A(208) |              | A-4455-AB 11 A(228) | 22-15-4114   | A-4455-AB 11A(P909) | 22-15-2112   | A-4455-AE 11A(P909) |
| 12   | 22-16-2126   | A-4455-AA 12 A(208) |              | A-4455-AB 12 A(228) | 22-15-4124   | A-4455-AB 12A(P909) | 22-15-2122   | A-4455-AE 12A(P909) |
| 13   | 22-16-2136   | A-4455-AA 13 A(208) |              | A-4455-AB 13 A(228) | 22-15-4134   | A-4455-AB 13A(P909) | 22-15-2132   | A-4455-AE 13A(P909) |
| 14   | 22-16-2146   | A-4455-AA 14 A(208) |              | A-4455-AB 14 A(228) | 22-15-4144   | A-4455-AB 14A(P909) | 22-15-2142   | A-4455-AE 14A(P909) |
| 15   | 22-16-2156   | A-4455-AA 15 A(208) |              | A-4455-AB 15 A(228) | 22-15-4154   | A-4455-AB 15A(P909) | 22-15-2152   | A-4455-AE 15A(P909) |
| 16   | 22-16-2166   | A-4455-AA 16 A(208) |              | A-4455-AB 16 A(228) | 22-15-4164   | A-4455-AB 16A(P909) | 22-15-2162   | A-4455-AE 16A(P909) |
| 17   | 22-16-2176   | A-4455-AA 17 A(208) |              | A-4455-AB 17 A(228) | 22-15-4174   | A-4455-AB 17A(P909) | 22-15-2172   | A-4455-AE 17A(P909) |
| 18   | 22-16-2186   | A-4455-AA 18 A(208) |              | A-4455-AB 18 A(228) | 22-15-4184   | A-4455-AB 18A(P909) | 22-15-2182   | A-4455-AE 18A(P909) |
| 19   | 22-16-2196   | A-4455-AA 19 A(208) |              | A-4455-AB 19 A(228) | 22-15-4194   | A-4455-AB 19A(P909) | 22-15-2192   | A-4455-AE 19A(P909) |
| 20   | 22-16-2206   | A-4455-AA 20 A(208) |              | A-4455-AB 20 A(228) | 22-15-4204   | A-4455-AB 20A(P909) | 22-15-2202   | A-4455-AE 20A(P909) |
| 21   | 22-16-2216   | A-4455-AA 21 A(208) |              | A-4455-AB 21 A(228) | 22-15-4214   | A-4455-AB 21A(P909) | 22-15-2212   | A-4455-AE 21A(P909) |
| 22   | 22-16-2226   | A-4455-AA 22 A(208) |              | A-4455-AB 22 A(228) | 22-15-4224   | A-4455-AB 22A(P909) | 22-15-2222   | A-4455-AE 22A(P909) |
| 23   | 22-16-2236   | A-4455-AA 23 A(208) |              | A-4455-AB 23 A(228) | 22-15-4234   | A-4455-AB 23A(P909) | 22-15-2232   | A-4455-AE 23A(P909) |
| 24   | 22-16-2246   | A-4455-AA 24 A(208) | 22-17-3240   | A-4455-AB 24 A(228) | 22-15-4244   | A-4455-AB 24A(P909) | 22-15-2242   | A-4455-AE 24A(P909) |
| 25   | 22-16-2256   | A-4455-AA 25 A(208) |              | A-4455-AB 25 A(228) | 22-15-4254   | A-4455-AB 25A(P909) | 22-15-2252   | A-4455-AE 25A(P909) |

|                         |                             |  |                    |
|-------------------------|-----------------------------|--|--------------------|
| REV:                    | <b>ECR/ECN INFORMATION:</b> | <b>TITLE:</b>                              | <b>SHEET No.</b>   |
| <b>D14</b>              | EC No.:                     | <b>KK 100 PCB ASSY<br/>4455 SERIES DWG</b> | <b>- 7 -</b>       |
|                         | DATE: <b>3/4/2020</b>       |  |                    |
| <b>DOCUMENT NUMBER:</b> |                             | <b>CREATED / REVISED BY:</b>               | <b>CHECKED BY:</b> |
| <b>SDA-4455</b>         |                             | <b>SS06</b>                                | <b>SS06</b>        |
|                         |                             | <b>APPROVED BY:</b>                        |                    |
|                         |                             | <b>ISHWARG</b>                             |                    |



## KK 100 PCB ASSY 2-25 CKT 4455 SERIES

|      | Assy Proc:   | RIGHT ANGLE          | Assy Proc:   | RIGHT ANGLE         | Assy Proc:   | RIGHT ANGLE         | Assy Proc:   | RIGHT ANGLE         |
|------|--------------|----------------------|--------------|---------------------|--------------|---------------------|--------------|---------------------|
|      | Hooks Cut:   | NO                   | Hooks Cut:   | NO                  | Hooks Cut:   | NO                  | Hooks Cut:   | NO                  |
|      | Housing No:  | 4455-NR              | Housing No:  | 4455-N              | Housing No:  | 4455-N              | Housing No:  | 4455-N              |
|      | Terminal No: | 4316-4(P909)         | Terminal No: | 4316-4(228)         | Terminal No: | 6516-4(228)         | Terminal No: | 6516-4(228)         |
|      | Dim C:       | 3.35 / .132          | Dim C:       | 3.35 / .132         | Dim C:       | 3.35 / .132         | Dim C:       | 3.35 / .132         |
|      | Plating:     | P909                 | Plating:     | 228                 | Plating:     | 228                 | Plating:     | 228                 |
|      | Packaging:   | PK-44646-001         | Packaging:   | PK-44646-001        | Packaging:   | PK-44646-001        | Packaging:   | PK-44646-001        |
|      | Voids:       | NONE                 | Voids:       | NONE                | Voids:       | NONE                | Voids:       | NONE                |
|      |              |                      |              |                     |              |                     |              |                     |
| Ckts | Material No  | Engineer Number      | Material No  | Engineer Number     | Material No  | Engineer Number     | Material No  | Engineer Number     |
| 2    | 22-15-4022   | A-4455-AR02A(P909)   |              | A-4455-AZ02A(228)   | 22-17-5023   | A-4455-AZ02B(228)   | 22-16-2022   | A-4455-AZ02B(228)   |
| 3    | 22-15-4032   | A-4455-AR 03 A(P909) |              | A-4455-AZ 03 A(228) | 22-17-5033   | A-4455-AZ 03 B(228) | 22-16-2032   | A-4455-AZ 03 B(228) |
| 4    | 22-15-4042   | A-4455-AR 04 A(P909) |              | A-4455-AZ 04 A(228) | 22-17-5043   | A-4455-AZ 04 B(228) | 22-16-2042   | A-4455-AZ 04 B(228) |
| 5    | 22-15-4052   | A-4455-AR 05 A(P909) |              | A-4455-AZ 05 A(228) | 22-17-5053   | A-4455-AZ 05 B(228) | 22-16-2052   | A-4455-AZ 05 B(228) |
| 6    | 22-15-4062   | A-4455-AR 06 A(P909) |              | A-4455-AZ 06 A(228) | 22-17-5063   | A-4455-AZ 06 B(228) | 22-16-2062   | A-4455-AZ 06 B(228) |
| 7    | 22-15-4072   | A-4455-AR 07 A(P909) |              | A-4455-AZ 07 A(228) | 22-17-5073   | A-4455-AZ 07 B(228) | 22-16-2072   | A-4455-AZ 07 B(228) |
| 8    | 22-15-4082   | A-4455-AR 08 A(P909) |              | A-4455-AZ 08 A(228) | 22-17-5083   | A-4455-AZ 08 B(228) | 22-16-2082   | A-4455-AZ 08 B(228) |
| 9    | 22-15-4092   | A-4455-AR 09 A(P909) |              | A-4455-AZ 09 A(228) | 22-17-5093   | A-4455-AZ 09 B(228) | 22-16-2092   | A-4455-AZ 09 B(228) |
| 10   | 22-15-4102   | A-4455-AR 10 A(P909) |              | A-4455-AZ 10 A(228) | 22-17-5103   | A-4455-AZ 10 B(228) | 22-16-2102   | A-4455-AZ 10 B(228) |
| 11   | 22-15-4112   | A-4455-AR 11 A(P909) |              | A-4455-AZ 11 A(228) | 22-17-5113   | A-4455-AZ 11 B(228) | 22-16-2112   | A-4455-AZ 11 B(228) |
| 12   | 22-15-4122   | A-4455-AR 12 A(P909) |              | A-4455-AZ 12 A(228) | 22-17-5123   | A-4455-AZ 12 B(228) | 22-16-2122   | A-4455-AZ 12 B(228) |
| 13   | 22-15-4132   | A-4455-AR 13 A(P909) |              | A-4455-AZ 13 A(228) | 22-17-5133   | A-4455-AZ 13 B(228) | 22-16-2132   | A-4455-AZ 13 B(228) |
| 14   | 22-15-4142   | A-4455-AR 14 A(P909) |              | A-4455-AZ 14 A(228) | 22-17-5143   | A-4455-AZ 14 B(228) | 22-16-2142   | A-4455-AZ 14 B(228) |
| 15   | 22-15-4152   | A-4455-AR 15 A(P909) |              | A-4455-AZ 15 A(228) | 22-17-5153   | A-4455-AZ 15 B(228) | 22-16-2152   | A-4455-AZ 15 B(228) |
| 16   | 22-15-4162   | A-4455-AR 16 A(P909) |              | A-4455-AZ 16 A(228) | 22-17-5163   | A-4455-AZ 16 B(228) | 22-16-2162   | A-4455-AZ 16 B(228) |
| 17   | 22-15-4172   | A-4455-AR 17 A(P909) |              | A-4455-AZ 17 A(228) | 22-17-5173   | A-4455-AZ 17 B(228) | 22-16-2172   | A-4455-AZ 17 B(228) |
| 18   | 22-15-4182   | A-4455-AR 18 A(P909) |              | A-4455-AZ 18 A(228) | 22-17-5183   | A-4455-AZ 18 B(228) | 22-16-2182   | A-4455-AZ 18 B(228) |
| 19   | 22-15-4192   | A-4455-AR 19 A(P909) |              | A-4455-AZ 19 A(228) | 22-17-5193   | A-4455-AZ 19 B(228) | 22-16-2192   | A-4455-AZ 19 B(228) |
| 20   | 22-15-4202   | A-4455-AR 20 A(P909) | 22-17-5201   | A-4455-AZ 20 A(228) | 22-17-5203   | A-4455-AZ 20 B(228) | 22-16-2202   | A-4455-AZ 20 B(228) |
| 21   | 22-15-4212   | A-4455-AR 21 A(P909) |              | A-4455-AZ 21 A(228) | 22-17-5213   | A-4455-AZ 21 B(228) | 22-16-2212   | A-4455-AZ 21 B(228) |
| 22   | 22-15-4222   | A-4455-AR 22 A(P909) |              | A-4455-AZ 22 A(228) | 22-17-5223   | A-4455-AZ 22 B(228) | 22-16-2222   | A-4455-AZ 22 B(228) |
| 23   | 22-15-4232   | A-4455-AR 23 A(P909) |              | A-4455-AZ 23 A(228) | 22-17-5233   | A-4455-AZ 23 B(228) | 22-16-2232   | A-4455-AZ 23 B(228) |
| 24   | 22-15-4242   | A-4455-AR 24 A(P909) | 22-17-3247   | A-4455-AZ 24 A(228) | 22-17-5243   | A-4455-AZ 24 B(228) | 22-16-2242   | A-4455-AZ 24 B(228) |
| 25   | 22-15-4252   | A-4455-AR 25 A(P909) |              | A-4455-AZ 25 A(228) | 22-17-5253   | A-4455-AZ 25 B(228) | 22-16-2252   | A-4455-AZ 25 B(228) |

|                  |                             |  |                |
|------------------|-----------------------------|--|----------------|
| REV:             | <b>ECR/ECN INFORMATION:</b> | TITLE:                                     | SHEET No.      |
| <b>D14</b>       | EC No.:                     | <b>KK 100 PCB ASSY<br/>4455 SERIES DWG</b> | <b>- 8 -</b>   |
|                  | DATE: <b>3/4/2020</b>       |  |                |
| DOCUMENT NUMBER: | CREATED / REVISED BY:       | CHECKED BY:                                | APPROVED BY:   |
| <b>SDA-4455</b>  | <b>SS06</b>                 | <b>SS06</b>                                | <b>ISHWARG</b> |





## KK 100 PCB ASSY 2-25 CKT 4455 SERIES

|              |              |
|--------------|--------------|
| Assy Proc:   | BOTTOM ENTRY |
| Hooks Cut:   | NO           |
| Housing No:  | 4455-N2      |
| Terminal No: | 4316-3B(228) |
| Dim C:       | 3.35 / .132  |
| Plating:     | 228          |
| Packaging:   | PK-44646-001 |
| Voids:       | NO           |

|              |              |
|--------------|--------------|
| Assy Proc:   | BOTTOM ENTRY |
| Hooks Cut:   | NO           |
| Housing No:  | 4455-N2      |
| Terminal No: | 4316-3B(231) |
| Dim C:       | 3.35 / .132  |
| Plating:     | 231          |
| Packaging:   | PK-44646-001 |
| Voids:       | NO           |

|              |              |
|--------------|--------------|
| Assy Proc:   | BOTTOM ENTRY |
| Hooks Cut:   | NO           |
| Housing No:  | 4455-N2      |
| Terminal No: | 4316-3B(228) |
| Dim C:       | 3.35 / .132  |
| Plating:     | 228          |
| Packaging:   | PK-44646-001 |
| Voids:       | NO           |

|              |              |
|--------------|--------------|
| Assy Proc:   | BOTTOM ENTRY |
| Hooks Cut:   | NO           |
| Housing No:  | 4455-N2      |
| Terminal No: | 6516-3B(228) |
| Dim C:       | 3.35 / .132  |
| Plating:     | 228          |
| Packaging:   | PK-44646-001 |
| Voids:       | NO           |

| Ckts | Material No | Engineer Number   |
|------|-------------|-------------------|
| 2    | 22-17-2024  | A-4455-BH02D(228) |
| 3    | 22-17-2034  | A-4455-BH03D(228) |
| 4    | 22-17-2044  | A-4455-BH04D(228) |
| 5    | 22-17-2054  | A-4455-BH05D(228) |
| 6    | 22-17-2064  | A-4455-BH06D(228) |
| 7    | 22-17-2074  | A-4455-BH07D(228) |
| 8    | 22-17-2084  | A-4455-BH08D(228) |
| 9    | 22-17-2094  | A-4455-BH09D(228) |
| 10   | 22-17-2104  | A-4455-BH10D(228) |
| 11   | 22-17-2114  | A-4455-BH11D(228) |
| 12   | 22-17-2124  | A-4455-BH12D(228) |
| 13   | 22-17-2134  | A-4455-BH13D(228) |
| 14   | 22-17-2144  | A-4455-BH14D(228) |
| 15   | 22-17-2154  | A-4455-BH15D(228) |
| 16   | 22-17-2164  | A-4455-BH16D(228) |
| 17   | 22-17-2174  | A-4455-BH17D(228) |
| 18   | 22-17-2184  | A-4455-BH18D(228) |
| 19   | 22-17-2194  | A-4455-BH19D(228) |
| 20   | 22-17-2204  | A-4455-BH20D(228) |
| 21   | 22-17-2214  | A-4455-BH21D(228) |
| 22   | 22-17-2224  | A-4455-BH22D(228) |
| 23   | 22-17-2234  | A-4455-BH23D(228) |
| 24   | 22-17-2244  | A-4455-BH24D(228) |
| 25   | 22-17-2254  | A-4455-BH25D(228) |

| Material No | Engineer Number     |
|-------------|---------------------|
|             | A-4455-BH02D(231)   |
|             | A-4455-BH 03 D(231) |
|             | A-4455-BH 04 D(231) |
|             | A-4455-BH 05 D(231) |
|             | A-4455-BH 06 D(231) |
|             | A-4455-BH 07 D(231) |
|             | A-4455-BH 08 D(231) |
|             | A-4455-BH 09 D(231) |
|             | A-4455-BH 10 D(231) |
|             | A-4455-BH 11 D(231) |
|             | A-4455-BH 12 D(231) |
|             | A-4455-BH 13 D(231) |
| 22-17-2140  | A-4455-BH 14 D(231) |
|             | A-4455-BH 15 D(231) |
|             | A-4455-BH 16 D(231) |
|             | A-4455-BH 17 D(231) |
|             | A-4455-BH 18 D(231) |
|             | A-4455-BH 19 D(231) |
| 22-17-2200  | A-4455-BH 20 D(231) |
|             | A-4455-BH 21 D(231) |
|             | A-4455-BH 22 D(231) |
|             | A-4455-BH 23 D(231) |
|             | A-4455-BH 24 D(231) |
| 22-17-2250  | A-4455-BH 25 D(231) |

| Material No | Engineer Number   |
|-------------|-------------------|
|             | A-4455-BH02D(228) |
|             | A-4455-BH03D(228) |
|             | A-4455-BH04D(228) |
| 22-17-3056  | A-4455-BH05D(228) |
| 22-17-3066  | A-4455-BH06D(228) |
|             | A-4455-BH07D(228) |
| 22-17-3086  | A-4455-BH08D(228) |
|             | A-4455-BH09D(228) |
|             | A-4455-BH10D(228) |
|             | A-4455-BH11D(228) |
|             | A-4455-BH12D(228) |
|             | A-4455-BH13D(228) |
| 22-17-3146  | A-4455-BH14D(228) |
|             | A-4455-BH15D(228) |
|             | A-4455-BH16D(228) |
|             | A-4455-BH17D(228) |
|             | A-4455-BH18D(228) |
| 22-17-3196  | A-4455-BH19D(228) |
| 22-17-3206  | A-4455-BH20D(228) |
|             | A-4455-BH21D(228) |
|             | A-4455-BH22D(228) |
|             | A-4455-BH23D(228) |
|             | A-4455-BH24D(228) |
| 22-17-3256  | A-4455-BH25D(228) |

| Material No | Engineer Number   |
|-------------|-------------------|
| 22-17-2027  | A-4455-BH02J(228) |
| 22-17-2037  | A-4455-BH03J(228) |
| 22-17-2047  | A-4455-BH04J(228) |
| 22-17-2057  | A-4455-BH05J(228) |
| 22-17-2067  | A-4455-BH06J(228) |
| 22-17-2077  | A-4455-BH07J(228) |
| 22-17-2087  | A-4455-BH08J(228) |
| 22-17-2097  | A-4455-BH09J(228) |
| 22-17-2107  | A-4455-BH10J(228) |
| 22-17-2117  | A-4455-BH11J(228) |
| 22-17-2127  | A-4455-BH12J(228) |
| 22-17-2137  | A-4455-BH13J(228) |
| 22-17-2147  | A-4455-BH14J(228) |
| 22-17-2157  | A-4455-BH15J(228) |
| 22-17-2167  | A-4455-BH16J(228) |
| 22-17-2177  | A-4455-BH17J(228) |
| 22-17-2187  | A-4455-BH18J(228) |
| 22-17-2197  | A-4455-BH19J(228) |
| 22-17-2207  | A-4455-BH20J(228) |
| 22-17-2217  | A-4455-BH21J(228) |
| 22-17-2227  | A-4455-BH22J(228) |
| 22-17-2237  | A-4455-BH23J(228) |
| 22-17-2247  | A-4455-BH24J(228) |
| 22-17-2257  | A-4455-BH25J(228) |

|                         |                              |  |                     |
|-------------------------|------------------------------|--|---------------------|
| <b>REV:</b>             | <b>ECR/ECN INFORMATION:</b>  | <b>TITLE:</b>                              | <b>SHEET No.</b>    |
| <b>D14</b>              | EC No.:                      | <b>KK 100 PCB ASSY<br/>4455 SERIES DWG</b> | <b>- 9 -</b>        |
|                         | DATE: <b>3/4/2020</b>        |  |                     |
| <b>DOCUMENT NUMBER:</b> | <b>CREATED / REVISED BY:</b> | <b>CHECKED BY:</b>                         | <b>APPROVED BY:</b> |
| <b>SDA-4455</b>         | <b>SS06</b>                  | <b>SS06</b>                                | <b>ISHWARG</b>      |



## KK 100 PCB ASSY 2-25 CKT 4455 SERIES

|      | Assy Proc:   | TOP ENTRY           | Assy Proc:   | TOP ENTRY           | Assy Proc:   | TOP ENTRY           | Assy Proc:   | TOP ENTRY           |
|------|--------------|---------------------|--------------|---------------------|--------------|---------------------|--------------|---------------------|
|      | Hooks Cut:   | YES                 | Hooks Cut:   | YES                 | Hooks Cut:   | YES                 | Hooks Cut:   | NO                  |
|      | Housing No:  | 4455-NR             | Housing No:  | 4455-N              | Housing No:  | 4455-N              | Housing No:  | 4455-BN             |
|      | Terminal No: | 4316-4(208)         | Terminal No: | 4316-4(565)         | Terminal No: | 4316-4(P909)        | Terminal No: | 4316-4(P909)        |
|      | Dim C:       | 3.35 / .132         | Dim C:       | 3.35 / .132         | Dim C:       | 3.35 / .132         | Dim C:       | 3.35 / .132         |
|      | Plating:     | 208                 | Plating:     | 565                 | Plating:     | P909                | Plating:     | P909                |
|      | Packaging:   | PK-44646-003        | Packaging:   | PK-44646-003        | Packaging:   | PK-44646-003        | Packaging:   | PK-44646-002        |
|      | Voids:       | NO                  | Voids:       | NO                  | Voids:       | NO                  | Voids:       | NO                  |
|      |              |                     |              |                     |              |                     |              |                     |
| Ckts | Material No  | Engineer Number     | Material No  | Engineer Number     | Material No  | Engineer Number     | Material No  | Engineer Number     |
| 2    |              | A-4455-CP02A(208)   | 22-18-2026   | A-4455-CY02A(565)   | 22-02-7023   | A-4455-CY02A(P909)  | 22-15-4028   | A-4455-CB02A(P909)  |
| 3    |              | A-4455-CP 03 A(208) | 22-18-2036   | A-4455-CY 03 A(565) | 22-02-7033   | A-4455-CY 03A(P909) | 22-15-4038   | A-4455-CB 03A(P909) |
| 4    |              | A-4455-CP 04 A(208) | 22-18-2046   | A-4455-CY 04 A(565) | 22-02-7043   | A-4455-CY 04A(P909) | 22-15-4048   | A-4455-CB 04A(P909) |
| 5    | 22-18-2057   | A-4455-CP 05 A(208) | 22-18-2056   | A-4455-CY 05 A(565) | 22-02-7053   | A-4455-CY 05A(P909) | 22-15-4058   | A-4455-CB 05A(P909) |
| 6    |              | A-4455-CP 06 A(208) | 22-18-2066   | A-4455-CY 06 A(565) | 22-02-7063   | A-4455-CY 06A(P909) | 22-15-4068   | A-4455-CB 06A(P909) |
| 7    |              | A-4455-CP 07 A(208) | 22-18-2076   | A-4455-CY 07 A(565) | 22-02-7073   | A-4455-CY 07A(P909) | 22-15-4078   | A-4455-CB 07A(P909) |
| 8    |              | A-4455-CP 08 A(208) | 22-18-2086   | A-4455-CY 08 A(565) | 22-02-7083   | A-4455-CY 08A(P909) | 22-15-4088   | A-4455-CB 08A(P909) |
| 9    |              | A-4455-CP 09 A(208) | 22-18-2096   | A-4455-CY 09 A(565) | 22-02-7093   | A-4455-CY 09A(P909) | 22-15-4098   | A-4455-CB 09A(P909) |
| 10   |              | A-4455-CP 10 A(208) | 22-18-2106   | A-4455-CY 10 A(565) | 22-02-7103   | A-4455-CY 10A(P909) | 22-15-4108   | A-4455-CB 10A(P909) |
| 11   |              | A-4455-CP 11 A(208) | 22-18-2116   | A-4455-CY 11 A(565) | 22-02-7113   | A-4455-CY 11A(P909) | 22-15-4118   | A-4455-CB 11A(P909) |
| 12   |              | A-4455-CP 12 A(208) | 22-18-2126   | A-4455-CY 12 A(565) | 22-02-7123   | A-4455-CY 12A(P909) | 22-15-4128   | A-4455-CB 12A(P909) |
| 13   |              | A-4455-CP 13 A(208) | 22-18-2136   | A-4455-CY 13 A(565) | 22-02-7133   | A-4455-CY 13A(P909) | 22-15-4138   | A-4455-CB 13A(P909) |
| 14   |              | A-4455-CP 14 A(208) | 22-18-2146   | A-4455-CY 14 A(565) | 22-02-7143   | A-4455-CY 14A(P909) | 22-15-4148   | A-4455-CB 14A(P909) |
| 15   |              | A-4455-CP 15 A(208) | 22-18-2156   | A-4455-CY 15 A(565) | 22-02-7153   | A-4455-CY 15A(P909) | 22-15-4158   | A-4455-CB 15A(P909) |
| 16   |              | A-4455-CP 16 A(208) | 22-18-2166   | A-4455-CY 16 A(565) | 22-02-7163   | A-4455-CY 16A(P909) | 22-15-4168   | A-4455-CB 16A(P909) |
| 17   |              | A-4455-CP 17 A(208) | 22-18-2176   | A-4455-CY 17 A(565) | 22-02-7173   | A-4455-CY 17A(P909) | 22-15-4178   | A-4455-CB 17A(P909) |
| 18   |              | A-4455-CP 18 A(208) | 22-18-2186   | A-4455-CY 18 A(565) | 22-02-7183   | A-4455-CY 18A(P909) | 22-15-4188   | A-4455-CB 18A(P909) |
| 19   |              | A-4455-CP 19 A(208) | 22-18-2196   | A-4455-CY 19 A(565) | 22-02-7193   | A-4455-CY 19A(P909) | 22-15-4198   | A-4455-CB 19A(P909) |
| 20   |              | A-4455-CP 20 A(208) | 22-18-2206   | A-4455-CY 20 A(565) | 22-02-7203   | A-4455-CY 20A(P909) | 22-15-4208   | A-4455-CB 20A(P909) |
| 21   |              | A-4455-CP 21 A(208) | 22-18-2216   | A-4455-CY 21 A(565) | 22-02-7213   | A-4455-CY 21A(P909) | 22-15-4218   | A-4455-CB 21A(P909) |
| 22   |              | A-4455-CP 22 A(208) | 22-18-2226   | A-4455-CY 22 A(565) | 22-02-7223   | A-4455-CY 22A(P909) | 22-15-4228   | A-4455-CB 22A(P909) |
| 23   |              | A-4455-CP 23 A(208) | 22-18-2236   | A-4455-CY 23 A(565) | 22-02-7233   | A-4455-CY 23A(P909) | 22-15-4238   | A-4455-CB 23A(P909) |
| 24   |              | A-4455-CP 24 A(208) | 22-18-2246   | A-4455-CY 24 A(565) | 22-02-7243   | A-4455-CY 24A(P909) | 22-15-4248   | A-4455-CB 24A(P909) |
| 25   |              | A-4455-CP 25 A(208) | 22-18-2256   | A-4455-CY 25 A(565) | 22-02-7253   | A-4455-CY 25A(P909) | 22-15-4258   | A-4455-CB 25A(P909) |

|                  |                             |  |                |
|------------------|-----------------------------|--|----------------|
| REV:             | <b>ECR/ECN INFORMATION:</b> | TITLE:                                     | SHEET No.      |
| <b>D14</b>       | EC No.:                     | <b>KK 100 PCB ASSY<br/>4455 SERIES DWG</b> | <b>- 10 -</b>  |
|                  | DATE: <b>3/4/2020</b>       |  |                |
| DOCUMENT NUMBER: | CREATED / REVISED BY:       | CHECKED BY:                                | APPROVED BY:   |
| <b>SDA-4455</b>  | <b>SS06</b>                 | <b>SS06</b>                                | <b>ISHWARG</b> |



## KK 100 PCB ASSY 2-25 CKT 4455 SERIES

| Ckts | Assy Proc: TOP ENTRY |                     | Assy Proc: TOP ENTRY |                     | Assy Proc: TOP ENTRY |                     | Assy Proc: TOP ENTRY     |                     |
|------|----------------------|---------------------|----------------------|---------------------|----------------------|---------------------|--------------------------|---------------------|
|      | Material No          | Engineer Number     | Material No          | Engineer Number     | Material No          | Engineer Number     | Material No              | Engineer Number     |
| 2    | 22-65-3020           | A-4455-CR02A(P909)  | 22-18-2024           | A-4455-CZ02B(228)   | 22-18-7023           | A-4455-CY02A(208)   | 22-18-7021               | A-4455-CY02B(228)   |
| 3    | 22-65-3030           | A-4455-CR 03A(P909) | 22-18-2034           | A-4455-CZ 03 B(228) | 22-18-7033           | A-4455-CY 03 A(208) | 22-18-7031<br>38-00-1478 | A-4455-CY 03 B(228) |
| 4    | 22-65-3040           | A-4455-CR 04A(P909) | 22-18-2044           | A-4455-CZ 04 B(228) | 22-18-7043           | A-4455-CY 04 A(208) | 22-18-7041               | A-4455-CY 04 B(228) |
| 5    | 22-65-3050           | A-4455-CR 05A(P909) | 22-18-2054           | A-4455-CZ 05 B(228) | 22-18-7053           | A-4455-CY 05 A(208) | 22-18-7051               | A-4455-CY 05 B(228) |
| 6    | 22-65-3060           | A-4455-CR 06A(P909) | 22-18-2064           | A-4455-CZ 06 B(228) | 22-18-7063           | A-4455-CY 06 A(208) | 22-18-7061               | A-4455-CY 06 B(228) |
| 7    | 22-65-3070           | A-4455-CR 07A(P909) | 22-18-2074           | A-4455-CZ 07 B(228) | 22-18-7073           | A-4455-CY 07 A(208) | 22-18-7071               | A-4455-CY 07 B(228) |
| 8    | 22-65-3080           | A-4455-CR 08A(P909) | 22-18-2084           | A-4455-CZ 08 B(228) | 22-18-7083           | A-4455-CY 08 A(208) | 22-18-7081               | A-4455-CY 08 B(228) |
| 9    | 22-65-3090           | A-4455-CR 09A(P909) | 22-18-2094           | A-4455-CZ 09 B(228) | 22-18-7093           | A-4455-CY 09 A(208) | 22-18-7091               | A-4455-CY 09 B(228) |
| 10   | 22-65-3100           | A-4455-CR 10A(P909) | 22-18-2104           | A-4455-CZ 10 B(228) | 22-18-7103           | A-4455-CY 10 A(208) | 22-18-7101               | A-4455-CY 10 B(228) |
| 11   | 22-65-3110           | A-4455-CR 11A(P909) | 22-18-2114           | A-4455-CZ 11 B(228) | 22-18-7113           | A-4455-CY 11 A(208) | 22-18-7111               | A-4455-CY 11 B(228) |
| 12   | 22-65-3120           | A-4455-CR 12A(P909) | 22-18-2124           | A-4455-CZ 12 B(228) | 22-18-7123           | A-4455-CY 12 A(208) | 22-18-7121               | A-4455-CY 12 B(228) |
| 13   | 22-65-3130           | A-4455-CR 13A(P909) | 22-18-2134           | A-4455-CZ 13 B(228) | 22-18-7133           | A-4455-CY 13 A(208) | 22-18-7131               | A-4455-CY 13 B(228) |
| 14   | 22-65-3140           | A-4455-CR 14A(P909) | 22-18-2144           | A-4455-CZ 14 B(228) | 22-18-7143           | A-4455-CY 14 A(208) | 22-18-7141               | A-4455-CY 14 B(228) |
| 15   | 22-65-3150           | A-4455-CR 15A(P909) | 22-18-2154           | A-4455-CZ 15 B(228) | 22-18-7153           | A-4455-CY 15 A(208) | 22-18-7151               | A-4455-CY 15 B(228) |
| 16   | 22-65-3160           | A-4455-CR 16A(P909) | 22-18-2164           | A-4455-CZ 16 B(228) | 22-18-7163           | A-4455-CY 16 A(208) | 22-18-7161               | A-4455-CY 16 B(228) |
| 17   | 22-65-3170           | A-4455-CR 17A(P909) | 22-18-2174           | A-4455-CZ 17 B(228) | 22-18-7173           | A-4455-CY 17 A(208) | 22-18-7171               | A-4455-CY 17 B(228) |
| 18   | 22-65-3180           | A-4455-CR 18A(P909) | 22-18-2184           | A-4455-CZ 18 B(228) | 22-18-7183           | A-4455-CY 18 A(208) | 22-18-7181               | A-4455-CY 18 B(228) |
| 19   | 22-65-3190           | A-4455-CR 19A(P909) | 22-18-2194           | A-4455-CZ 19 B(228) | 22-18-7193           | A-4455-CY 19 A(208) | 22-18-7191               | A-4455-CY 19 B(228) |
| 20   | 22-65-3200           | A-4455-CR 20A(P909) | 22-18-2204           | A-4455-CZ 20 B(228) | 22-18-7203           | A-4455-CY 20 A(208) | 22-18-7201               | A-4455-CY 20 B(228) |
| 21   | 22-65-3210           | A-4455-CR 21A(P909) | 22-18-2214           | A-4455-CZ 21 B(228) | 22-18-7213           | A-4455-CY 21 A(208) | 22-18-7211               | A-4455-CY 21 B(228) |
| 22   | 22-65-3220           | A-4455-CR 22A(P909) | 22-18-2224           | A-4455-CZ 22 B(228) | 22-18-7223           | A-4455-CY 22 A(208) | 22-18-7221               | A-4455-CY 22 B(228) |
| 23   | 22-65-3230           | A-4455-CR 23A(P909) | 22-18-2234           | A-4455-CZ 23 B(228) | 22-18-7233           | A-4455-CY 23 A(208) | 22-18-7231               | A-4455-CY 23 B(228) |
| 24   | 22-65-3240           | A-4455-CR 24A(P909) | 22-18-2244           | A-4455-CZ 24 B(228) | 22-18-7243           | A-4455-CY 24 A(208) | 22-18-7241               | A-4455-CY 24 B(228) |
| 25   | 22-65-3250           | A-4455-CR 25A(P909) | 22-18-2254           | A-4455-CZ 25 B(228) | 22-18-7253           | A-4455-CY 25 A(208) | 22-18-7251               | A-4455-CY 25 B(228) |

|                         |                             |  |                    |
|-------------------------|-----------------------------|--|--------------------|
| REV:                    | <b>ECR/ECN INFORMATION:</b> | <b>TITLE:</b>                              | <b>SHEET No.</b>   |
| <b>D14</b>              | EC No.:                     | <b>KK 100 PCB ASSY<br/>4455 SERIES DWG</b> | <b>- 11 -</b>      |
|                         | DATE: <b>3/4/2020</b>       |  |                    |
| <b>DOCUMENT NUMBER:</b> |                             | <b>CREATED / REVISED BY:</b>               | <b>CHECKED BY:</b> |
| <b>SDA-4455</b>         |                             | <b>SS06</b>                                | <b>SS06</b>        |
|                         |                             | <b>APPROVED BY:</b>                        |                    |
|                         |                             | <b>ISHWARG</b>                             |                    |



## KK 100 PCB ASSY 2-25 CKT 4455 SERIES

|      | Assy Proc:   | RIGHT ANGLE         | Assy Proc:   | BOTTOM ENTRY        | Assy Proc:   | RIGHT ANGLE          | Assy Proc:   | RIGHT ANGLE         |
|------|--------------|---------------------|--------------|---------------------|--------------|----------------------|--------------|---------------------|
|      | Hooks Cut:   | NO                  | Hooks Cut:   | NO                  | Hooks Cut:   | NO                   | Hooks Cut:   | NO                  |
|      | Housing No:  | 4455-N              | Housing No:  | 4455-N2             | Housing No:  | 4455-AN              | Housing No:  | 4455-AN             |
|      | Terminal No: | 6516-5C(P909)       | Terminal No: | 6516-6C(P909)       | Terminal No: | 6516-4(P909)         | Terminal No: | 4316-4(565)         |
|      | Dim C:       | 3.35±1.00/.132±.039 | Dim C:       | 3.61±1.00/.142±.039 | Dim C:       | 3.35 / .132          | Dim C:       | 3.35 / .132         |
|      | Plating:     | P909                | Plating:     | P909                | Plating:     | P909                 | Plating:     | 565                 |
|      | Packaging:   | PK-44646-001        | Packaging:   | PK-44646-001        | Packaging:   | PK-44646-001         | Packaging:   | PK-44646-001        |
|      | Voids:       | NO                  | Voids:       | NO                  | Voids:       | NO                   | Voids:       | NO                  |
|      |              |                     |              |                     |              |                      |              |                     |
| Ckts | Material No  | Engineer Number     | Material No  | Engineer Number     | Material No  | Engineer Number      | Material No  | Engineer Number     |
| 2    | 38-00-1332   | A-4455-AZ02C(P909)  | 38-00-1392   | A-4455-BH02F(P909)  |              |                      |              |                     |
| 3    | 38-00-1333   | A-4455-AZ03C(P909)  | 38-00-1393   | A-4455-BH03F(P909)  |              |                      |              |                     |
| 4    | 38-00-1334   | A-4455-AZ04C(P909)  | 38-00-1394   | A-4455-BH04F(P909)  |              |                      |              |                     |
| 5    | 38-00-1335   | A-4455-AZ05C(P909)  | 38-00-1395   | A-4455-BH05F(P909)  |              |                      |              |                     |
| 6    | 38-00-1336   | A-4455-AZ06C(P909)  | 38-00-1396   | A-4455-BH06F(P909)  |              |                      |              |                     |
| 7    | 38-00-1337   | A-4455-AZ07C(P909)  | 38-00-1397   | A-4455-BH07F(P909)  | 22-14-2079   | A-4455-AA07B(P909)   | 22-14-2077   | A-4455-AA07A(565)   |
| 8    | 38-00-1338   | A-4455-AZ08C(P909)  | 38-00-1398   | A-4455-BH08F(P909)  | 22-14-2089   | A-4455-AA 08 B(P909) | 22-14-2087   | A-4455-AA 08 A(565) |
| 9    | 38-00-1339   | A-4455-AZ09C(P909)  | 38-00-1399   | A-4455-BH09F(P909)  | 22-14-2099   | A-4455-AA 09 B(P909) | 22-14-2097   | A-4455-AA 09 A(565) |
| 10   | 38-00-1340   | A-4455-AZ10C(P909)  | 38-00-1400   | A-4455-BH10F(P909)  | 22-14-2109   | A-4455-AA 10 B(P909) | 22-14-2107   | A-4455-AA 10 A(565) |
| 11   | 38-00-1341   | A-4455-AZ11C(P909)  | 38-00-1401   | A-4455-BH11F(P909)  | 22-14-2119   | A-4455-AA 11 B(P909) | 22-14-2117   | A-4455-AA 11 A(565) |
| 12   | 38-00-1342   | A-4455-AZ12C(P909)  | 38-00-1402   | A-4455-BH12F(P909)  | 22-14-2129   | A-4455-AA 12 B(P909) | 22-14-2127   | A-4455-AA 12 A(565) |
| 13   | 38-00-1343   | A-4455-AZ13C(P909)  | 38-00-1403   | A-4455-BH13F(P909)  | 22-14-2139   | A-4455-AA 13 B(P909) | 22-14-2137   | A-4455-AA 13 A(565) |
| 14   | 38-00-1344   | A-4455-AZ14C(P909)  | 38-00-1404   | A-4455-BH14F(P909)  | 22-14-2149   | A-4455-AA 14 B(P909) | 22-14-2147   | A-4455-AA 14 A(565) |
| 15   | 38-00-1345   | A-4455-AZ15C(P909)  | 38-00-1405   | A-4455-BH15F(P909)  | 22-14-2159   | A-4455-AA 15 B(P909) | 22-14-2157   | A-4455-AA 15 A(565) |
| 16   | 38-00-1346   | A-4455-AZ16C(P909)  | 38-00-1406   | A-4455-BH16F(P909)  | 22-14-2169   | A-4455-AA 16 B(P909) | 22-14-2167   | A-4455-AA 16 A(565) |
| 17   | 38-00-1347   | A-4455-AZ17C(P909)  | 38-00-1407   | A-4455-BH17F(P909)  | 22-14-2179   | A-4455-AA 17 B(P909) | 22-14-2177   | A-4455-AA 17 A(565) |
| 18   | 38-00-1348   | A-4455-AZ18C(P909)  | 38-00-1408   | A-4455-BH18F(P909)  | 22-14-2189   | A-4455-AA 18 B(P909) | 22-14-2187   | A-4455-AA 18 A(565) |
| 19   | 38-00-1349   | A-4455-AZ19C(P909)  | 38-00-1409   | A-4455-BH19F(P909)  | 22-14-2199   | A-4455-AA 19 B(P909) | 22-14-2197   | A-4455-AA 19 A(565) |
| 20   | 38-00-1350   | A-4455-AZ20C(P909)  | 38-00-1410   | A-4455-BH20F(P909)  | 22-14-2209   | A-4455-AA 20 B(P909) | 22-14-2207   | A-4455-AA 20 A(565) |
| 21   | 38-00-1351   | A-4455-AZ21C(P909)  | 38-00-1411   | A-4455-BH21F(P909)  | 22-14-2219   | A-4455-AA 21 B(P909) | 22-14-2217   | A-4455-AA 21 A(565) |
| 22   | 38-00-1352   | A-4455-AZ22C(P909)  | 38-00-1412   | A-4455-BH22F(P909)  | 22-14-2229   | A-4455-AA 22 B(P909) | 22-14-2227   | A-4455-AA 22 A(565) |
| 23   | 38-00-1353   | A-4455-AZ23C(P909)  | 38-00-1413   | A-4455-BH23F(P909)  | 22-14-2239   | A-4455-AA 23 B(P909) | 22-14-2237   | A-4455-AA 23 A(565) |
| 24   | 38-00-1354   | A-4455-AZ24C(P909)  | 38-00-1414   | A-4455-BH24F(P909)  | 22-14-2249   | A-4455-AA 24 B(P909) | 22-14-2247   | A-4455-AA 24 A(565) |
| 25   | 38-00-1355   | A-4455-AZ25C(P909)  | 38-00-1415   | A-4455-BH25F(P909)  | 22-14-2259   | A-4455-AA 25 B(P909) | 22-14-2257   | A-4455-AA 25 A(565) |

|                  |                             |  |                |
|------------------|-----------------------------|--|----------------|
| REV:             | <b>ECR/ECN INFORMATION:</b> | TITLE:                                     | SHEET No.      |
| <b>D14</b>       | EC No.:                     | <b>KK 100 PCB ASSY<br/>4455 SERIES DWG</b> | <b>- 12 -</b>  |
|                  | DATE: <b>3/4/2020</b>       |  |                |
| DOCUMENT NUMBER: | CREATED / REVISED BY:       | CHECKED BY:                                | APPROVED BY:   |
| <b>SDA-4455</b>  | <b>SS06</b>                 | <b>SS06</b>                                | <b>ISHWARG</b> |



## KK 100 PCB ASSY 2-25 CKT 4455 SERIES

|      | Assy Proc:   | RIGHT ANGLE          | Assy Proc:   | RIGHT ANGLE         | Assy Proc:   | TOP ENTRY           | Assy Proc:   | TOP ENTRY            |
|------|--------------|----------------------|--------------|---------------------|--------------|---------------------|--------------|----------------------|
|      | Hooks Cut:   | NO                   | Hooks Cut:   | NO                  | Hooks Cut:   | NO                  | Hooks Cut:   | YES                  |
|      | Housing No:  | 4455-AN              | Housing No:  | 4455-BN             | Housing No:  | 4455-N              | Housing No:  | 4455-N-02            |
|      | Terminal No: | 4316-4A(P909)        | Terminal No: | 4316-4(565)         | Terminal No: | 6516-5C(P909)       | Terminal No: | 4316-4(P909)         |
|      | Dim C:       | 3.35 / .132          | Dim C:       | 3.35 / .132         | Dim C:       | 3.35±1.00/.132±.039 | Dim C:       | 3.35 / .132          |
|      | Plating:     | P909                 | Plating:     | 565                 | Plating:     | P909                | Plating:     | P909                 |
|      | Packaging:   | PK-44646-001         | Packaging:   | PK-44646-002        | Packaging:   | PK-44646-001        | Packaging:   | PK-44646-003         |
|      | Voids:       | NO                   | Voids:       | NO                  | Voids:       | NO                  | Voids:       | YES IN CKT 2         |
|      |              |                      |              |                     |              |                     |              |                      |
| Ckts | Material No  | Engineer Number      | Material No  | Engineer Number     | Material No  | Engineer Number     | Material No  | Engineer Number      |
| 2    |              |                      | 22-16-3028   | A-4455-AB02A(565)   | 38-00-1422   | A-4455-CZ02C(P909)  |              |                      |
| 3    |              |                      | 22-16-3038   | A-4455-AB 03 A(565) | 38-00-1423   | A-4455-CZ03C(P909)  |              |                      |
| 4    |              |                      | 22-16-3048   | A-4455-AB 04 A(565) | 38-00-1424   | A-4455-CZ04C(P909)  |              |                      |
| 5    |              |                      | 22-16-3058   | A-4455-AB 05 A(565) | 38-00-1425   | A-4455-CZ05C(P909)  |              |                      |
| 6    |              |                      | 22-16-3068   | A-4455-AB 06 A(565) | 38-00-1426   | A-4455-CZ06C(P909)  | 22-02-3068   | A-4455-CW06A(P909)-2 |
| 7    | 22-14-3617   | A-4455-AA07T(P909)   | 22-16-3078   | A-4455-AB 07 A(565) | 38-00-1427   | A-4455-CZ07C(P909)  | 50-29-0004   | A-4455-CW07A(P909)-2 |
| 8    | 22-14-3618   | A-4455-AA 08 T(P909) | 22-16-3088   | A-4455-AB 08 A(565) | 38-00-1428   | A-4455-CZ08C(P909)  |              |                      |
| 9    | 22-14-3619   | A-4455-AA 09 T(P909) | 22-16-3098   | A-4455-AB 09 A(565) | 38-00-1429   | A-4455-CZ09C(P909)  |              |                      |
| 10   | 22-14-3711   | A-4455-AA 10 T(P909) | 22-16-3108   | A-4455-AB 10 A(565) | 38-00-1430   | A-4455-CZ10C(P909)  |              |                      |
| 11   | 22-14-3712   | A-4455-AA 11 T(P909) | 22-16-3118   | A-4455-AB 11 A(565) | 38-00-1431   | A-4455-CZ11C(P909)  |              |                      |
| 12   | 22-14-3713   | A-4455-AA 12 T(P909) | 22-16-3128   | A-4455-AB 12 A(565) | 38-00-1432   | A-4455-CZ12C(P909)  |              |                      |
| 13   | 22-14-3714   | A-4455-AA 13 T(P909) | 22-16-3138   | A-4455-AB 13 A(565) | 38-00-1433   | A-4455-CZ13C(P909)  |              |                      |
| 14   | 22-14-3715   | A-4455-AA 14 T(P909) | 22-16-3148   | A-4455-AB 14 A(565) | 38-00-1434   | A-4455-CZ14C(P909)  |              |                      |
| 15   | 22-14-3716   | A-4455-AA 15 T(P909) | 22-16-3158   | A-4455-AB 15 A(565) | 38-00-1435   | A-4455-CZ15C(P909)  |              |                      |
| 16   | 22-14-3717   | A-4455-AA 16 T(P909) | 22-16-3168   | A-4455-AB 16 A(565) | 38-00-1436   | A-4455-CZ16C(P909)  |              |                      |
| 17   | 22-14-3718   | A-4455-AA 17 T(P909) | 22-16-3178   | A-4455-AB 17 A(565) | 38-00-1437   | A-4455-CZ17C(P909)  |              |                      |
| 18   | 22-14-3719   | A-4455-AA 18 T(P909) | 22-16-3188   | A-4455-AB 18 A(565) | 38-00-1438   | A-4455-CZ18C(P909)  |              |                      |
| 19   | 22-14-3811   | A-4455-AA 19 T(P909) | 22-16-3198   | A-4455-AB 19 A(565) | 38-00-1439   | A-4455-CZ19C(P909)  |              |                      |
| 20   | 22-14-3812   | A-4455-AA 20 T(P909) | 22-16-3208   | A-4455-AB 20 A(565) | 38-00-1440   | A-4455-CZ20C(P909)  |              |                      |
| 21   | 22-14-3813   | A-4455-AA 21 T(P909) | 22-16-3218   | A-4455-AB 21 A(565) | 38-00-1441   | A-4455-CZ21C(P909)  |              |                      |
| 22   | 22-14-3814   | A-4455-AA 22 T(P909) | 22-16-3228   | A-4455-AB 22 A(565) | 38-00-1442   | A-4455-CZ22C(P909)  |              |                      |
| 23   | 22-14-3815   | A-4455-AA 23 T(P909) | 22-16-3238   | A-4455-AB 23 A(565) | 38-00-1443   | A-4455-CZ23C(P909)  |              |                      |
| 24   | 22-14-3816   | A-4455-AA 24 T(P909) | 22-16-3248   | A-4455-AB 24 A(565) | 38-00-1444   | A-4455-CZ24C(P909)  |              |                      |
| 25   | 22-14-3817   | A-4455-AA 25 T(P909) | 22-16-3258   | A-4455-AB 25 A(565) | 38-00-1445   | A-4455-CZ25C(P909)  |              |                      |

|                  |                             |  |                |
|------------------|-----------------------------|--|----------------|
| REV:             | <b>ECR/ECN INFORMATION:</b> | TITLE:                                     | SHEET No.      |
| <b>D14</b>       | EC No.:                     | <b>KK 100 PCB ASSY<br/>4455 SERIES DWG</b> | <b>- 13 -</b>  |
|                  | DATE: <b>3/4/2020</b>       |  |                |
| DOCUMENT NUMBER: | CREATED / REVISED BY:       | CHECKED BY:                                | APPROVED BY:   |
| <b>SDA-4455</b>  | <b>SS06</b>                 | <b>SS06</b>                                | <b>ISHWARG</b> |



## KK 100 PCB ASSY 2-25 CKT 4455 SERIES

| Assy Proc:   | TOP ENTRY    | Assy Proc:   | TOP ENTRY    | Assy Proc:   | BOTTOM ENTRY  | Assy Proc:   | BOTTOM ENTRY         |
|--------------|--------------|--------------|--------------|--------------|---------------|--------------|----------------------|
| Hooks Cut:   | YES          | Hooks Cut:   | YES          | Hooks Cut:   | NO            | Hooks Cut:   | NO                   |
| Housing No:  | 4455-N       | Housing No:  | 4455-N       | Housing No:  | 4455-N2       | Housing No:  | 4455-N2              |
| Terminal No: | 6516-4(P909) | Terminal No: | 4316-4(P909) | Terminal No: | 4316-3B(P909) | Terminal No: | 4316-3B(208)         |
| Dim C:       | 3.35 / .132  | Dim C:       | 3.35 / .132  | Dim C:       | .132 / 3.35   | Dim C:       | .132 / 3.35          |
| Plating:     | P909         | Plating:     | P909         | Plating:     | P909          | Plating:     | 208                  |
| Packaging:   | PK-44646-003 | Packaging:   | PK-44646-003 | Packaging:   | PK-44646-001  | Packaging:   | PK-44646-001         |
| Voids:       | NO           | Voids:       | YES IN CKT 2 | Voids:       | YES IN CKT 10 | Voids:       | 2,3,4,6,7,8,10,11,12 |

| Ckts | Material No | Engineer Number     | Material No | Engineer Number      | Material No | Engineer Number       | Material No | Engineer Number      |
|------|-------------|---------------------|-------------|----------------------|-------------|-----------------------|-------------|----------------------|
| 2    |             | A-4455-CY02B(P909)  |             |                      |             |                       |             |                      |
| 3    |             | A-4455-CY 03B(P909) |             |                      |             |                       |             |                      |
| 4    |             | A-4455-CY 04B(P909) |             |                      |             |                       |             |                      |
| 5    | 50-29-1553  | A-4455-CY 05B(P909) |             |                      |             |                       |             |                      |
| 6    | 50-29-1554  | A-4455-CY 06B(P909) | 22-15-5065  | A-4455-CY06A(P909)-2 |             |                       |             |                      |
| 7    |             | A-4455-CY 07B(P909) |             |                      |             |                       |             |                      |
| 8    |             | A-4455-CY 08B(P909) |             |                      |             |                       |             |                      |
| 9    |             | A-4455-CY 09B(P909) |             |                      |             |                       |             |                      |
| 10   |             | A-4455-CY 10B(P909) |             |                      |             |                       |             |                      |
| 11   |             | A-4455-CY 11B(P909) |             |                      | 50-36-1881  | A-4455-BH11D(P909)-10 |             |                      |
| 12   |             | A-4455-CY 12B(P909) |             |                      |             |                       |             |                      |
| 13   |             | A-4455-CY 13B(P909) |             |                      |             |                       | 26-01-3099  | A-4455-BH13D(208)-51 |
| 14   |             | A-4455-CY 14B(P909) |             |                      |             |                       |             |                      |
| 15   |             | A-4455-CY 15B(P909) |             |                      |             |                       |             |                      |
| 16   |             | A-4455-CY 16B(P909) |             |                      |             |                       |             |                      |
| 17   |             | A-4455-CY 17B(P909) |             |                      |             |                       |             |                      |
| 18   |             | A-4455-CY 18B(P909) |             |                      |             |                       |             |                      |
| 19   |             | A-4455-CY 19B(P909) |             |                      |             |                       |             |                      |
| 20   |             | A-4455-CY 20B(P909) |             |                      |             |                       |             |                      |
| 21   |             | A-4455-CY 21B(P909) |             |                      |             |                       |             |                      |
| 22   |             | A-4455-CY 22B(P909) |             |                      |             |                       |             |                      |
| 23   |             | A-4455-CY 23B(P909) |             |                      |             |                       |             |                      |
| 24   |             | A-4455-CY 24B(P909) |             |                      |             |                       |             |                      |
| 25   |             | A-4455-CY 25B(P909) |             |                      |             |                       |             |                      |

|                  |                             |  |                |
|------------------|-----------------------------|--|----------------|
| REV:             | <b>ECR/ECN INFORMATION:</b> | TITLE:                                     | SHEET No.      |
| <b>D14</b>       | EC No.:                     | <b>KK 100 PCB ASSY<br/>4455 SERIES DWG</b> | <b>- 14 -</b>  |
|                  | DATE: <b>3/4/2020</b>       |  |                |
| DOCUMENT NUMBER: | CREATED / REVISED BY:       | CHECKED BY:                                | APPROVED BY:   |
| <b>SDA-4455</b>  | <b>SS06</b>                 | <b>SS06</b>                                | <b>ISHWARG</b> |



## KK 100 PCB ASSY 2-25 CKT 4455 SERIES

|      | Assy Proc:   | RIGHT ANGLE           | Assy Proc:   | TOP ENTRY          | Assy Proc:   | TOP ENTRY           | Assy Proc:   | TOP ENTRY           |
|------|--------------|-----------------------|--------------|--------------------|--------------|---------------------|--------------|---------------------|
|      | Hooks Cut:   | NO                    | Hooks Cut:   | YES                | Hooks Cut:   | YES                 | Hooks Cut:   | YES                 |
|      | Housing No:  | 4455-BN               | Housing No:  | 4455-BN            | Housing No:  | 4455-NR             | Housing No:  | 4455-N              |
|      | Terminal No: | 4316-4(P909)          | Terminal No: | 4316-4(P909)       | Terminal No: | 4316-4(P909)        | Terminal No: | 4316-4(P909)        |
|      | Dim C:       | 3.35 / .132           | Dim C:       | 3.35 / .132        | Dim C:       | 3.35 / .132         | Dim C:       | 3.35 / .132         |
|      | Plating:     | P909                  | Plating:     | P909               | Plating:     | P909                | Plating:     | P909                |
|      | Packaging:   | PK-44646-002          | Packaging:   | PK-44646-006       | Packaging:   | PK-44646-003        | Packaging:   | 44551000-PK         |
|      | Voids:       | 3,6,12,15             | Voids:       | NO                 | Voids:       | NO                  | Voids:       | NO                  |
|      |              |                       |              |                    |              |                     |              |                     |
| Ckts | Material No  | Engineer Number       | Material No  | Engineer Number    | Material No  | Engineer Number     | Material No  | Engineer Number     |
| 2    |              |                       |              |                    |              |                     |              |                     |
| 3    |              |                       | 46999-0585   | A-4455-CG03A(P909) |              |                     | 22-02-2031   | A-4455-CY 03A(P909) |
| 4    |              |                       | 46999-0583   | A-4455-CG04A(P909) |              |                     |              |                     |
| 5    |              |                       |              |                    |              |                     |              |                     |
| 6    |              |                       | 46999-0584   | A-4455-CG06A(P909) |              |                     |              |                     |
| 7    |              |                       |              |                    |              |                     |              |                     |
| 8    |              |                       |              |                    | 46999-0599   | A-4455-CP 08A(P909) |              |                     |
| 9    |              |                       |              |                    |              |                     |              |                     |
| 10   |              |                       |              |                    |              |                     |              |                     |
| 11   |              |                       |              |                    |              |                     |              |                     |
| 12   |              |                       |              |                    |              |                     |              |                     |
| 13   |              |                       |              |                    |              |                     |              |                     |
| 14   |              |                       | 46999-0586   | A-4455-CG14A(P909) |              |                     |              |                     |
| 15   |              |                       |              |                    |              |                     |              |                     |
| 16   |              |                       |              |                    |              |                     |              |                     |
| 17   | 46999-0582   | A-4455-AB17A(P909)-51 |              |                    |              |                     |              |                     |
| 18   |              |                       |              |                    |              |                     |              |                     |
| 19   |              |                       |              |                    |              |                     |              |                     |
| 20   |              |                       |              |                    |              |                     |              |                     |
| 21   |              |                       |              |                    |              |                     |              |                     |
| 22   |              |                       |              |                    |              |                     |              |                     |
| 23   |              |                       |              |                    |              |                     |              |                     |
| 24   |              |                       |              |                    |              |                     |              |                     |
| 25   |              |                       |              |                    |              |                     |              |                     |

|                  |                             |  |               |
|------------------|-----------------------------|--|---------------|
| REV:             | <b>ECR/ECN INFORMATION:</b> | TITLE:                                     | SHEET No.     |
| <b>D14</b>       | EC No.:                     | <b>KK 100 PCB ASSY<br/>4455 SERIES DWG</b> | <b>- 15 -</b> |
|                  | DATE: <b>3/4/2020</b>       |  |               |
| DOCUMENT NUMBER: |                             | CREATED / REVISED BY:                      | CHECKED BY:   |
| <b>SDA-4455</b>  |                             | <b>SS06</b>                                | <b>SS06</b>   |
|                  |                             | APPROVED BY:                               |               |
|                  |                             | <b>ISHWARG</b>                             |               |

## X-ON Electronics

Largest Supplier of Electrical and Electronic Components

*Click to view similar products for [Headers & Wire Housings](#) category:*

*Click to view products by [Molex](#) manufacturer:*

Other Similar products are found below :

[892-18-020-10-001101](#) [58102-G61-06LF](#) [582553-1](#) [0009485154](#) [009176003701906](#) [0050291907](#) [LY20-4P-DT1-P1E-BR](#) [02.125.8002.8](#)  
[609-3404](#) [61062-3](#) [622-0430](#) [622-3653LF](#) [63453-116](#) [636-1030](#) [636-1427](#) [636-3427](#) [636-4007](#) [641938-9](#) [641991-4](#) [644827-2](#) [65817-010LF](#)  
[65817-015LF](#) [65863-015LF](#) [66207-023LF](#) [67095-007LF](#) [67601157](#) [68648-049](#) [70.362.1628.0](#) [70-4210](#) [70-4226B](#) [70-4853B](#) [707-5020](#) [707-](#)  
[5028](#) [71.350.2428.0](#) [71918-208LF](#) [71961-016LF](#) [733-134](#) [733-162](#) [754199-000](#) [760-3052](#) [787-8014-00](#) [79531-3000](#) [FCN-360C032-B](#) [FCN-](#)  
[367T-T012/H](#) [FCN-723D010/2](#) [80.063.4001.1](#) [800-90-001-10-001000](#) [800-90-010-10-002000](#) [801-43-002-10-013000](#) [801-43-006-10-002000](#)