

PLEASE CHECK WWW.MOLEX.COM FOR LATEST PART INFORMATION

Part Number: [0353120560](#)
Status: **Active**
Description: 2.50mm Pitch Header, Vertical, Shrouded, with Positive Lock, 5 Circuits, PA Polyamide (Nylon) 6/6, Glass-filled, Natural

Documents:

3D Model	Packaging Specification PK-35312-013-001 (PDF)
3D Model (PDF)	Packaging Specification PK-35312-014-001 (PDF)
Drawing (PDF)	RoHS Certificate of Compliance (PDF)
Product Specification PS-35155-002-001 (PDF)	

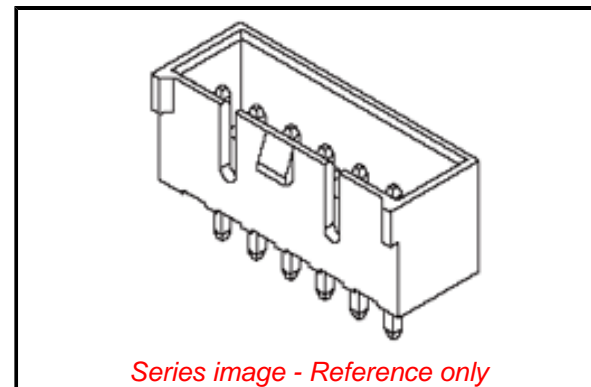

Agency Certification

CSA	LR19980
UL	E29179

General

Product Family	PCB Headers
Series	35312
Application	Signal, Wire-to-Board
Product Name	N/A
UPC	822348799244

Physical

Breakaway	No
Circuits (Loaded)	5
Circuits (maximum)	5
Color - Resin	Natural
Durability (mating cycles max)	30
First Mate / Last Break	No
Flammability	94V-0
Glow-Wire Capable	No
Guide to Mating Part	No
Keying to Mating Part	None
Lock to Mating Part	Yes
Material - Plating Mating	Tin
Material - Plating Termination	Tin
Material - Resin	Nylon
Net Weight	0.526/g
Number of Rows	1
Orientation	Vertical
PC Tail Length	3.40mm
PCB Locator	No
PCB Retention	None
PCB Thickness - Recommended	1.60mm
Packaging Type	Bag
Pitch - Mating Interface	2.50mm
Pitch - Termination Interface	2.50mm
Plating min - Mating	5.080µm
Plating min - Termination	5.080µm
Polarized to PCB	No
Shrouded	Partial
Stackable	No
Surface Mount Compatible (SMC)	No
Temperature Range - Operating	-40° to +105°C
Termination Interface: Style	Through Hole

Electrical

EU ELV

Not Relevant

EU RoHS

Compliant

REACH SVHC

Not Contained Per -
D(2021)4569-DC (8
July 2021)

Halogen-Free

Status

Not Low-Halogen

For more information, please visit [Contact US](#)

China ROHS

ELV

RoHS Phthalates

China RoHS

Green Image

Not Relevant

Not Contained

Search Parts in this Series

[35312](#) Series

Mates With

Wire-to-Wire and Wire-to-Board Housing
[35572](#) Crimp Housing, [35155](#)

Current - Maximum per Contact 3.0A
Voltage - Maximum 250V

Material Info

Reference - Drawing Numbers

Packaging Specification PK-35312-013-001, PK-35312-014-001
Product Specification PS-35155-002-001
Sales Drawing SD-35312-004-001, SD-35312-005-001

This document was generated on 12/15/2021

PLEASE CHECK WWW.MOLEX.COM FOR LATEST PART INFORMATION

X-ON Electronics

Largest Supplier of Electrical and Electronic Components

Click to view similar products for [Headers & Wire Housings](#) category:

Click to view products by [Molex](#) manufacturer:

Other Similar products are found below :

[892-18-020-10-001101](#) [58102-G61-06LF](#) [582553-1](#) [0009485154](#) [009176003701906](#) [0050291907](#) [LY20-4P-DT1-P1E-BR](#) [02.125.8002.8](#)
[609-3404](#) [61062-3](#) [622-0430](#) [622-3653LF](#) [63453-116](#) [636-1030](#) [636-1427](#) [636-3427](#) [636-4007](#) [641938-9](#) [641991-4](#) [644827-2](#) [65817-010LF](#)
[65817-015LF](#) [65863-015LF](#) [66207-023LF](#) [67095-007LF](#) [67601157](#) [68648-049](#) [70.362.1628.0](#) [70-4210](#) [70-4226B](#) [70-4853B](#) [707-5020](#) [707-5028](#) [71.350.2428.0](#) [71918-208LF](#) [71961-016LF](#) [733-134](#) [733-162](#) [754199-000](#) [760-3052](#) [787-8014-00](#) [79531-3000](#) [FCN-360C032-B](#) [FCN-367T-T012/H](#) [FCN-723D010/2](#) [80.063.4001.1](#) [800-90-001-10-001000](#) [800-90-010-10-002000](#) [801-43-002-10-013000](#) [801-43-006-10-002000](#)