

PLEASE CHECK WWW.MOLEX.COM FOR LATEST PART INFORMATION

Part Number: [0353130560](#)
Status: **Active**
Description: 3.96mm Pitch Header, Vertical, Shrouded, with Positive Lock, 5 Circuits, PA Polyamide (Nylon) 6/6, Glass-filled, Natural

Documents:

| | |
|--------------------------------|--|
| 3D Model | Product Specification PS-35156-004-001 (PDF) |
| 3D Model (PDF) | Packaging Specification PK-35313-001-001 (PDF) |
| Drawing (PDF) | RoHS Certificate of Compliance (PDF) |

Agency Certification

| | |
|-----|---------|
| CSA | LR19980 |
| UL | E29179 |

General

| | |
|----------------|-----------------------|
| Product Family | PCB Headers |
| Series | 35313 |
| Application | Power, Wire-to-Board |
| Product Name | N/A |
| UPC | 822348399918 |

Physical

| | |
|--------------------------------|----------------|
| Breakaway | No |
| Circuits (Loaded) | 5 |
| Circuits (maximum) | 5 |
| Color - Resin | Natural |
| Durability (mating cycles max) | 30 |
| First Mate / Last Break | No |
| Flammability | 94V-0 |
| Glow-Wire Capable | No |
| Guide to Mating Part | No |
| Keying to Mating Part | None |
| Lock to Mating Part | Yes |
| Material - Plating Mating | Tin |
| Material - Plating Termination | Tin |
| Material - Resin | Nylon |
| Net Weight | 1.440/g |
| Number of Rows | 1 |
| Orientation | Vertical |
| PC Tail Length | 3.40mm |
| PCB Locator | No |
| PCB Retention | None |
| PCB Thickness - Recommended | 1.60mm |
| Packaging Type | Bag |
| Pitch - Mating Interface | 3.96mm |
| Pitch - Termination Interface | 3.96mm |
| Plating min - Mating | 5.080µm |
| Plating min - Termination | 5.080µm |
| Polarized to Mating Part | Yes |
| Polarized to PCB | No |
| Shrouded | Partial |
| Stackable | No |
| Temperature Range - Operating | -40° to +105°C |
| Termination Interface: Style | Through Hole |

Electrical

| | |
|-------------------------------|------|
| Current - Maximum per Contact | 7.0A |
|-------------------------------|------|

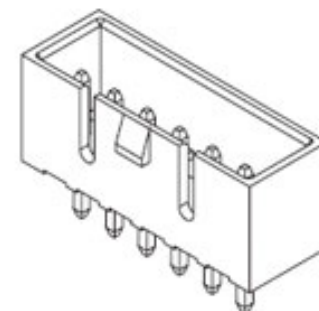

Series image - Reference only

EU ELV

Not Relevant

EU RoHS

Compliant

REACH SVHC

Not Contained Per -
D(2021)4569-DC (8
July 2021)

Halogen-Free

Status

Not Low-Halogen

For more information, please visit [Contact US](#)

China ROHS

ELV

RoHS Phthalates

China RoHS

Green Image

Not Relevant

Not Contained

Search Parts in this Series

[35313 Series](#)

Mates With

[35156 Wire-to-Board Housing](#)

Voltage - Maximum

250V

Material Info

Reference - Drawing Numbers

Packaging Specification

PK-35313-001-001

Product Specification

PS-35156-004-001

This document was generated on 12/14/2021

PLEASE CHECK WWW.MOLEX.COM FOR LATEST PART INFORMATION

X-ON Electronics

Largest Supplier of Electrical and Electronic Components

Click to view similar products for [Headers & Wire Housings](#) category:

Click to view products by [Molex](#) manufacturer:

Other Similar products are found below :

[892-18-020-10-001101](#) [58102-G61-06LF](#) [582553-1](#) [0009485154](#) [009176003701906](#) [0050291907](#) [LY20-4P-DT1-P1E-BR](#) [02.125.8002.8](#)
[609-3404](#) [61062-3](#) [622-0430](#) [622-3653LF](#) [63453-116](#) [636-1030](#) [636-1427](#) [636-3427](#) [636-4007](#) [641938-9](#) [641991-4](#) [644827-2](#) [65817-010LF](#)
[65817-015LF](#) [65863-015LF](#) [66207-023LF](#) [67095-007LF](#) [67601157](#) [68648-049](#) [70.362.1628.0](#) [70-4210](#) [70-4226B](#) [70-4853B](#) [707-5020](#) [707-5028](#) [71.350.2428.0](#) [71918-208LF](#) [71961-016LF](#) [733-134](#) [733-162](#) [754199-000](#) [760-3052](#) [787-8014-00](#) [79531-3000](#) [FCN-360C032-B](#) [FCN-367T-T012/H](#) [FCN-723D010/2](#) [80.063.4001.1](#) [800-90-001-10-001000](#) [800-90-010-10-002000](#) [801-43-002-10-013000](#) [801-43-006-10-002000](#)