

**PLEASE CHECK WWW.MOLEX.COM FOR LATEST PART INFORMATION**

**Part Number:** [0395216007](#)  
**Status:** **Active**  
**Overview:** Eurostyle Terminal Blocks  
**Description:** 5.00mm Pitch Eurostyle Vertical PCB Header, Green Housing, 7 Circuits

**Documents:**

<a href="#">3D Model</a>	<a href="#">Product Specification PS-39500-001-001 (PDF)</a>
<a href="#">3D Model (PDF)</a>	<a href="#">RoHS Certificate of Compliance (PDF)</a>
<a href="#">Drawing (PDF)</a>	

**Agency Certification**

UL E48521

**General**

Product Family	Terminal Blocks
Series	<a href="#">39521</a>
Application	N/A
Component Type	PCB Header
Overview	<a href="#">Eurostyle Terminal Blocks</a>
Product Name	ESE, Eurostyle Pluggable
Type	Euro Block
UPC	822350425094

**Physical**

Circuits (Loaded)	7
Entry Angle	N/A
Lock to Mating Part	Yes
Number of Rows	1
Orientation	Vertical
PC Tail Length	3.90mm
PCB Thickness - Recommended	3.20mm
Panel Mount	No
Pitch - Mating Interface	5.00mm
Pitch - Termination Interface	5.00mm
Polarized to Mating Part	Yes
Shrouded	Closed Ends
Stackable	No
Temperature Range - Operating	-40° to +105°C
Wire Size AWG	N/A

**Electrical**

Current - Maximum per Contact	15.0A
Voltage - Maximum	300V

**Material Info**

**Reference - Drawing Numbers**

Product Specification	PS-39500-001-001
Sales Drawing	SD-39521-002-001

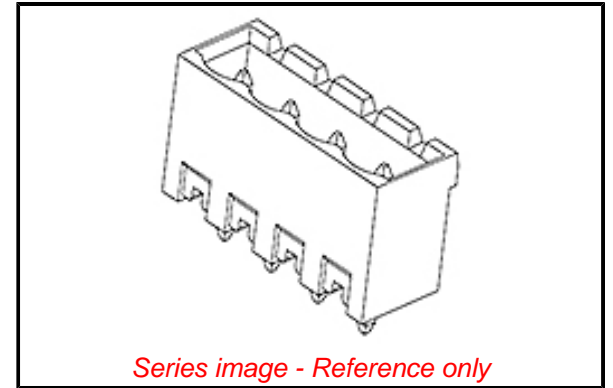

**EU ELV**

**Not Relevant**

**EU RoHS**

**Not Reviewed**

**REACH SVHC**

Not Reviewed

**Halogen-Free**

**Status**

**Not Reviewed**

For more information, please visit [Contact US](#)

China ROHS

Not Relevant

ELV

Not Relevant

RoHS Phthalates

Not Reviewed

**Search Parts in this Series**

[39521](#) Series

**Mates With**

[39520](#) Horizontal Plug, [39523](#) Vertical Plug,  
Most 5.00mm Pitch Industry Standard Plugs

## X-ON Electronics

Largest Supplier of Electrical and Electronic Components

*Click to view similar products for [Pluggable Terminal Blocks](#) category:*

*Click to view products by [Molex](#) manufacturer:*

Other Similar products are found below :

[57.510.0053](#) [MC 1.5/ 6-ST-3.5 GY AU](#) [734-104](#) [734-302](#) [8-141-P](#) [8426620000](#) [860505](#) [860810](#) [GBPACX-12](#) [93.731.4953.0](#) [PV05-5,08-K](#)  
[PVP04-3,50](#) [PVS02-5,00](#) [1-1986160-3](#) [1377680000](#) [1531000000](#) [1546228-5](#) [ELFH16150](#) [ELFP03110](#) [ELFP10210](#) [ELFT06250](#)  
[ELVP03100](#) [1700410](#) [1700425](#) [1702246](#) [1717806](#) [1719600](#) [1734692](#) [1734795](#) [1740291](#) [1752441](#) [1752865](#) [1754144](#) [1760051](#) [1760336](#)  
[1777701](#) [1783410](#) [1800227](#) [1801080](#) [1836888](#) [1848818](#) [1849079](#) [1860870](#) [1876327](#) [1896417](#) [1903096](#) [19346](#) [1946309](#) [1970579](#) [1973592](#)