

PLEASE CHECK WWW.MOLEX.COM FOR LATEST PART INFORMATION

Part Number: [0395221006](#)
Status: **Active**
Overview: Eurostyle Terminal Blocks
Description: 5.00mm Pitch Eurostyle Horizontal PCB Header, 6 Circuits

Documents:

3D Model	Product Specification PS-39500-001-001 (PDF)
3D Model (PDF)	RoHS Certificate of Compliance (PDF)
Drawing (PDF)	

Agency Certification

UL E48521

General

Product Family	Terminal Blocks
Series	39522
Application	N/A
Component Type	PCB Header
Overview	Eurostyle Terminal Blocks
Product Name	ESE, Eurostyle Pluggable
Type	Euro Block
UPC	822350439374

Physical

Circuits (Loaded)	6
Entry Angle	N/A
Lock to Mating Part	Yes
Number of Rows	1
Orientation	Horizontal
PC Tail Length	3.90mm
PCB Thickness - Recommended	3.20mm
Panel Mount	No
Pitch - Mating Interface	5.00mm
Pitch - Termination Interface	5.00mm
Polarized to Mating Part	Yes
Shrouded	Closed Ends
Stackable	No
Temperature Range - Operating	-40° to +105°C
Wire Size AWG	N/A

Electrical

Current - Maximum per Contact	15.0A
Voltage - Maximum	300V

Solder Process Data

Lead-free Process Capability	N/A
------------------------------	-----

Material Info

Reference - Drawing Numbers

Product Specification	PS-39500-001-001
Sales Drawing	SD-39522-002-001

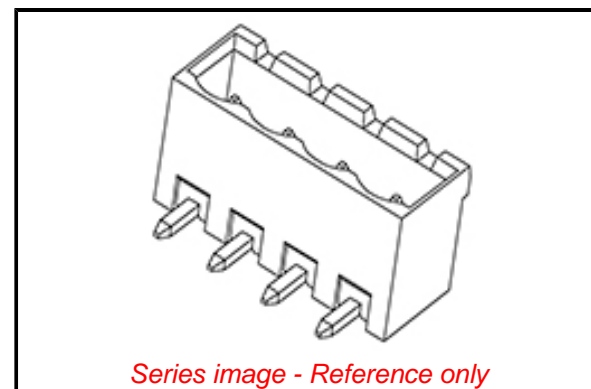

EU ELV

Not Relevant

EU RoHS

Compliant

REACH SVHC

Not Contained Per -
D(2021)4569-DC (8
July 2021)

Halogen-Free

Status

Low-Halogen

For more information, please visit [Contact US](#)

China ROHS

ELV

RoHS Phthalates

China RoHS

Green Image

Not Relevant

Not Contained

Search Parts in this Series

[39522](#) Series

Mates With

[39520](#) Horizontal Plug, [39523](#) Vertical Plug,
Most 5.00mm Pitch Industry Standard Plugs

X-ON Electronics

Largest Supplier of Electrical and Electronic Components

Click to view similar products for [Pluggable Terminal Blocks](#) category:

Click to view products by [Molex](#) manufacturer:

Other Similar products are found below :

[57.510.0053](#) [MC 1.5/ 6-ST-3.5 GY AU](#) [734-104](#) [734-302](#) [8-141-P](#) [8426620000](#) [860505](#) [860810](#) [GBPACX-12](#) [93.731.4953.0](#) [PV05-5,08-K](#)
[PVP04-3,50](#) [PVS02-5,00](#) [1-1986160-3](#) [1377680000](#) [1531000000](#) [1546228-5](#) [ELFH16150](#) [ELFP03110](#) [ELFP10210](#) [ELFT06250](#)
[ELVP03100](#) [1700410](#) [1700425](#) [1702246](#) [1717806](#) [1719600](#) [1734692](#) [1734795](#) [1740291](#) [1752441](#) [1752865](#) [1754144](#) [1760051](#) [1760336](#)
[1777701](#) [1783410](#) [1800227](#) [1801080](#) [1836888](#) [1848818](#) [1849079](#) [1860870](#) [1876327](#) [1896417](#) [1903096](#) [19346](#) [1946309](#) [1970579](#) [1973592](#)