

PLEASE CHECK WWW.MOLEX.COM FOR LATEST PART INFORMATION

Part Number: [0039532174](#)
Status: **Active**
Overview: Easy-On FFC FPC Connectors
Description: 1.25mm Pitch Easy-On FFC/FPC Connector, Through-Hole, Right-Angle, ZIF, Top Contact Style, 17 Circuits

Documents:

3D Model	Product Specification PS-5597-004-001 (PDF)
Drawing (PDF)	Packaging Specification SPK-5597-003-001 (PDF)
3D Model (PDF)	RoHS Certificate of Compliance (PDF)

Agency Certification

UL E29179

General

Product Family	FFC/FPC Connectors
Series	5597
Overview	Easy-On FFC FPC Connectors
Product Name	Easy-On
UPC	822348170241

Physical

Actuator Type	Slider
Circuits (Loaded)	17
Circuits (maximum)	17
Color - Resin	Natural
Contact Position	Top
Durability (mating cycles max)	30
Flammability	94V-0
Mated Height	5.00mm
Material - Metal	Phosphor Bronze
Material - Plating Mating	Tin-Bismuth
Material - Plating Termination	Tin-Bismuth
Material - Resin	Polyester
Net Weight	1479.070/mg
Number of Rows	1
Orientation	Right Angle
PC Tail Length	3.50mm
PCB Locator	No
PCB Mounting	Through Hole
PCB Retention	None
Packaging Type	Tray
Pitch - Mating Interface	1.25mm
Plating min - Mating	1.016µm
Plating min - Termination	1.016µm
Polarized to PCB	No
Stackable	No
Surface Mount Compatible (SMC)	No
Temperature Range - Operating	-20° to +80°C
Wire/Cable Type	FFC/FPC

Electrical

Current - Maximum per Contact	1.0A
Voltage - Maximum	200V

Material Info

Engineering Number 5597-17APB7F

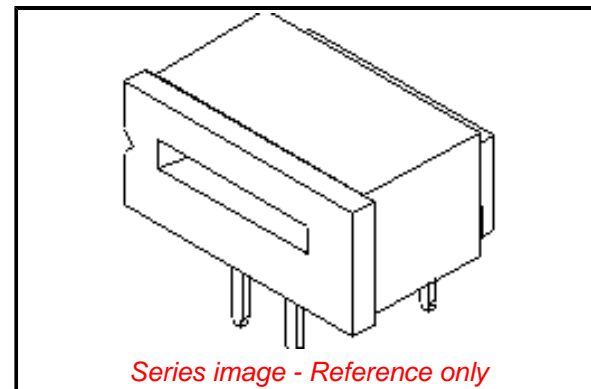

EU ELV

Not Relevant

EU RoHS

Compliant

REACH SVHC

Not Contained Per -
D(2021)4569-DC (8
July 2021)

Halogen-Free

Status

Not Low-Halogen

For more information, please visit [Contact US](#)

China ROHS

ELV

RoHS Phthalates

China RoHS

Green Image

Not Relevant

Not Contained

Search Parts in this Series

[5597 Series](#)

Reference - Drawing Numbers

Packaging Specification

Product Specification

Sales Drawing

SPK-5597-003-001

PS-5597-004-001

SD-5597-011-001

This document was generated on 01/25/2022

PLEASE CHECK WWW.MOLEX.COM FOR LATEST PART INFORMATION

X-ON Electronics

Largest Supplier of Electrical and Electronic Components

Click to view similar products for [FFC & FPC Connectors](#) category:

Click to view products by [Molex](#) manufacturer:

Other Similar products are found below :

[FPH-1422G](#) [FPH-1602G](#) [K-FC20](#) [FH29B-80S-0.2SHW\(99\)](#) [FPH-2022G](#) [AYF332735](#) [52610-1075](#) [52610-1275](#) [52610-1934](#) [501864-3091-TR225](#) [086222026001800](#) [52610-0675](#) [62684-36210E9ALF](#) [52746-1671-TR250](#) [10051922-2810EHLF](#) [6-520415-9](#) [SFV6R-1STE9HLF](#) [XF3M-2915-1B-R100](#) [1658549-1](#) [AYF534065TA](#) [AYF351525](#) [086212040340800+](#) [AYF530365TA](#) [67000-014LF](#) [67000-004LF](#) [006207341915000+](#) [DS1020-19RT1D](#) [67000-003LF](#) [67000-011LF](#) [67000-016LF](#) [HFW14R-2STE9LF](#) [SFV32R-2STBE9HLF](#) [SFW12R-5STE9LF](#) [SFW18R-1STAE9LF](#) [SFW4R-5STE9LF](#) [52807-0430](#) [046283021002868+](#) [THD1015-8CL-SN](#) [67000-006LF](#) [502250-8027](#) [104267-9617](#) [66987-011LF](#) [AYF362535](#) [F0501-T-50-20T-R](#) [F1003-ZV-12-25T-R](#) [HFW8S-2STAE1HLF](#) [67000-008LF](#) [67000-012LF](#) [ECC576069EU](#) [F1002-B-20-20T-R](#)