

**PLEASE CHECK WWW.MOLEX.COM FOR LATEST PART INFORMATION**

**Part Number:** [0397730003](#)  
**Status:** **Active**  
**Overview:** Eurostyle Terminal Blocks  
**Description:** 2.54mm Pitch Beau Eurostyle Fixed Mount PCB Terminal Block, Green, 3 Circuits

**Documents:**

<a href="#">3D Model</a>	<a href="#">Drawing (PDF)</a>
<a href="#">3D Model (PDF)</a>	<a href="#">RoHS Certificate of Compliance (PDF)</a>

**General**

Product Family	Terminal Blocks
Series	<a href="#">39773</a>
Application	N/A
Component Type	One Piece
Overview	<a href="#">Eurostyle Terminal Blocks</a>
Product Name	Eurostyle Fixed Mount
Type	Euro Block
UPC	78172560834

**Physical**

Circuits (Loaded)	3
Circuits (maximum)	3
Color - Resin	Green
Entry Angle	Horizontal
Lock to Mating Part	None
Material - Metal	Copper Alloy
Material - Plating Mating	Tin
Material - Resin	Nylon
Number of Rows	1
Orientation	Vertical
PC Tail Length	3.40mm
PCB Retention	None
PCB Thickness - Recommended	2.40mm
Panel Mount	No
Pitch - Mating Interface	2.54mm
Pitch - Termination Interface	2.54mm
Polarized to Mating Part	N/A
Shrouded	Fully
Stackable	Yes
Surface Mount Compatible (SMC)	No
Temperature Range - Operating	-40° to +110°C
Wire Size AWG	16, 18, 20, 22, 24, 26, 28, 30
Wire Size mm <sup>2</sup>	0.05-1.31

**Electrical**

Current - Maximum per Contact	10.0A
Voltage - Maximum	150V

**Material Info**

Engineering Number	MX-MSD03004
--------------------	-------------

**Reference - Drawing Numbers**

Sales Drawing	SD-39773-001-001
---------------	------------------

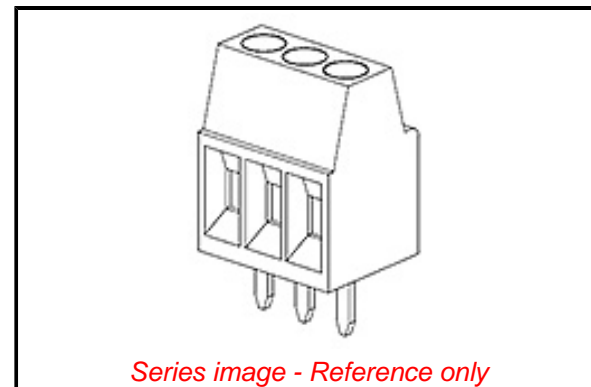

*Series image - Reference only*

**EU ELV**

**Not Relevant**

**EU RoHS**

**Compliant with Exemption 6(c)**

**REACH SVHC**

Contained Per -  
D(2021)4569-DC (8  
July 2021)

Lead

**Halogen-Free**

**Status**

**Low-Halogen**

For more information, please visit [Contact US](#)

China ROHS

50 Image

ELV

Not Relevant

RoHS Phthalates

Not Contained

**Search Parts in this Series**

[39773 Series](#)

## X-ON Electronics

Largest Supplier of Electrical and Electronic Components

*Click to view similar products for [Fixed Terminal Blocks](#) category:*

*Click to view products by [Molex](#) manufacturer:*

Other Similar products are found below :

[MBE-1512](#) [MBE-154](#) [MBE-156](#) [MBES-153](#) [MBES-156](#) [MH-2512](#) [MHE-132](#) [MHE-163](#) [MI-254 \(35\)](#) [MI-272](#) [880507](#) [MPT-275](#)  
[15602-04-08-21](#) [BA311TU](#) [BA411SU](#) [MV-152](#) [MV-252-D](#) [MV-253/NCNOC](#) [MV-254-D](#) [MV-255](#) [MV-462](#) [MV-493](#) [MVE-252](#) [MVE-253](#)  
[MVE-273](#) [MVEB-153](#) [1700096](#) [1705142](#) [1712417](#) [1713020](#) [1713088](#) [1745195](#) [1760594](#) [1776118-2](#) [1790852](#) [1-796689-8](#) [1-796692-6](#)  
[1800001](#) [1995279](#) [20020314-C121B01LF](#) [CB2-12](#) [KP03215000J0G](#) [KP04215000J0G](#) [S451](#) [282802-2](#) [29.007](#) [29.116](#) [30.103](#) [30.106](#)  
[30.252](#)