

PLEASE CHECK WWW.MOLEX.COM FOR LATEST PART INFORMATION

Part Number: [0440672201](#)
Status: **Active**
Overview: Micro-Fit Connector System
Description: Micro-Fit 3.0 Wire-to-Board Header, Dual Row, Vertical for up to 3.56mm Thick PCB, 22 Circuits, Tin (Sn) Plating

Documents:

3D Model	Test Summary 430450005-TS-000 (PDF)
Drawing (PDF)	Test Summary TS-43045-001-001 (PDF)
3D Model (PDF)	Test Summary TS-43045-002-001 (PDF)
Product Specification 430450001-PS-KO-000 (PDF)	Test Summary TS-46235-001-001 (PDF)
Product Specification 430450001-PS-SP-000 (PDF)	Symbol Footprint Data SYM-44067-220X-001 (PDF)
Product Specification PS-43045-001 (PDF)	RoHS Certificate of Compliance (PDF)
Packaging Specification PK-70873-0314-001 (PDF)	

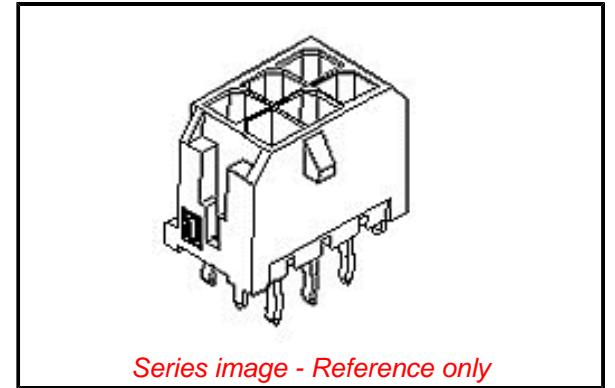

General

Product Family	PCB Headers
Series	44067
Application	Power, Wire-to-Board
Comments	High Temperature, Polarization Key to PCB
Overview	<u>Micro-Fit Connector System</u>
Product Name	Micro-Fit 3.0
UPC	800756476414

Physical

Breakaway	No
Circuits (Loaded)	22
Circuits (maximum)	22
Color - Resin	Black
Durability (mating cycles max)	30
First Mate / Last Break	No
Glow-Wire Capable	No
Guide to Mating Part	No
Keying to Mating Part	None
Lock to Mating Part	Yes
Material - Plating Mating	Tin
Material - Plating Termination	Tin
Material - Resin	High Temperature Thermoplastic
Net Weight	2.983/g
Number of Rows	2
Orientation	Vertical
PC Tail Length	4.01mm
PCB Locator	Yes
PCB Retention	Yes
PCB Thickness - Recommended	3.60mm
Packaging Type	Tray
Pitch - Mating Interface	3.00mm
Pitch - Termination Interface	3.00mm
Plating min - Mating	2.540µm
Plating min - Termination	2.540µm
Polarized to PCB	Yes
Shrouded	Fully
Stackable	No
Surface Mount Compatible (SMC)	Yes
Temperature Range - Operating	-40° to +105°C
Termination Interface: Style	Through Hole - Kinked Pin

EU ELV

Not Relevant

EU RoHS

Compliant

REACH SVHC

Not Contained Per -
D(2021)4569-DC (8
July 2021)

Halogen-Free

Status

Low-Halogen

For more information, please visit [Contact US](#)

China ROHS

ELV

RoHS Phthalates

China RoHS

Green Image

Not Relevant

Not Contained

Search Parts in this Series

[44067](#) Series

Mates With

[43025](#) Micro-Fit 3.0 Receptacle Housing

Electrical

Current - Maximum per Contact 8.5A
Voltage - Maximum 250V

Solder Process Data

Duration at Max. Process Temperature (seconds) 030
Lead-free Process Capability SMC&WAVE
Max. Cycles at Max. Process Temperature 003
Process Temperature max. C 260

Material Info**Reference - Drawing Numbers**

Packaging Specification PK-70873-0314-001
Product Specification 430450001-PS-KO-000, 430450001-PS-SP-000,
PS-43045-001
Sales Drawing SD-44067-001-001
Symbol/Footprint Data SYM-44067-220X-001
Test Summary 430450005-TS-000, TS-43045-001-001,
TS-43045-002-001, TS-46235-001-001

This document was generated on 12/27/2021

PLEASE CHECK WWW.MOLEX.COM FOR LATEST PART INFORMATION

X-ON Electronics

Largest Supplier of Electrical and Electronic Components

Click to view similar products for [Headers & Wire Housings](#) category:

Click to view products by [Molex](#) manufacturer:

Other Similar products are found below :

[892-18-020-10-001101](#) [58102-G61-06LF](#) [582553-1](#) [0009485154](#) [009176003701906](#) [0050291907](#) [LY20-4P-DT1-P1E-BR](#) [02.125.8002.8](#)
[609-3404](#) [61062-3](#) [622-0430](#) [622-3653LF](#) [63453-116](#) [636-1030](#) [636-1427](#) [636-3427](#) [636-4007](#) [641938-9](#) [641991-4](#) [644827-2](#) [65817-010LF](#)
[65817-015LF](#) [65863-015LF](#) [66207-023LF](#) [67095-007LF](#) [67601157](#) [68648-049](#) [70.362.1628.0](#) [70-4210](#) [70-4226B](#) [70-4853B](#) [707-5020](#) [707-5028](#) [71.350.2428.0](#) [71918-208LF](#) [71961-016LF](#) [733-134](#) [733-162](#) [754199-000](#) [760-3052](#) [787-8014-00](#) [79531-3000](#) [FCN-360C032-B](#) [FCN-367T-T012/H](#) [FCN-723D010/2](#) [80.063.4001.1](#) [800-90-001-10-001000](#) [800-90-010-10-002000](#) [801-43-002-10-013000](#) [801-43-006-10-002000](#)