

RECOMMENDED HOLE LAYOUT FOR .070/(1.78) MAX. THICK P.C. BOARD

VIEWED FROM COMPONENT SIDE

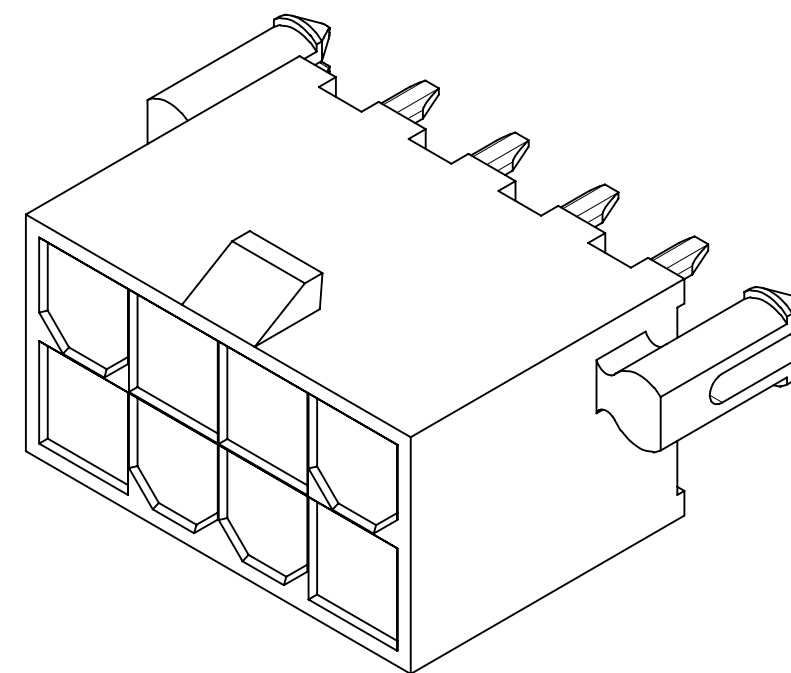

8 CKT SHOWN

CIRCUIT SIZE	DIM. "A"	DIM. "B"	DIM. "C"
2	—	.21 (5.4)	.370 (9.40)
4	.17 (4.2)	.38 (9.6)	.535 (13.60)
6	.33 (8.4)	.54 (13.8)	.701 (17.80)
8	.50 (12.6)	.71 (18.0)	.866 (22.00)
10	.66 (16.8)	.87 (22.2)	1.031 (26.20)
12	.83 (21.0)	1.04 (26.4)	1.197 (30.40)
14	.99 (25.2)	1.20 (30.6)	1.362 (34.60)
16	1.16 (29.4)	1.37 (34.8)	1.528 (38.80)
18	1.32 (33.6)	1.54 (39.0)	1.693 (43.00)
20	1.49 (37.8)	1.70 (43.2)	1.858 (47.20)
22	1.65 (42.0)	1.87 (47.4)	2.024 (51.40)
24	1.82 (46.2)	2.03 (51.6)	2.189 (55.60)

NOTES:

- HOUSING MATERIAL:
 - "BLANK" - NYLON, UNFILLED U.L. 94V-2, COLOR: NATURAL.
 - 210 - NYLON, UNFILLED U.L. 94V-0, COLOR: NATURAL.
 - BL - NYLON, UNFILLED U.L. 94V-2, COLOR: BLACK.
 - 400 - NYLON, UNFILLED U.L. 94V-0, COLOR: BLACK.
- TERMINAL MATERIAL: BRASS
- TERMINAL PLATING:
 - "BLANK" - .000035/(.00090) MIN. REFLOWED MATTE TIN OVER .000020/(.00050) MIN. COPPER. (PREPLATE) (FINISH IS BRIGHT IN APPEARANCE, THICKNESS AS APPLIED PRIOR TO REFLOW)
 - GS - .000030/(.00076) MIN. SELECT GOLD .000100/(.00254) MIN. SELECT MATTE TIN OVER .000050/(.00127) MIN. NICKEL OVERALL.
 - GS2 - .000015/(.00038) MIN. SELECT GOLD AND .000100/(.00254) MIN. SELECT MATTE TIN OVER .000050/(.00127) MIN. NICKEL OVERALL.
 - S - .000100/(.00254) MIN. BRIGHT TIN OVER .000050/(.00127) MIN. NICKEL OVERALL.
 - MS - .000100/(.00254) MIN. MATTE TIN OVER .000050/(.00127) MIN. NICKEL OVERALL.
- PRODUCT SPECIFICATION: PS-5556-001
- PACKAGING: SEE CHARTS
- PART MATES WITH MINI-FIT JR. RECEPTACLE #5557.
- MOUNTING OPTIONS:
 - "BLANK" - NO MOUNTING (SEE SD-5566-002 DWG.)
 - 2 - PEG MOUNT
- PART CONFORMS TO CLASS "B" REQUIREMENTS OF COSMETIC SPECIFICATION PS-45499-002
- ANTI-SHINGLING RIB MAY OR MAY NOT APPEAR ON HOUSINGS.
- CONNECTORS ARE NOT TO BE MATED OR UNMATED WHILE CIRCUITS ARE LIVE.
- PARTS ARE NOT DESIGNED FOR CURRENT SHARING.

LEGEND:

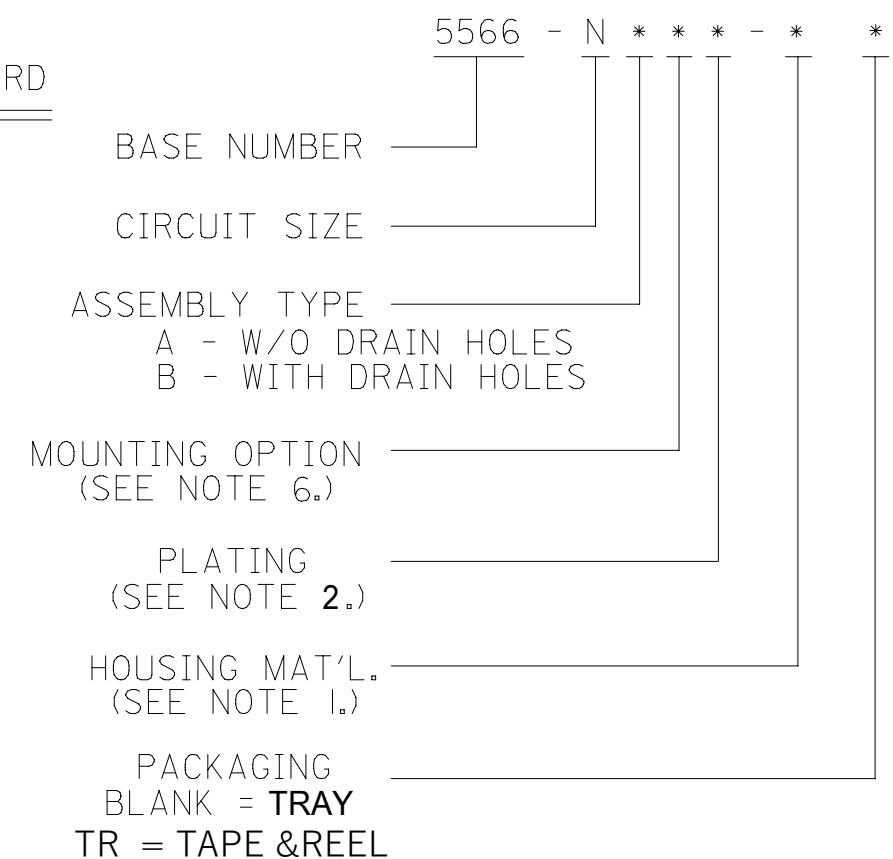

SYMBOLS		THIS DRAWING CONTAINS INFORMATION THAT IS PROPRIETARY TO MOLEX ELECTRONIC TECHNOLOGIES, LLC AND SHOULD NOT BE USED WITHOUT WRITTEN PERMISSION	
DIMENSION UNITS	SCALE	CURRENT REV DESC:	
IN/MM	4:1		
GENERAL TOLERANCES (UNLESS SPECIFIED)			
	MM	INCH	
4 PLACES	±	±	
3 PLACES	±	± 0.015	
2 PLACES	±	0.38 ± 0.02	
1 PLACE	±	0.5 ±	
0 PLACES	±	±	
ANGULAR TOL	± 0.5 °		
DRAFT WHERE APPLICABLE MUST REMAIN WITHIN DIMENSIONS			
THIRD ANGLE PROJECTION			
DRAWING		SERIES	
C-SIZE		5566	
EC NO: 650997		2020/10/23	
DRWN: HPAN18		2020/12/14	
CHK'D: YXZHENG		2020/12/14	
APPR: YXZHENG		2020/12/14	
INITIAL REVISION:			
DRWN: RJF		1987/08/19	
APPR: FSMITH		2012/01/10	
DOCUMENT NUMBER		DOC TYPE DOC PART REVISION	
55660021-SD		PSD 000 A1	
MATERIAL NUMBER		CUSTOMER	
SEE TABLE		GENERAL MARKET	
SHEET NUMBER		1 OF 4	

THIS DRAWING REPLACES SDA-5566-N*2*-*

DOCUMENT STATUS	P1	RELEASE DATE	2020/12/14	16:13:38
-----------------	----	--------------	------------	----------

12				11				10				9				8				7				6				5				4				3				2				1			
PLATING:				35 M.I. TIN				PLATING:				35 M.I. TIN				PLATING:				30 M.I. GOLD				PLATING:				30 M.I. GOLD																			
DRAIN HOLES:				WITHOUT DRAIN HOLES				DRAIN HOLES:				WITHOUT DRAIN HOLES				DRAIN HOLES:				WITHOUT DRAIN HOLES				DRAIN HOLES:				WITHOUT DRAIN HOLES																			
MTG. OPTION:				WITH PEGS				MTG. OPTION:				WITH PEGS				MTG. OPTION:				WITH PEGS				MTG. OPTION:				WITH PEGS																			
HOUSING MAT'L:				NYLON 6/6 94V-2 NATURAL				HOUSING MAT'L:				NYLON 6/6 94V-0 NATURAL				HOUSING MAT'L:				NYLON 6/6 94V-2 NATURAL				HOUSING MAT'L:				NYLON 6/6 94V-0 NATURAL																			
PACKAGING:				PK-5566-001				PACKAGING:				PK-5566-001				PACKAGING:				PK-5566-001				PACKAGING:				PK-5566-001																			
PART NO.	ENG NO.	CKTS		PART NO.	ENG NO.	CKTS		PART NO.	ENG NO.	CKTS		PART NO.	ENG NO.	CKTS		PART NO.	ENG NO.	CKTS		PART NO.	ENG NO.	CKTS																									
39-29-9023	5566 -02A2	2		39-29-9027	5566 -02A2-210	2		39-29-9025	5566 -02A2GS	2		39-29-9029	5566 -02A2GS-210	2		39-29-9029	5566 -02A2GS-210	2		39-29-9029	5566 -02A2GS-210	2																									
39-29-9043	5566 -04A2	4		39-29-9047	5566 -04A2-210	4		39-29-9045	5566 -04A2GS	4		39-29-9049	5566 -04A2GS-210	4		39-29-9049	5566 -04A2GS-210	4		39-29-9049	5566 -04A2GS-210	4																									
39-29-9063	5566 -06A2	6		39-29-9067	5566 -06A2-210	6		39-29-9065	5566 -06A2GS	6		39-29-9069	5566 -06A2GS-210	6		39-29-9069	5566 -06A2GS-210	6		39-29-9069	5566 -06A2GS-210	6																									
39-29-9083	5566 -08A2	8		39-29-9087	5566 -08A2-210	8		39-29-9085	5566 -08A2GS	8		39-29-9089	5566 -08A2GS-210	8		39-29-9089	5566 -08A2GS-210	8		39-29-9089	5566 -08A2GS-210	8																									
39-29-9103	5566 -10A2	10		39-29-9107	5566 -10A2-210	10		39-29-9105	5566 -10A2GS	10		39-29-9109	5566 -10A2GS-210	10		39-29-9109	5566 -10A2GS-210	10		39-29-9109	5566 -10A2GS-210	10																									
39-29-9123	5566 -12A2	12		39-29-9127	5566 -12A2-210	12		39-29-9125	5566 -12A2GS	12		39-29-9129	5566 -12A2GS-210	12		39-29-9129	5566 -12A2GS-210	12		39-29-9129	5566 -12A2GS-210	12																									
39-29-9143	5566 -14A2	14		39-29-9147	5566 -14A2-210	14		39-29-9145	5566 -14A2GS	14		39-29-9149	5566 -14A2GS-210	14		39-29-9149	5566 -14A2GS-210	14		39-29-9149	5566 -14A2GS-210	14																									
39-29-9163	5566 -16A2	16		39-29-9167	5566 -16A2-210	16		39-29-9165	5566 -16A2GS	16		39-29-9169	5566 -16A2GS-210	16		39-29-9169	5566 -16A2GS-210	16		39-29-9169	5566 -16A2GS-210	16																									
39-29-9183	5566 -18A2	18		39-29-9187	5566 -18A2-210	18		39-29-9185	5566 -18A2GS	18		39-29-9189	5566 -18A2GS-210	18		39-29-9189	5566 -18A2GS-210	18		39-29-9189	5566 -18A2GS-210	18																									
39-29-9203	5566 -20A2	20		39-29-9207	5566 -20A2-210	20		39-29-9205	5566 -20A2GS	20		39-29-9209	5566 -20A2GS-210	20		39-29-9209	5566 -20A2GS-210	20		39-29-9209	5566 -20A2GS-210	20																									
39-29-9223	5566 -22A2	22		39-29-9227	5566 -22A2-210	22		39-29-9225	5566 -22A2GS	22		39-29-9229	5566 -22A2GS-210	22		39-29-9229	5566 -22A2GS-210	22		39-29-9229	5566 -22A2GS-210	22																									
39-29-9243	5566 -24A2	24		39-29-9247	5566 -24A2-210	24		39-29-9245	5566 -24A2GS	24		39-29-9249	5566 -24A2GS-210	24		39-29-9249	5566 -24A2GS-210	24		39-29-9249	5566 -24A2GS-210	24																									
	-				-				-				-				-				-																										
	-				-				-				-				-				-																										









PLATING:				35 M.I. TIN				PLATING:				35 M.I. TIN				PLATING:				30 M.I. GOLD				PLATING:				30 M.I. GOLD			
DRAIN HOLES:				WITH DRAIN HOLES				DRAIN HOLES:				WITH DRAIN HOLES				DRAIN HOLES:				WITH DRAIN HOLES				DRAIN HOLES:				WITH DRAIN HOLES			
MTG. OPTION:				WITH PEGS				MTG. OPTION:				WITH PEGS				MTG. OPTION:				WITH PEGS				MTG. OPTION:				WITH PEGS			
HOUSING MAT'L:				NYLON 6/6 94V-2 NATURAL				HOUSING MAT'L:				NYLON 6/6 94V-0 NATURAL				HOUSING MAT'L:				NYLON 6/6 94V-2 NATURAL				HOUSING MAT'L:				NYLON 6/6 94V-0 NATURAL			
PACKAGING:				PK-5566-001				PACKAGING:				PK-5566-001				PACKAGING:				PK-5566-001				PACKAGING:				PK-5566-001			
PART NO.	ENG NO.	CKTS		PART NO.	ENG NO.	CKTS		PART NO.	ENG NO.	CKTS		PART NO.	ENG NO.	CKTS		PART NO.	ENG NO.	CKTS		PART NO.	ENG NO.	CKTS									
	5566 -02B2	2			5566 -02B2-210	2			5566 -02B2GS	2			5566 -02B2GS-210	2			5566 -02B2GS-210	2			5566 -02B2GS-210	2									
39-29-9042	5566 -04B2	4		39-29-9046	5566 -04B2-210	4		39-29-9044	5566 -04B2GS	4		39-28-9048	5566 -04B2GS-210	4		39-28-9048	5566 -04B2GS-210	4		39-28-9048	5566 -04B2GS-210	4									
39-29-9062	5566 -06B2	6		39-29-9066	5566 -06B2-210	6		39-29-9064	5566 -06B2GS	6		39-28-9068	5566 -06B2GS-210	6		39-28-9068	5566 -06B2GS-210	6		39-28-9068	5566 -06B2GS-210	6									
39-29-9082	5566 -08B2	8		39-29-9086	5566 -08B2-210	8		39-29-9084	5566 -08B2GS	8		39-28-9088	5566 -08B2GS-210	8		39-28-9088	5566 -08B2GS-210	8		39-28-9088	5566 -08B2GS-210	8									
39-29-9102	5566 -10B2	10		39-29-9106	5566 -10B2-210	10		39-29-9104	5566 -10B2GS	10		39-28-9108	5566 -10B2GS-210	10		39-28-9108	5566 -10B2GS-210	10		39-28-9108	5566 -10B2GS-210	10									
39-29-9122	5566 -12B2	12		39-29-9126	5566 -12B2-210	12		39-29-9124	5566 -12B2GS	12		39-28-9128	5566 -12B2GS-210	12		39-28-9128	5566 -12B2GS-210	12		39-28-9128	5566 -12B2GS-210	12									
39-29-9142	5566 -14B2	14		39-29-9146	5566 -14B2-210	14		39-29-9144	5566 -14B2GS	14		39-28-9148	5566 -14B2GS-210	14		39-28-9148	5566 -14B2GS-210	14		39-28-9148	5566 -14B2GS-210	14									
39-29-9162	5566 -16B2	16		39-29-9166	5566 -16B2-210	16		39-29-9164	5566 -16B2GS	16		39-28-9168	5566 -16B2GS-210	16		39-28-9168	5566 -16B2GS-210	16		39-28-9168	5566 -16B2GS-210	16									
39-29-9182	5566 -18B2	18		39-29-9186	5566 -18B2-210	18		39-29-9184	5566 -18B2GS	18		39-28-9188	5566 -18B2GS-210	18		39-28-9188	5566 -18B2GS-210	18		39-28-9188	5566 -18B2GS-210	18									
39-29-9202	5566 -20B2	20		39-29-9206	5566 -20B2-210	20		39-29-9204	5566 -20B2GS	20		39-28-9208	5566 -20B2GS-210	20		39-28-9208	5566 -20B2GS-210	20		39-28-9208	5566 -20B2GS-210	20									
39-29-9222	5566 -22B2	22			5566 -22B2-210	22		39-29-9224	5566 -22B2GS	22			5566 -22B2GS-210	22			5566 -22B2GS-210	22			5566 -22B2GS-210	22									
39-29-9242	5566 -24B2	24		39-29-9246	5566 -24B2-210	24		39-29-9244	5566 -24B2GS	24		39-28-9248	5566 -24B2GS-210	24		39-28-9248	5566 -24B2GS-210	24		39-28-9248	5566 -24B2GS-210	24									
	-				-				-				-				-				-										
	-				-				-				-				-				-										

C																																																																																																																																																																																																																																																																																																													
B																																																																																																																																																																																																																																																																																																													
A																																																																																																																																																																																																																																																																																																													
<table border="1"> <thead> <tr> <th colspan="2">SYMBOLS</th> <th colspan="12">THIS DRAWING CONTAINS INFORMATION THAT IS PROPRIETARY TO MOLEX ELECTRONIC TECHNOLOGIES, LLC AND SHOULD NOT BE USED WITHOUT WRITTEN PERMISSION</th> </tr> <tr> <th colspan="2"></th> <th colspan="4">DIMENSION UNITS</th> <th colspan="4">SCALE</th> <th colspan="4">CURRENT REV DESC:</th> </tr> </thead> <tbody> <tr> <td>▽ = 0</td> <td></td> <td colspan="4">IN/MM</td> <td colspan="4">1:1</td> <td colspan="4" rowspan="3"> EC NO: 650997 DRWN: HPAN18 2020/10/23 CHK'D: YXZHENG 2020/12/14 APPR: YXZHENG 2020/12/14 INITIAL REVISION: DRWN: RJF 1987/08/19 APPR: FSMITH 2012/01/10 </td> </tr> <tr> <td>▽ = 0</td> <td></td> <td colspan="8">GENERAL TOLERANCES (UNLESS SPECIFIED)</td> </tr> <tr> <td>▽ = 0</td> <td></td> <td>MM</td> <td>INCH</td> <td></td> <td></td> <td></td> <td></td> <td></td> <td></td> </tr> <tr> <td>▽ = 0</td> <td></td> <td>4 PLACES</td> <td>±</td> <td></td> <td>±</td> <td></td> <td></td> <td></td> <td></td> <td></td> <td></td> <td></td> <td></td> <td></td> <td></td> <td></td> <td></td> <td></td> <td></td> <td></td> <td></td> <td></td> </tr> <tr> <td>▽ = 0</td> <td></td> <td>3 PLACES</td> <td>±</td> <td></td> <td>±</td> <td>0.015</td> <td></td> <td></td> <td></td> <td></td> <td></td> <td></td> <td></td> <td></td> <td></td> <td></td> <td></td> <td></td> <td></td> <td></td> <td></td> <td></td> </tr> <tr> <td>▽ = 0</td> <td></td> <td>2 PLACES</td> <td>±</td> <td>0.38</td> <td>±</td> <td>0.02</td> <td></td> <td></td> <td></td> <td></td> <td></td> <td></td> <td></td> <td></td> <td></td> <td></td> <td></td> <td></td> <td></td> <td></td> <td></td> <td></td> </tr> <tr> <td>▽ = 0</td> <td></td> <td>1 PLACE</td> <td>±</td> <td>0.5</td> <td>±</td> <td></td> <td></td> <td></td> <td></td> <td></td> <td></td> <td></td> <td></td> <td></td> <td></td> <td></td> <td></td> <td></td> <td></td> <td></td> <td></td> <td></td> </tr> <tr> <td>▽ = 0</td> <td></td> <td>0 PLACES</td> <td>±</td> <td></td> <td>±</td> <td></td> <td></td> <td></td> <td></td> <td></td> <td></td> <td></td> <td></td> <td></td> <td></td> <td></td> <td></td> <td></td> <td></td> <td></td> <td></td> <td></td> </tr> <tr> <td>▽ = 0</td> <td></td> <td colspan="4">ANGULAR TOL ± 0.5 °</td> <td colspan="4">THIRD ANGLE PROJECTION</td> <td colspan="4">DRAWING SERIES</td> </tr> <tr> <td>▽ = 0</td> <td></td> <td colspan="4">DRAFT WHERE APPLICABLE MUST REMAIN WITHIN DIMENSIONS</td> <td colspan="4">C-SIZE</td> <td colspan="4">5566</td> </tr> </tbody> </table>																								SYMBOLS		THIS DRAWING CONTAINS INFORMATION THAT IS PROPRIETARY TO MOLEX ELECTRONIC TECHNOLOGIES, LLC AND SHOULD NOT BE USED WITHOUT WRITTEN PERMISSION														DIMENSION UNITS				SCALE				CURRENT REV DESC:				▽ = 0		IN/MM				1:1				EC NO: 650997 DRWN: HPAN18 2020/10/23 CHK'D: YXZHENG 2020/12/14 APPR: YXZHENG 2020/12/14 INITIAL REVISION: DRWN: RJF 1987/08/19 APPR: FSMITH 2012/01/10				▽ = 0		GENERAL TOLERANCES (UNLESS SPECIFIED)								▽ = 0		MM	INCH							▽ = 0		4 PLACES	±		±																		▽ = 0		3 PLACES	±		±	0.015																	▽ = 0		2 PLACES	±	0.38	±	0.02																	▽ = 0		1 PLACE	±	0.5	±																		▽ = 0		0 PLACES	±		±																		▽ = 0		ANGULAR TOL ± 0.5 °				THIRD ANGLE PROJECTION				DRAWING SERIES				▽ = 0		DRAFT WHERE APPLICABLE MUST REMAIN WITHIN DIMENSIONS				C-SIZE				5566																																																																												
SYMBOLS		THIS DRAWING CONTAINS INFORMATION THAT IS PROPRIETARY TO MOLEX ELECTRONIC TECHNOLOGIES, LLC AND SHOULD NOT BE USED WITHOUT WRITTEN PERMISSION																																																																																																																																																																																																																																																																																																											
		DIMENSION UNITS				SCALE				CURRENT REV DESC:																																																																																																																																																																																																																																																																																																			
▽ = 0		IN/MM				1:1				EC NO: 650997 DRWN: HPAN18 2020/10/23 CHK'D: YXZHENG 2020/12/14 APPR: YXZHENG 2020/12/14 INITIAL REVISION: DRWN: RJF 1987/08/19 APPR: FSMITH 2012/01/10																																																																																																																																																																																																																																																																																																			
▽ = 0		GENERAL TOLERANCES (UNLESS SPECIFIED)																																																																																																																																																																																																																																																																																																											
▽ = 0		MM	INCH																																																																																																																																																																																																																																																																																																										
▽ = 0		4 PLACES	±		±																																																																																																																																																																																																																																																																																																								
▽ = 0		3 PLACES	±		±	0.015																																																																																																																																																																																																																																																																																																							
▽ = 0		2 PLACES	±	0.38	±	0.02																																																																																																																																																																																																																																																																																																							
▽ = 0		1 PLACE	±	0.5	±																																																																																																																																																																																																																																																																																																								
▽ = 0		0 PLACES	±		±																																																																																																																																																																																																																																																																																																								
▽ = 0		ANGULAR TOL ± 0.5 °				THIRD ANGLE PROJECTION				DRAWING SERIES																																																																																																																																																																																																																																																																																																			
▽ = 0		DRAFT WHERE APPLICABLE MUST REMAIN WITHIN DIMENSIONS				C-SIZE				5566																																																																																																																																																																																																																																																																																																			
<table border="1"> <thead> <tr> <th colspan="2">DOCUMENT STATUS</th> <th colspan="2">P1</th> <th colspan="2">RELEASE DATE</th> <th colspan="2">2020/12/14 16:13:38</th> </tr> </thead> <tbody> <tr> <td colspan="2">molex</td> <td colspan="2">MINIFIT JR VERT HDR ASSY'S W/ PEGS</td> <td colspan="2">PRODUCT CUSTOMER DRAWING</td> <td colspan="2">DOCUMENT NUMBER</td> <td colspan="2">DOC TYPE</td> <td colspan="2">DOC PART</td> <td colspan="2">REVISION</td> </tr> <tr> <td colspan="2">55660021-SD</td> <td colspan="2">PSD</td> <td colspan="2">000</td> <td colspan="2">A1</td> <td colspan="2">MATERIAL NUMBER</td> <td colspan="2">CUSTOMER</td> <td colspan="2">SHEET NUMBER</td> </tr> <tr> <td colspan="2">SEE TABLE</td> <td colspan="2">GENERAL MARKET</td> <td colspan="2">2 OF 4</td> <td colspan="2"></td> <td colspan="2"></td> <td colspan="2"></td> <td colspan="2"></td> </tr> </tbody> </table>																								DOCUMENT STATUS		P1		RELEASE DATE		2020/12/14 16:13:38		molex		MINIFIT JR VERT HDR ASSY'S W/ PEGS		PRODUCT CUSTOMER DRAWING		DOCUMENT NUMBER		DOC TYPE		DOC PART		REVISION		55660021-SD		PSD		000		A1		MATERIAL NUMBER		CUSTOMER		SHEET NUMBER		SEE TABLE		GENERAL MARKET		2 OF 4																																																																																																																																																																																																																																													
DOCUMENT STATUS		P1		RELEASE DATE		2020/12/14 16:13:38																																																																																																																																																																																																																																																																																																							
molex		MINIFIT JR VERT HDR ASSY'S W/ PEGS		PRODUCT CUSTOMER DRAWING		DOCUMENT NUMBER		DOC TYPE		DOC PART		REVISION																																																																																																																																																																																																																																																																																																	
55660021-SD		PSD		000		A1		MATERIAL NUMBER		CUSTOMER		SHEET NUMBER																																																																																																																																																																																																																																																																																																	
SEE TABLE		GENERAL MARKET		2 OF 4																																																																																																																																																																																																																																																																																																									
<table border="1"> <thead> <tr> <th colspan="4">12</th> <th colspan="4">11</th> <th colspan="4">10</th> <th colspan="4">9</th> <th colspan="4">8</th> <th colspan="4">7</th> <th colspan="4">6</th> <th colspan="4">5</th> <th colspan="4">4</th> <th colspan="4">3</th> <th colspan="4">2</th> <th colspan="4">1</th> </tr> </thead> <tbody> <tr> <td colspan="4">PLATING:</td> <td colspan="4">35 M.I. TIN</td> <td colspan="4">PLATING:</td> <td colspan="4">35 M.I. TIN</td> <td colspan="4">PLATING:</td> <td colspan="4">30 M.I. GOLD</td> <td colspan="4">PLATING:</td> <td colspan="4">30 M.I. GOLD</td> </tr> <tr> <td colspan="4">DRAIN HOLES:</td> <td colspan="4">WITHOUT DRAIN HOLES</td> <td colspan="4">DRAIN HOLES:</td> <td colspan="4">WITHOUT DRAIN HOLES</td> <td colspan="4">DRAIN HOLES:</td> <td colspan="4">WITHOUT DRAIN HOLES</td> <td colspan="4">DRAIN HOLES:</td> <td colspan="4">WITHOUT DRAIN HOLES</td> </tr> <tr> <td colspan="4">MTG. OPTION:</td> <td colspan="4">WITH PEGS</td> <td colspan="4">MTG. OPTION:</td> <td colspan="4">WITH PEGS</td> <td colspan="4">MTG. OPTION:</td> <td colspan="4">WITH PEGS</td> <td colspan="4">MTG. OPTION:</td> <td colspan="4">WITH PEGS</td> </tr> <tr> <td colspan="4">HOUSING MAT'L:</td> <td colspan="4">NYLON 6/6 94V-2 NATURAL</td> <td colspan="4">HOUSING MAT'L:</td> <td colspan="4">NYLON 6/6 94V-0 NATURAL</td> <td colspan="4">HOUSING MAT'L:</td> <td colspan="4">NYLON 6/6 94V-2 NATURAL</td> <td colspan="4">HOUSING MAT'L:</td> <td colspan="4">NYLON 6/6 94V-0 NATURAL</td> </tr> <tr> <td colspan="4">PACKAGING:</td> <td colspan="4">PK-5566-001</td> <td colspan="4">PACKAGING:</td> <td colspan="4">PK-5566-001</td> <td colspan="4">PACKAGING:</td> <td colspan="4">PK-5566-001</td> <td colspan="4">PACKAGING:</td> <td colspan="4">PK-5566-001</td> </tr> <tr> <td>PART NO.</td> <td>ENG NO.</td> <td>CKTS</td> <td></td> <td>PART NO.</td> <td>ENG NO.</td> <td>CKTS</td> <td></td> <td>PART NO.</td> <td>ENG NO.</td> <td>CKTS</td> <td></td> <td>PART NO.</td> <td>ENG NO.</td> <td>CKTS</td> <td></td> <td>PART NO.</td> <td>ENG NO.</td> <td>CKTS</td> <td></td> <td>PART NO.</td> <td>ENG NO.</td> <td>CKTS</td> <td></td> </tr> <tr> <td></td> <td>5566 -02B2</td> <td>2</td> <td></td> <td></td> <td>5566 -02B2-210</td> <td>2</td> <td></td> <td></td> <td>5566 -02B2GS</td> <td>2</td> <td></td> <td></td> <td>5566 -02B2GS-210</td> <td>2</td> <td></td> <td></td> <td>5566 -02B2GS-210</td> <td>2</td> <td></td> <td></td> <td>5566 -02B2GS-210</td> <td>2</td> <td></td> </tr> <tr> <td>39-29-9042</td> <td>5566 -04B2</td> <td>4</td> <td></td> <td>39-29-9046</td> <td>5566 -04B2-210</td> <td>4</td> <td></td> <td>39-29-9044</td> <td>5566 -04B2GS</td> <td>4</td> <td></td> <td>39-28-9048</td> <td>5566 -04B2GS-210</td> <td>4</td> <td></td> <td>39-28-9048</td> <td>5566 -04B2GS-210</td> <td>4</td> <td></td> <td>39-28-9048</td> <td>5566 -04B</td></tr></tbody></table>																								12				11				10				9				8				7				6				5				4				3				2				1				PLATING:				35 M.I. TIN				PLATING:				35 M.I. TIN				PLATING:				30 M.I. GOLD				PLATING:				30 M.I. GOLD				DRAIN HOLES:				WITHOUT DRAIN HOLES				DRAIN HOLES:				WITHOUT DRAIN HOLES				DRAIN HOLES:				WITHOUT DRAIN HOLES				DRAIN HOLES:				WITHOUT DRAIN HOLES				MTG. OPTION:				WITH PEGS				MTG. OPTION:				WITH PEGS				MTG. OPTION:				WITH PEGS				MTG. OPTION:				WITH PEGS				HOUSING MAT'L:				NYLON 6/6 94V-2 NATURAL				HOUSING MAT'L:				NYLON 6/6 94V-0 NATURAL				HOUSING MAT'L:				NYLON 6/6 94V-2 NATURAL				HOUSING MAT'L:				NYLON 6/6 94V-0 NATURAL				PACKAGING:				PK-5566-001				PACKAGING:				PK-5566-001				PACKAGING:				PK-5566-001				PACKAGING:				PK-5566-001				PART NO.	ENG NO.	CKTS		PART NO.	ENG NO.	CKTS		PART NO.	ENG NO.	CKTS		PART NO.	ENG NO.	CKTS		PART NO.	ENG NO.	CKTS		PART NO.	ENG NO.	CKTS			5566 -02B2	2			5566 -02B2-210	2			5566 -02B2GS	2			5566 -02B2GS-210	2			5566 -02B2GS-210	2			5566 -02B2GS-210	2		39-29-9042	5566 -04B2	4		39-29-9046	5566 -04B2-210	4		39-29-9044	5566 -04B2GS	4		39-28-9048	5566 -04B2GS-210	4		39-28-9048	5566 -04B2GS-210	4		39-28-9048	5566 -04B
12				11				10				9				8				7				6				5				4				3				2				1																																																																																																																																																																																																																																																																	
PLATING:				35 M.I. TIN				PLATING:				35 M.I. TIN				PLATING:				30 M.I. GOLD				PLATING:				30 M.I. GOLD																																																																																																																																																																																																																																																																																	
DRAIN HOLES:				WITHOUT DRAIN HOLES				DRAIN HOLES:				WITHOUT DRAIN HOLES				DRAIN HOLES:				WITHOUT DRAIN HOLES				DRAIN HOLES:				WITHOUT DRAIN HOLES																																																																																																																																																																																																																																																																																	
MTG. OPTION:				WITH PEGS				MTG. OPTION:				WITH PEGS				MTG. OPTION:				WITH PEGS				MTG. OPTION:				WITH PEGS																																																																																																																																																																																																																																																																																	
HOUSING MAT'L:				NYLON 6/6 94V-2 NATURAL				HOUSING MAT'L:				NYLON 6/6 94V-0 NATURAL				HOUSING MAT'L:				NYLON 6/6 94V-2 NATURAL				HOUSING MAT'L:				NYLON 6/6 94V-0 NATURAL																																																																																																																																																																																																																																																																																	
PACKAGING:				PK-5566-001				PACKAGING:				PK-5566-001				PACKAGING:				PK-5566-001				PACKAGING:				PK-5566-001																																																																																																																																																																																																																																																																																	
PART NO.	ENG NO.	CKTS		PART NO.	ENG NO.	CKTS		PART NO.	ENG NO.	CKTS		PART NO.	ENG NO.	CKTS		PART NO.	ENG NO.	CKTS		PART NO.	ENG NO.	CKTS																																																																																																																																																																																																																																																																																							
	5566 -02B2	2			5566 -02B2-210	2			5566 -02B2GS	2			5566 -02B2GS-210	2			5566 -02B2GS-210	2			5566 -02B2GS-210	2																																																																																																																																																																																																																																																																																							
39-29-9042	5566 -04B2	4		39-29-9046	5566 -04B2-210	4		39-29-9044	5566 -04B2GS	4		39-28-9048	5566 -04B2GS-210	4		39-28-9048	5566 -04B2GS-210	4		39-28-9048	5566 -04B																																																																																																																																																																																																																																																																																								

12				11				10				9				8				7				6				5				4				3				2				1			
PLATING:				100 M.I. BRIGHT TIN				PLATING:				100 M.I. BRIGHT TIN				PLATING:				15 M.I. SELECT GOLD				PLATING:				15 M.I. SELECT GOLD																			
DRAIN HOLES:				WITHOUT DRAIN HOLES				DRAIN HOLES:				WITHOUT DRAIN HOLES				DRAIN HOLES:				WITHOUT DRAIN HOLES				DRAIN HOLES:				WITHOUT DRAIN HOLES																			
MTG. OPTION:				WITH PEGS				MTG. OPTION:				WITH PEGS				MTG. OPTION:				WITH PEGS				MTG. OPTION:				WITH PEGS																			
HOUSING MAT'L:				NYLON 6/6 94V-2 NATURAL				HOUSING MAT'L:				NYLON 6/6 94V-0 NATURAL				HOUSING MAT'L:				NYLON 6/6 94V-2 NATURAL				HOUSING MAT'L:				NYLON 6/6 94V-0 NATURAL																			
PACKAGING:				PK-5566-001				PACKAGING:				PK-5566-001				PACKAGING:				PK-5566-001				PACKAGING:				PK-5566-001																			
PART NO.	ENG NO.	CKTS		PART NO.	ENG NO.	CKTS		PART NO.	ENG NO.	CKTS		PART NO.	ENG NO.	CKTS		PART NO.	ENG NO.	CKTS		PART NO.	ENG NO.	CKTS		PART NO.	ENG NO.	CKTS		PART NO.	ENG NO.	CKTS																	
39-30-6025	5566 -02A2S	2		39-30-6026	5566 -02A2S-210	2		39-30-0026	5566 -02A2GS2	2		39-30-0027	5566 -02A2GS2-210	2		39-30-0026	5566 -02A2GS2	2		39-30-0027	5566 -02A2GS2-210	2		39-30-0026	5566 -02A2GS2	2		39-30-0027	5566 -02A2GS2-210	2																	
39-30-6045	5566 -04A2S	4		39-30-6046	5566 -04A2S-210	4		39-30-0046	5566 -04A2GS2	4		39-30-0047	5566 -04A2GS2-210	4		39-30-0046	5566 -04A2GS2	4		39-30-0047	5566 -04A2GS2-210	4		39-30-0046	5566 -04A2GS2	4		39-30-0047	5566 -04A2GS2-210	4																	
39-30-6065	5566 -06A2S	6		39-30-6066	5566 -06A2S-210	6		39-30-0066	5566 -06A2GS2	6		39-30-0067	5566 -06A2GS2-210	6		39-30-0066	5566 -06A2GS2	6		39-30-0067	5566 -06A2GS2-210	6		39-30-0066	5566 -06A2GS2	6		39-30-0067	5566 -06A2GS2-210	6																	
39-30-6085	5566 -08A2S	8		39-30-6086	5566 -08A2S-210	8		39-30-0086	5566 -08A2GS2	8		39-30-0087	5566 -08A2GS2-210	8		39-30-0086	5566 -08A2GS2	8		39-30-0087	5566 -08A2GS2-210	8		39-30-0086	5566 -08A2GS2	8		39-30-0087	5566 -08A2GS2-210	8																	
39-30-6105	5566 -10A2S	10		39-30-6106	5566 -10A2S-210	10		39-30-0106	5566 -10A2GS2	10		39-30-0107	5566 -10A2GS2-210	10		39-30-0106	5566 -10A2GS2	10		39-30-0107	5566 -10A2GS2-210	10		39-30-0106	5566 -10A2GS2	10		39-30-0107	5566 -10A2GS2-210	10																	
39-30-6125	5566 -12A2S	12		39-30-6126	5566 -12A2S-210	12		39-30-0126	5566 -12A2GS2	12		39-30-0127	5566 -12A2GS2-210	12		39-30-0126	5566 -12A2GS2	12		39-30-0127	5566 -12A2GS2-210	12		39-30-0126	5566 -12A2GS2	12		39-30-0127	5566 -12A2GS2-210	12																	
39-30-6145	5566 -14A2S	14		39-30-6146	5566 -14A2S-210	14		39-30-0146	5566 -14A2GS2	14		39-30-0147	5566 -14A2GS2-210	14		39-30-0146	5566 -14A2GS2	14		39-30-0147	5566 -14A2GS2-210	14		39-30-0146	5566 -14A2GS2	14		39-30-0147	5566 -14A2GS2-210	14																	
39-30-6165	5566 -16A2S	16		39-30-6166	5566 -16A2S-210	16		39-30-0166	5566 -16A2GS2	16		39-30-0167	5566 -16A2GS2-210	16		39-30-0166	5566 -16A2GS2	16		39-30-0167	5566 -16A2GS2-210	16		39-30-0166	5566 -16A2GS2	16		39-30-0167	5566 -16A2GS2-210	16																	
39-30-6185	5566 -18A2S	18		39-30-6186	5566 -18A2S-210	18		39-30-0186	5566 -18A2GS2	18		39-30-0187	5566 -18A2GS2-210	18		39-30-0186	5566 -18A2GS2	18		39-30-0187	5566 -18A2GS2-210	18		39-30-0186	5566 -18A2GS2	18		39-30-0187	5566 -18A2GS2-210	18																	
39-30-6205	5566 -20A2S	20		39-30-6206	5566 -20A2S-210	20		39-30-0206	5566 -20A2GS2	20		39-30-0207	5566 -20A2GS2-210	20		39-30-0206	5566 -20A2GS2	20		39-30-0207	5566 -20A2GS2-210	20		39-30-0206	5566 -20A2GS2	20		39-30-0207	5566 -20A2GS2-210	20																	
39-30-6225	5566 -22A2S	22		39-30-6226	5566 -22A2S-210	22		39-30-0226	5566 -22A2GS2	22		39-30-0227	5566 -22A2GS2-210	22		39-30-0226	5566 -22A2GS2	22		39-30-0227	5566 -22A2GS2-210	22		39-30-0226	5566 -22A2GS2	22		39-30-0227	5566 -22A2GS2-210	22																	
39-30-6245	5566 -24A2S	24		39-30-6246	5566 -24A2S-210	24		39-30-0246	5566 -24A2GS2	24		39-30-0247	5566 -24A2GS2-210	24		39-30-0246	5566 -24A2GS2	24		39-30-0247	5566 -24A2GS2-210	24		39-30-0246	5566 -24A2GS2	24		39-30-0247	5566 -24A2GS2-210	24																	
	-				-				-				-				-				-				-					-																	

12				11				10				9				8				7				6				5				4				3				2				1			
PLATING:				100 M.I. BRIGHT TIN				PLATING:				100 M.I. BRIGHT TIN				PLATING:				100 M.I. MATTE TIN				PLATING:				100 M.I. MATTE TIN																			
DRAIN HOLES:				WITH DRAIN HOLES				DRAIN HOLES:				WITH DRAIN HOLES				DRAIN HOLES:				WITHOUT DRAIN HOLES				DRAIN HOLES:				WITHOUT DRAIN HOLES																			
MTG. OPTION:				WITH PEGS				MTG. OPTION:				WITH PEGS				MTG. OPTION:				WITH PEGS				MTG. OPTION:				WITH PEGS																			
HOUSING MAT'L:				NYLON 6/6 94V-2 NATURAL				HOUSING MAT'L:				NYLON 6/6 94V-0 NATURAL				HOUSING MAT'L:				NYLON 6/6 94V-2 NATURAL				HOUSING MAT'L:				NYLON 6/6 94V-0 NATURAL																			
PACKAGING:				PK-5566-001				PACKAGING:				PK-5566-001				PACKAGING:				PK-5566-001				PACKAGING:				PK-5566-001																			
PART NO.	ENG NO.	CKTS		PART NO.	ENG NO.	CKTS		PART NO.	ENG NO.	CKTS		PART NO.	ENG NO.	CKTS		PART NO.	ENG NO.	CKTS		PART NO.	ENG NO.	CKTS		PART NO.	ENG NO.	CKTS		PART NO.	ENG NO.	CKTS																	
	5566 -02B2S	2			5566 -02B2S-210	2		46999-0612	5566-02A2MS	2		46999-0621	5566-02A2MS-210	2		46999-0612	5566-02A2MS	2		46999-0621	5566-02A2MS-210	2		46999-0612	5566-02A2MS	2		46999-0621	5566-02A2MS-210	2																	
39-30-6047	5566 -04B2S	4		39-30-6048	5566 -04B2S-210	4		46999-0501	5566-04A2MS	4		46999-0502	5566-04A2MS-210	4		46999-0501	5566-04A2MS	4		46999-0502	5566-04A2MS-210	4		46999-0501	5566-04A2MS	4		46999-0502	5566-04A2MS-210	4																	
39-30-6067	5566 -06B2S	6		39-30-6068	5566 -06B2S-210	6		50-34-8559	5566-06A2MS	6		50-34-8562	5566-06A2MS-210	6		50-34-8559	5566-06A2MS	6		50-34-8562	5566-06A2MS-210	6		50-34-8559	5566-06A2MS	6		50-34-8562	5566-06A2MS-210	6																	
39-30-6087	5566 -08B2S	8		39-30-6088	5566 -08B2S-210	8		46999-0613	5566-08A2MS	8		50-34-8563	5566-08A2MS-210	8		46999-0613	5566-08A2MS	8		50-34-8563	5566-08A2MS-210	8		46999-0613	5566-08A2MS	8		50-34-8563	5566-08A2MS-210	8																	
39-30-6107	5566 -10B2S	10		39-30-6108	5566 -10B2S-210	10		46999-0614	5566-10A2MS	10		46999-0622	5566-10A2MS-210	10		46999-0614	5566-10A2MS	10		46999-0622	5566-10A2MS-210	10		46999-0614	5566-10A2MS	10		46999-0622	5566-10A2MS-210	10																	
39-30-6127	5566 -12B2S	12		39-30-6128	5566 -12B2S-210	12		46999-0615	5566-12A2MS	12		46999-0623	5566-12A2MS-210	12		46999-0615	5566-12A2MS	12		46999-0623	5566-12A2MS-210	12		46999-0615	5566-12A2MS	12		46999-0623	5566-12A2MS-210	12																	
39-30-6147	5566 -14B2S	14		39-30-6148	5566 -14B2S-210	14		46999-0616	5566-14A2MS	14		50-34-8561	5566-14A2MS-210	14		46999-0616	5566-14A2MS	14		50-34-8561	5566-14A2MS-210	14		46999-0616	5566-14A2MS	14		50-34-8561	5566-14A2MS-210	14																	
39-30-6167	5566 -16B2S	16		39-30-6168	5566 -16B2S-210	16		46999-0617	5566-16A2MS	16		46999-0624	5566-16A2MS-210	16		46999-0617	5566-16A2MS	16		46999-0624	5566-16A2MS-210	16		46999-0617	5566-16A2MS	16		46999-0624	5566-16A2MS-210	16																	
39-30-6187	5566 -18B2S	18		39-30-6188	5566 -18B2S-210	18		46999-0618	5566-18A2MS	18		50-34-8564	5566-18A2MS-210	18		46999-0618	5566-18A2MS	18		50-34-8564	5566-18A2MS-210	18		46999-0618	5566-18A2MS	18		50-34-8564	5566-18A2MS-210	18																	
39-30-6207	5566 -20B2S	20		39-30-6208	5566 -20B2S-210	20		50-34-8560	5566-20A2MS	20		50-34-2357	5566-20A2MS-210	20		50-34-8560	5566-20A2MS	20		50-34-2357	5566-20A2MS-210	20		50-34-8560	5566-20A2MS	20		50-34-2357	5566-20A2MS-210	20																	
39-30-6227	5566 -22B2S	22		39-30-6228	5566 -22B2S-210	22		46999-0619	5566-22A2MS	22		46999-0625	5566-22A2MS-210	22		46999-0619	5566-22A2MS	22		46999-0625	5566-22A2MS-210	22		46999-0619	5566-22A2MS	22		46999-0625	5566-22A2MS-210	22																	
39-30-6247	5566 -24B2S	24		39-30-6248	5566 -24B2S-210	24		46999-0620	5566-24A2MS	24		50-34-8566	5566-24A2MS-210	24		46999-0620	5566-24A2MS	24		50-34-8566	5566-24A2MS-210	24		46999-0620	5566-24A2MS	24		50-34-8566	5566-24A2MS-210	24																	
	-				-				-				-				-				-				-					-																	

12				11				10				9				8				7				6				5				4				3				2				1			
DOCUMENT STATUS				P1	RELEASE DATE				2020/12/14	16:13:38																																					

SYMBOLS  = 0  = 0  = 0  = 0  = 0  = 0  = 0  = 0	THIS DRAWING CONTAINS INFORMATION THAT IS PROPRIETARY TO MOLEX ELECTRONIC TECHNOLOGIES, LLC AND SHOULD NOT BE USED WITHOUT WRITTEN PERMISSION											
	DIMENSION UNITS IN/MM		SCALE									

12				11				10				9				8				7				6				5				4				3				2				1			
PLATING:				35 M.I. TIN				PLATING:				35 M.I. TIN				PLATING:								PLATING:																							
DRAIN HOLES:				WITHOUT DRAIN HOLES				DRAIN HOLES:				WITHOUT DRAIN HOLES				DRAIN HOLES:								DRAIN HOLES:																							
MTG. OPTION:				WITH PEGS				MTG. OPTION:				WITH PEGS				MTG. OPTION:								MTG. OPTION:																							
HOUSING MAT'L:				NYLON 6/6 94V-2 (BLACK)				HOUSING MAT'L:				NYLON 6/6 94V-0 NATURAL				HOUSING MAT'L:								HOUSING MAT'L:																							
PACKAGING:				PK-5566-001				PACKAGING:				55660000-RPK				PACKAGING:								PACKAGING:																							
PART NO.	ENG NO.	CKTS		PART NO.	ENG NO.	CKTS		PART NO.	ENG NO.	CKTS		PART NO.	ENG NO.	CKTS		PART NO.	ENG NO.	CKTS		PART NO.	ENG NO.	CKTS		PART NO.	ENG NO.	CKTS		PART NO.	ENG NO.	CKTS																	
	-			39-29-9300	5566-02A2-210TR	2	A1		-				-				-				-				-																						
39-31-9048	5566 -04A2-BL	4			-				-				-				-				-				-																						
	-				-				-				-				-				-				-																						
39-31-9088	5566 -08A2-BL	8			-				-				-				-				-				-																						
	-				-				-				-				-				-				-																						
	-				-				-				-				-				-				-																						
	-				-				-				-				-				-				-																						
	-				-				-				-				-				-				-																						
	-				-				-				-				-				-				-																						
	-				-				-				-				-				-				-																						
	-				-				-				-				-				-				-																						

PLATING:								PLATING:				100 M.I. MATTE TIN				PLATING:								PLATING:							
DRAIN HOLES:								DRAIN HOLES:				WITHOUT DRAIN HOLES				DRAIN HOLES:								DRAIN HOLES:							
MTG. OPTION:								MTG. OPTION:				WITH PEGS				MTG. OPTION:								MTG. OPTION:							
HOUSING MAT'L:								HOUSING MAT'L:				NYLON 6/6 94V-0 BLACK				HOUSING MAT'L:								HOUSING MAT'L:							
PACKAGING:								PACKAGING:				PK-5566-001				PACKAGING:								PACKAGING:							
PART NO.	ENG NO.	CKTS		PART NO.	ENG NO.	CKTS		PART NO.	ENG NO.	CKTS		PART NO.	ENG NO.	CKTS		PART NO.	ENG NO.	CKTS		PART NO.	ENG NO.	CKTS		PART NO.	ENG NO.	CKTS		PART NO.	ENG NO.	CKTS	
	-			46999-0335	5566-02A2MS-400	2			-				-				-				-				-						
	-			46999-0336	5566-04A2MS-400	4			-				-				-				-				-						
	-			46999-0337	5566-06A2MS-400	6			-				-				-				-				-						
	-			46999-0338	5566-08A2MS-400	8			-				-				-				-				-						
	-			46999-0339	5566-10A2MS-400	10			-				-				-				-				-						
	-			46999-0340	5566-12A2MS-400	12			-				-				-				-				-						
	-			46999-0341	5566-14A2MS-400	14			-				-				-				-				-						
	-			46999-0342	5566-16A2MS-400	16			-				-				-				-				-						
	-			46999-0343	5566-18A2MS-400	18			-				-				-				-				-						
	-			46999-0344	5566-20A2MS-400	20			-				-				-				-				-						
	-			46999-0345	5566-22A2MS-400	22			-				-				-				-				-						
	-			46999-0346	5566-24A2MS-400	24			-				-				-				-				-						
	-				-				-				-				-				-				-						
	-				-				-				-				-				-				-						

DOCUMENT STATUS				P1	RELEASE DATE	2020/12/14	16:13:38																																
-----------------	--	--	--	----	--------------	------------	----------	--	--	--	--	--	--	--	--	--	--	--	--	--	--	--	--	--	--	--	--	--	--	--	--	--	--	--	--	--	--	--	--

SYMBOLS												THIS DRAWING CONTAINS INFORMATION THAT IS PROPRIETARY TO MOLEX ELECTRONIC TECHNOLOGIES, LLC AND SHOULD NOT BE USED WITHOUT WRITTEN PERMISSION											
	= 0	IN/MM	SCALE	1:1	CURRENT REV DESC:																		
	= 0	GENERAL TOLERANCES (UNLESS SPECIFIED)		EC NO: 650997																			
	= 0	MM	INCH	DRWN: HPAN18 2020/10/23																			
	= 0	4 PLACES	±	±	CHK'D: YXZHENG 2020/12/14																		
	= 0	3 PLACES	±	± 0.015	APPR: YXZHENG 2020/12/14																		
	= 0	2 PLACES	±	± 0.38	INITIAL REVISION:																		
	= 0	1 PLACE	±	± 0.5	DRWN: RJF 1987/08/19																		
	= 0	0 PLACES	±	±	APPR: FSMITH 2012/01/10																		
	= 0	ANGULAR TOL	±	± 0.5 °	DRAFT WHERE APPLICABLE MUST REMAIN WITHIN DIMENSIONS																		
	= 0	THIRD ANGLE PROJECTION		DRAWING		SERIES		MATERIAL NUMBER		CUSTOMER		SHEET NUMBER											
	= 0			C-SIZE	5566	SEE TABLE	GENERAL MARKET	4 OF 4															

X-ON Electronics

Largest Supplier of Electrical and Electronic Components

Click to view similar products for [Headers & Wire Housings](#) category:

Click to view products by [Molex](#) manufacturer:

Other Similar products are found below :

[892-18-020-10-001101](#) [58102-G61-06LF](#) [582553-1](#) [0009485154](#) [009176003701906](#) [0050291907](#) [LY20-4P-DT1-P1E-BR](#) [02.125.8002.8](#)
[609-3404](#) [61062-3](#) [622-0430](#) [622-3653LF](#) [63453-116](#) [636-1030](#) [636-1427](#) [636-3427](#) [636-4007](#) [641938-9](#) [641991-4](#) [644827-2](#) [65817-010LF](#)
[65817-015LF](#) [65863-015LF](#) [66207-023LF](#) [67095-007LF](#) [67601157](#) [68648-049](#) [70.362.1628.0](#) [70-4210](#) [70-4226B](#) [70-4853B](#) [707-5020](#) [707-5028](#) [71.350.2428.0](#) [71918-208LF](#) [71961-016LF](#) [733-134](#) [733-162](#) [754199-000](#) [760-3052](#) [787-8014-00](#) [79531-3000](#) [FCN-360C032-B](#) [FCN-367T-T012/H](#) [FCN-723D010/2](#) [80.063.4001.1](#) [800-90-001-10-001000](#) [800-90-010-10-002000](#) [801-43-002-10-013000](#) [801-43-006-10-002000](#)