

PLEASE CHECK WWW.MOLEX.COM FOR LATEST PART INFORMATION

Part Number: **5031104000**
Status: **Active**
Overview: Duo-Clasp™ Wire-to-Board System
Description: 1.25mm Pitch Duo-Clasp Wire-to-Board Housing, Dual Row, Positive Lock, 40 Circuits

Documents:

3D Model	Application Specification AS-503110-001-001 (PDF)
Drawing (PDF)	Application Specification AS-503110-002-001 (PDF)
Product Specification PS-501931-002-001 (PDF)	Packaging Specification SPK-503110-001-001 (PDF)
Product Specification PS-501931-003-001 (PDF)	RoHS Certificate of Compliance (PDF)

Agency Certification

UL E29179

General

Product Family	Crimp Housings
Series	503110
Application	Signal, Wire-to-Board
Overview	Duo-Clasp™ Wire-to-Board System
Product Name	Duo-Clasp
UPC	800756934136

Physical

Breakaway	No
Circuits (maximum)	40
Color - Resin	White
Gender	Plug
Glow-Wire Compliant	No
Keying to Mating Part	Yes
Lock to Mating Part	Yes
Net Weight	552.000/mg
Number of Rows	2
Packaging Type	Bag
Panel Mount	No
Pitch - Mating Interface	1.25mm
Pitch - Termination Interface	1.25mm
Polarized to Mating Part	Yes
Ports	1
Stackable	No
Temperature Range - Operating	-25°C to +85°C

Electrical

Current - Maximum per Contact 1.0A

Material Info

Reference - Drawing Numbers

Application Specification	AS-503110-001-001, AS-503110-002-001
Packaging Specification	SPK-503110-001-001
Product Specification	PS-501931-002-001, PS-501931-003-001
Sales Drawing	SD-503110-001

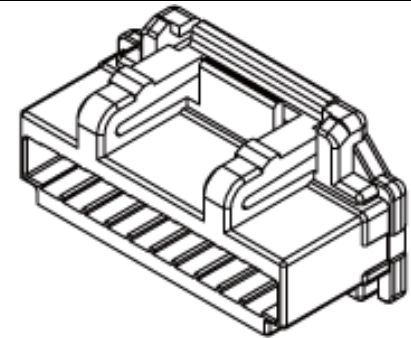

Series image - Reference only

EU ELV

Not Relevant

EU RoHS

Compliant

REACH SVHC

Not Contained Per -
ED/30/2017 (7 July
2017)

Halogen-Free

Status

Not Low-Halogen

**Need more information on product
environmental compliance?**

Email productcompliance@molex.com
Please visit the [Contact Us](#) section for any
non-product compliance questions.

China ROHS

ELV

RoHS Phthalates

Green Image

Not Relevant

Not Contained

Search Parts in this Series

[503110 Series](#)

Mates With

[501931 PCB Receptacle](#) . [502046 PCB Receptacle](#)

Use With

[501930 Crimp Terminal](#)

X-ON Electronics

Largest Supplier of Electrical and Electronic Components

Click to view similar products for [Headers & Wire Housings](#) category:

Click to view products by [Molex](#) manufacturer:

Other Similar products are found below :

[892-18-020-10-001101](#) [58102-G61-06LF](#) [582553-1](#) [0009485154](#) [009176003701906](#) [0050291907](#) [LY20-4P-DT1-P1E-BR](#) [02.125.8002.8](#)
[609-3404](#) [61062-3](#) [622-0430](#) [622-3653LF](#) [63453-116](#) [636-1030](#) [636-1427](#) [636-3427](#) [636-4007](#) [641938-9](#) [641991-4](#) [644827-2](#) [65817-010LF](#)
[65817-015LF](#) [65863-015LF](#) [66207-023LF](#) [67095-007LF](#) [67601157](#) [68648-049](#) [70.362.1628.0](#) [70-4210](#) [70-4226B](#) [70-4853B](#) [707-5020](#) [707-5028](#) [71.350.2428.0](#) [71918-208LF](#) [71961-016LF](#) [733-134](#) [733-162](#) [754199-000](#) [760-3052](#) [787-8014-00](#) [79531-3000](#) [FCN-360C032-B](#) [FCN-367T-T012/H](#) [FCN-723D010/2](#) [80.063.4001.1](#) [800-90-001-10-001000](#) [800-90-010-10-002000](#) [801-43-002-10-013000](#) [801-43-006-10-002000](#)