

PLEASE CHECK WWW.MOLEX.COM FOR LATEST PART INFORMATION

Part Number: **5037765010**
Status: **Active**
Overview: SlimStack™ 0.40mm Pitch Board-to-Board Connectors
Description: 0.40mm Pitch SlimStack B8 Board-to-Board Plug, Surface Mount, Dual Row, Vertical, 0.80mm Stacking Height, 50 Circuits

Documents:

3D Model	Application Specification AS-503772-001-001 (PDF)
Drawing (PDF)	Packaging Specification SPK-503776-001-001 (PDF)
Product Specification PS-503772-001-001 (PDF)	RoHS Certificate of Compliance (PDF)
Product Specification PS-503772-002-001 (PDF)	

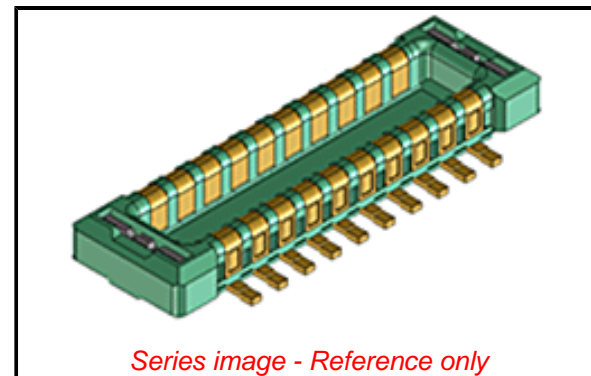

General

Product Family	PCB Headers
Series	503776
Application	Board-to-Board, Signal
Overview	SlimStack™ 0.40mm Pitch Board-to-Board Connectors
Product Name	SlimStack
Series Name	B8
UPC	884982408968

Physical

Breakaway	No
Circuits (Loaded)	50
Circuits (maximum)	50
Color - Resin	Black
Durability (mating cycles max)	30
Glow-Wire Capable	No
Lock to Mating Part	Yes
Mated Height	0.80mm
Mated Width	2.50mm
Material - Metal	Copper Alloy
Material - Plating Mating	Gold
Material - Plating Termination	Gold
Net Weight	20.886/mg
Number of Rows	2
Orientation	Vertical
PCB Locator	No
PCB Retention	Yes
Packaging Type	Embossed Tape on Reel
Pitch - Mating Interface	0.40mm
Polarized to Mating Part	No
Polarized to PCB	No
Stackable	No
Temperature Range - Operating	-40° to +85°C
Termination Interface: Style	Surface Mount

Electrical

Current - Maximum per Contact	0.3A
Voltage - Maximum	50V AC/DC

Material Info

Reference - Drawing Numbers

Application Specification	AS-503772-001-001
Packaging Specification	SPK-503776-001-001
Product Specification	PS-503772-001-001, PS-503772-002-001
Sales Drawing	5037760000-000, 5037761000-000

EU ELV

Not Relevant

EU RoHS

Compliant

REACH SVHC

Not Contained Per -
ED/61/2018 (27 June
2018)

Halogen-Free

Status

Low-Halogen

**Need more information on product
environmental compliance?**

Email productcompliance@molex.com
Please visit the [Contact Us](#) section for any
non-product compliance questions.

China ROHS

ELV

RoHS Phthalates

Green Image

Not Relevant

Not Contained

Search Parts in this Series

503776 Series

Mates With

SlimStack B8 Board-to-Board Receptacle
503772-5010

This document was generated on 08/14/2018

PLEASE CHECK WWW.MOLEX.COM FOR LATEST PART INFORMATION

X-ON Electronics

Largest Supplier of Electrical and Electronic Components

Click to view similar products for [Board to Board & Mezzanine Connectors](#) category:

Click to view products by [Molex](#) manufacturer:

Other Similar products are found below :

[589158040000018](#) [MDF7C-18P-2.54DSA\(55\)](#) [FCN-230C068-11](#) [FCN-268F012-G/BD](#) [FCN-268F036-G/BD](#) [FCN-268M012-G/0D](#) [FCN-268M024-G/1D](#) [FCN-723J004/1](#) [MIS-048-01-F-D-DP-K](#) [832-10-034-10-001000](#) [FX4C-80S-1.27DSA](#) [FCN-214Q030-G/0](#) [FCN-234P048-G/0](#) [FCN-235D050-G/C](#) [2-22603-0](#) [AXG720047](#) [5031084030](#) [MIT-114-03-F-D-K](#) [55323-1519](#) [YFT-20-05-H-03-SB-K](#) [503308-3040](#) [026-6203-PDB](#) [027-6203-PDB](#) [069159702701000](#) [10123981-102LF](#) [101A10019X](#) [55650-0588-C](#) [68682-310LF](#) [68684-306](#) [75140-7012](#) [87471-650](#) [194261-1](#) [FCN-268F024-G0D](#) [10124054-515LF](#) [68685-603](#) [8-1616154-3](#) [MIS-019-01-F-D](#) [FCN-268M024-G/3D](#) [FCN-268M036-G/BD](#) [20021832-06016C1LF](#) [KX15-20KLDL-E1000E](#) [AXE810124](#) [FCN-214J100-G/0](#) [FCN-230C068-E/S](#) [AXE812124](#) [AXE816124](#) [AXE720127](#) [354184](#) [MIT-019-04-F-D-K](#) [P50-028-DDS-TG](#)