

PLEASE CHECK WWW.MOLEX.COM FOR LATEST PART INFORMATION

Part Number: [0554542070](#)
Status: **Active**
Description: 1.25mm Pitch Mi II System Wire-to-Board Header, Single Row, Right-Angle, 20 Circuits

Documents:

[3D Model](#) [Product Specification PS-54596-018-001 \(PDF\)](#)
[Drawing \(PDF\)](#) [RoHS Certificate of Compliance \(PDF\)](#)

General

Product Family PCB Headers
 Series [55454](#)
 Application Signal, Wire-to-Board
 Product Name Mini Mi II
 UPC 756054761137

Physical

Breakaway No
 Circuits (Loaded) 20
 Circuits (maximum) 20
 Color - Resin Natural
 Durability (mating cycles max) 30
 First Mate / Last Break No
 Glow-Wire Capable No
 Guide to Mating Part No
 Keying to Mating Part None
 Lock to Mating Part Yes
 Material - Plating Mating Tin
 Material - Plating Termination Tin
 Net Weight 837.100/mg
 Number of Rows 1
 Orientation Right Angle
 PC Tail Length 3.00mm
 PCB Locator Yes
 PCB Retention Yes
 PCB Thickness - Recommended 1.60mm
 Packaging Type Tray
 Pitch - Mating Interface 1.25mm
 Polarized to Mating Part Yes
 Shrouded Fully
 Stackable No
 Surface Mount Compatible (SMC) No
 Temperature Range - Operating -40° to +105°C
 Termination Interface: Style Through Hole

Electrical

Current - Maximum per Contact 1.5A
 Voltage - Maximum 100V

Material Info

Reference - Drawing Numbers

Product Specification PS-54596-018-001
 Sales Drawing SD-55454-007

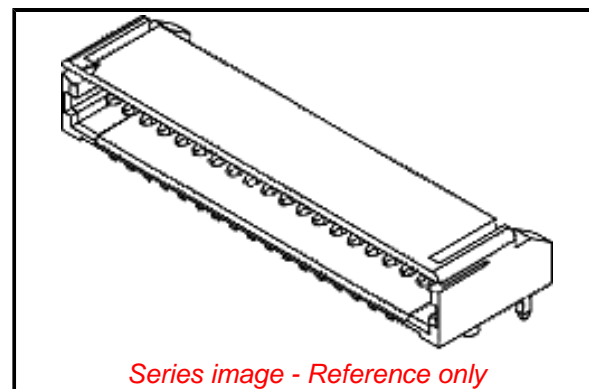

EU ELV

Not Relevant

EU RoHS

Compliant

REACH SVHC

Not Contained Per -
 ED/61/2018 (27 June
 2018)

Halogen-Free

Status

Not Low-Halogen

**Need more information on product
 environmental compliance?**

Email productcompliance@molex.com
 Please visit the [Contact Us](#) section for any
 non-product compliance questions.

China ROHS

ELV

Prop65

RoHS Phthalates

China RoHS

Green Image

Not Relevant

Compliant

Not Contained

Search Parts in this Series

[55454 Series](#)

Mates With

[51336 PBT Polyester, Glass-filled Housing,](#)
[54596 PA Polyamide Housing](#)

X-ON Electronics

Largest Supplier of Electrical and Electronic Components

Click to view similar products for [Headers & Wire Housings](#) category:

Click to view products by [Molex](#) manufacturer:

Other Similar products are found below :

[892-18-020-10-001101](#) [58102-G61-06LF](#) [582553-1](#) [0009485154](#) [009176003701906](#) [0050291907](#) [LY20-4P-DT1-P1E-BR](#) [02.125.8002.8](#)
[609-3404](#) [61062-3](#) [622-0430](#) [622-3653LF](#) [63453-116](#) [636-1030](#) [636-1427](#) [636-3427](#) [636-4007](#) [641938-9](#) [641991-4](#) [644827-2](#) [65817-010LF](#)
[65817-015LF](#) [65863-015LF](#) [66207-023LF](#) [67095-007LF](#) [67601157](#) [68648-049](#) [70.362.1628.0](#) [70-4210](#) [70-4226B](#) [70-4853B](#) [707-5020](#) [707-](#)
[5028](#) [71.350.2428.0](#) [71918-208LF](#) [71961-016LF](#) [733-134](#) [733-162](#) [754199-000](#) [760-3052](#) [787-8014-00](#) [79531-3000](#) [FCN-360C032-B](#) [FCN-](#)
[367T-T012/H](#) [FCN-723D010/2](#) [80.063.4001.1](#) [800-90-001-10-001000](#) [800-90-010-10-002000](#) [801-43-002-10-013000](#) [801-43-006-10-002000](#)