

**ALTERNATIVE CORING  
MANUFACTURER'S OPTION**

CKT. SIZE	DIM. "A"		DIM. "B"	
	MM	IN.	MM	IN.
2	2.54	.100	5.33±0.08	.210±.003
3	5.08	.200	8.13±0.10	.320±.004
4	7.62	.300	10.67±0.10	.420±.004
5	10.16	.400	13.21±0.10	.520±.004
6	12.70	.500	15.75±0.10	.620±.004
7	15.24	.600	18.29±0.10	.720±.004
8	17.78	.700	20.83±0.10	.820±.004
9	20.32	.800	23.37±0.10	.920±.004
10	22.86	.900	25.91±0.13	1.020±.005
11	25.40	1.000	28.45±0.13	1.120±.005
12	27.94	1.100	30.99±0.13	1.220±.005
13	30.48	1.200	33.53±0.13	1.320±.005
14	33.02	1.300	36.07±0.13	1.420±.005
15	35.56	1.400	38.61±0.15	1.520±.006
16	38.10	1.500	41.15±0.15	1.620±.006
17	40.64	1.600	43.69±0.15	1.720±.006
18	43.18	1.700	46.23±0.15	1.820±.006
19	45.72	1.800	48.77±0.18	1.920±.007
20	48.26	1.900	51.31±0.18	2.020±.007
21	50.80	2.000	53.85±0.18	2.120±.007
22	53.34	2.100	56.39±0.18	2.220±.007
23	55.88	2.200	58.93±0.18	2.320±.007
24	58.42	2.300	61.47±0.18	2.420±.007
25	60.96	2.400	64.01±0.20	2.520±.008

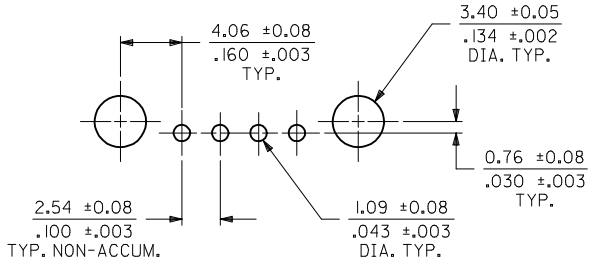

**RECOMMENDED PC BOARD LAYOUT**  
(FOR USE WITH 1.57 / .062 THICK BOARD)

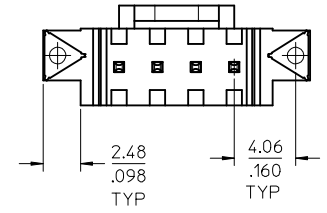
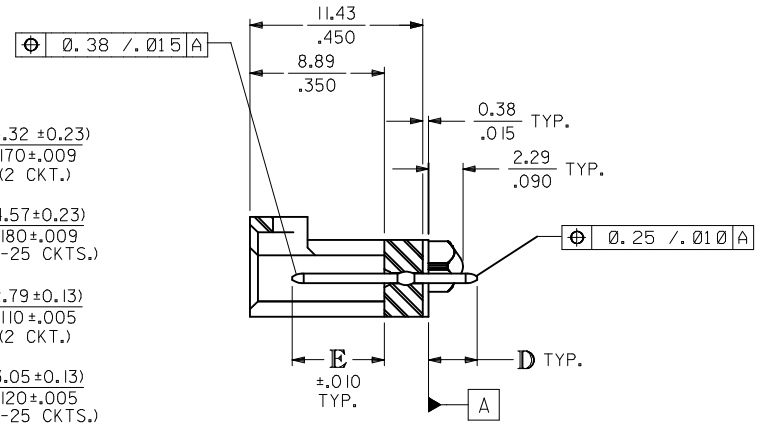
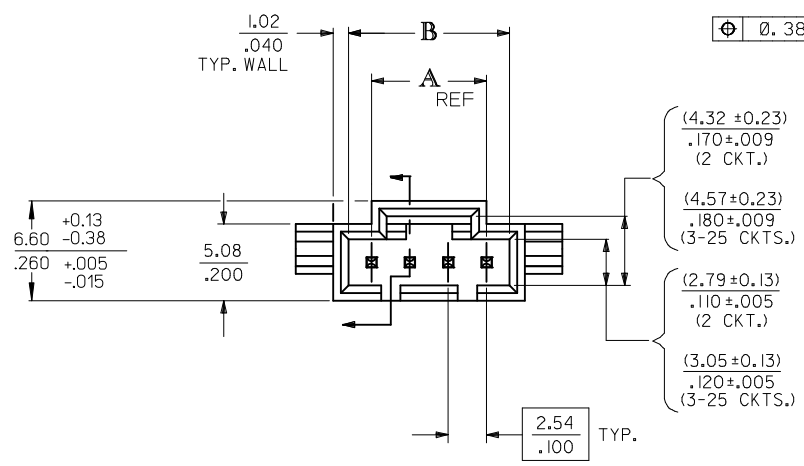
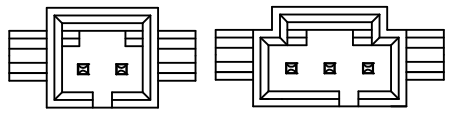

**2 CIRCUIT      3 CIRCUIT**

- NOTES:
1. HEADER MATERIAL: GLASS FILLED POLYESTER, UL94V-0; COLOR: BLACK  
PIN MATERIAL: PHOSPHOR BRONZE
  2. FINISH:  
TIN - 0.00381/.000150 MIN TIN PLATE  
OVER 0.00127/.000050 MIN NICKEL PLATE  
15 GOLD - 0.00038/.000015 MIN GOLD PLATE IN SELECT AREA,  
0.00191/.000075 MIN TIN PLATE IN SELECT AREA,  
OVER 0.00127/.000050 MIN NICKEL PLATE OVERALL.  
30 GOLD - 0.00076/.000030 MIN GOLD PLATE IN SELECT AREA,  
0.00191/.000075 MIN TIN PLATE IN SELECT AREA,  
OVER 0.00127/.000050 MIN NICKEL PLATE OVERALL.  
\* THE PRIMARY SHIPPING CARTON WILL BE LABELED "COMPLIANT TO RoHS  
DIRECTIVE 2002/95/EC AND ELV ANNEX II OF DIRECTIVE 2000/53/EC."  
CARTONS WITHOUT THIS LABEL MAY CONTAIN PRODUCT WITH LEAD.
  3. PRODUCT SPECIFICATION: PS-70541
  4. PACKAGING SPECIFICATION: PK-70873-0014
  5. HEADER TO BE USED WITH OPTION "G" 70400 AND 70430 SERIES SL CONNECTORS.

ADD .098 AND .160 EC NO: UCP2017-1091 DRWINKSMIEC 2016/11/11 CHKD: APPR:FSMITH 2016/12/29	QUALITY SYMBOLS ▽=0 ▽=0 ▽=0	GENERAL TOLERANCES (UNLESS SPECIFIED)	DIMENSION STYLE		SCALE 4:1	DESIGN UNITS INCH	THIRD ANGLE PROJECTION
			mm	INCH			
M	DESCRIPTION	DRAWN BY AAB	DATE 05/12/93		TITLE	SALES ASSY, SL VERTICAL HEADER W/LATCH&TRI-PEGS (2.54)/.100 CENTERS	DOCUMENT NO. SDA-70545-****
			DATE 05/12/93				
REV	APPROVED BY SMILLER	DATE 2013/07/22		MATERIAL NO.	SEE TABLE	SHEET NO. 1 OF 4	
		DATE 2013/07/22					
DRAFT WHERE APPLICABLE MUST REMAIN WITHIN DIMENSIONS		ANGULAR ±1/2°		THIS DRAWING CONTAINS INFORMATION THAT IS PROPRIETARY TO MOLEX INCORPORATED AND SHOULD NOT BE USED WITHOUT WRITTEN PERMISSION			

# OPTIONAL HOUSING

## WEBBED KEYING FEATURES

20 CKT HEADER  
SHOWN FOR REFERENCE

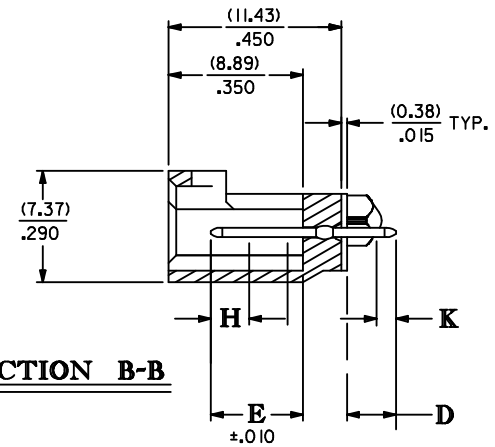
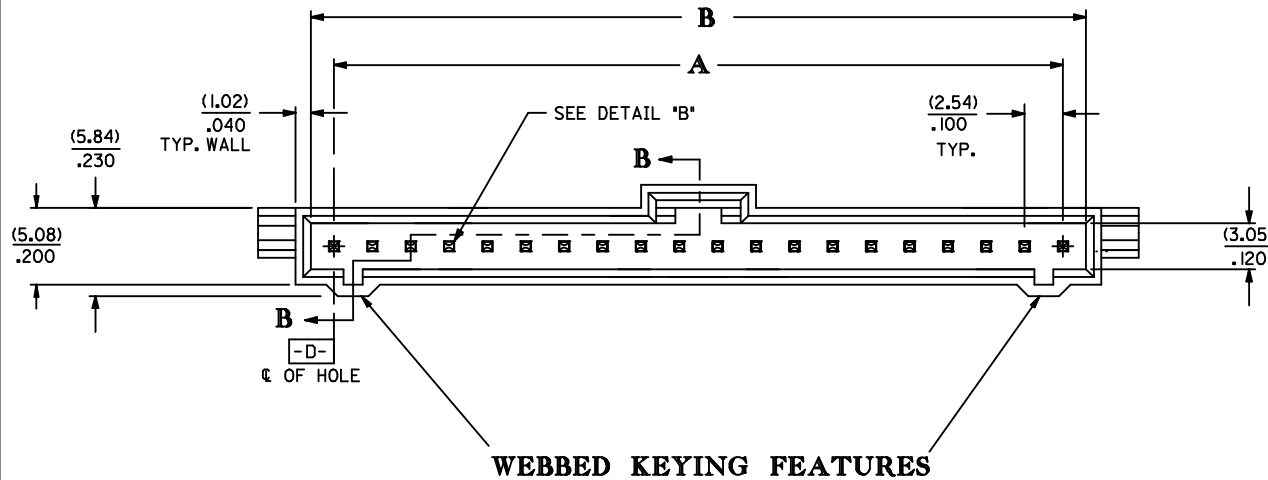
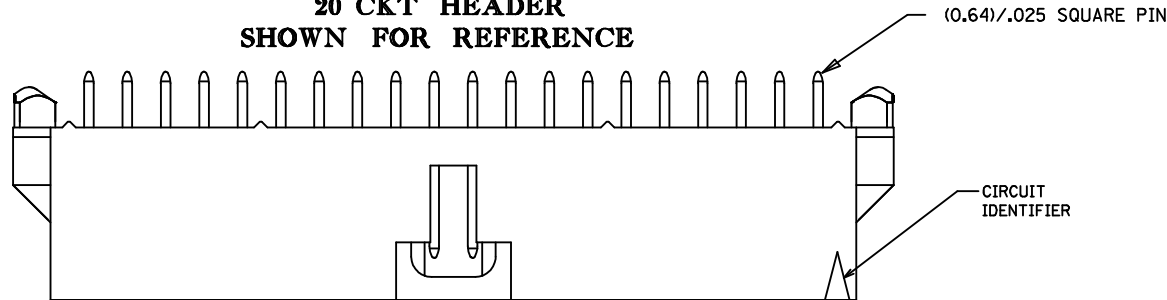

**SECTION B-B**

SEE SHEET 1 EC NO: UCP2017-1091 DRW:KSM/IEC 2016/11/11 CHKD: APPR:FSM/TH 2016/12/29 M	QUALITY SYMBOLS ∇=0 ∇=0 ∇=0	GENERAL TOLERANCES (UNLESS SPECIFIED) 4 PLACES ± --- ± --- 3 PLACES ± --- ± .005 2 PLACES ± 0.13 ± .01 1 PLACE ± 0.25 ± --- 0 PLACE ± --- ± ---	DIMENSION STYLE MM/IN	SCALE INCH	DESIGN UNITS INCH	THIRD ANGLE PROJECTION
	DRAWN BY AAB	DATE 05/12/93	TITLE SALES ASSY, SL VERTICAL HEADER W/LATCH&TRI-PEGS (2.54)/.100 CENTERS	molex		
	CHECKED BY MJM	DATE 05/12/93	APPROVED BY SMILLER			
	DRAFT WHERE APPLICABLE MUST REMAIN WITHIN DIMENSIONS		ANGULAR ±1/2°	MATERIAL NO. SEE TABLE	DOCUMENT NO. SDA-70545-****	SHEET NO. 2 OF 4

CIRCUIT SIZE	ASSEMBLY ITEM NUMBER 70545		<b>D</b> (± 0.38) ± .015	<b>E</b> (± 0.25) ± .010	MATING AREA FINISH	PC TAIL AREA FINISH
2-10	-0001-0009		(3.30) .130	(6.10) .240	TIN	TIN
11-25	-0010-0024		(3.30) .130	(6.10) .240	TIN	TIN
2-10	-0036-0044		(3.30) .130	(6.10) .240	15 GOLD	TIN
11-25	-0045-0059		(3.30) .130	(6.10) .240	15 GOLD	TIN
2-10	-0071-0079		(3.30) .130	(6.10) .240	30 GOLD	TIN
11-25	-0080-0094		(3.30) .130	(6.10) .240	30 GOLD	TIN
2-10	-0141-0149		(5.21) .205	(6.10) .240	15 GOLD	TIN
11-25	-0150-0164		(5.21) .205	(6.10) .240	15 GOLD	TIN
2-10	-0176-0184		(5.21) .205	(6.10) .240	30 GOLD	TIN
11-25	-0185-0199		(5.21) .205	(6.10) .240	30 GOLD	TIN

CIRCUIT SIZE	ASSEMBLY ITEM NUMBER	ASSEMBLY ITEM NUMBER	ASSEMBLY ITEM NUMBER	ASSEMBLY ITEM NUMBER	ASSEMBLY ITEM NUMBER
2	70545-0001	70545-0036	70545-0071	70545-0141	70545-0176
3	70545-0002	70545-0037	70545-0072	70545-0142	70545-0177
4	70545-0003	70545-0038	70545-0073	70545-0143	70545-0178
5	70545-0004	70545-0039	70545-0074	70545-0144	70545-0179
6	70545-0005	70545-0040	70545-0075	70545-0145	70545-0180
7	70545-0006	70545-0041	70545-0076	70545-0146	70545-0181
8	70545-0007	70545-0042	70545-0077	70545-0147	70545-0182
9	70545-0008	70545-0043	70545-0078	70545-0148	70545-0183
10	70545-0009	70545-0044	70545-0079	70545-0149	70545-0184
11	70545-0010	70545-0045	70545-0080		
12	70545-0011	70545-0046	70545-0081		
13	70545-0012	70545-0047	70545-0082		
14	70545-0013	70545-0048	70545-0083		
15	70545-0014	70545-0049	70545-0084		
16	70545-0015	70545-0050	70545-0085		
17	70545-0016	70545-0051	70545-0086		
18	70545-0017	70545-0052	70545-0087		
19	70545-0018	70545-0053	70545-0088		
20	70545-0019	70545-0054	70545-0089		
21	70545-0020	70545-0055	70545-0090		
22	70545-0021	70545-0056	70545-0091		
23	70545-0022	70545-0057	70545-0092		
24	70545-0023	70545-0058	70545-0093		
25	70545-0024	70545-0059	70545-0094		

<b>SEE SHEET 1</b> EC NO: UCP2017-1091 DRWNG:SMIEC 2016/11/11 CHKD: APPR:FSMITH 2016/12/29 DESCRIPTION REV	QUALITY SYMBOLS	GENERAL TOLERANCES (UNLESS SPECIFIED)	DIMENSION STYLE MM/IN	SCALE	DESIGN UNITS INCH	THIRD ANGLE PROJECTION
	▽=0	4 PLACES ± --- ± ---	DRAWN BY DATE AAB 05/12/93	TITLE	<b>SALES ASSY, SL VERTICAL HEADER W/LATCH&amp;TRI-PEGS (2.54)/.100 CENTERS</b> <b>molex</b> DOCUMENT NO. SDA-70545-**** SHEET NO. 3 OF 4	
	▽=0	3 PLACES ± --- ± .005	CHECKED BY DATE MJM 05/12/93			
	▽=0	2 PLACES ± 0.13 ± .01	APPROVED BY DATE SMILLER 2013/07/22			
	1 PLACE ± 0.25 ± ---	MATERIAL NO.				
	0 PLACE ± --- ± ---	ANGULAR ±1/2°	SEE TABLE			
		DRAFT WHERE APPLICABLE MUST REMAIN WITHIN DIMENSIONS	SIZE C	THIS DRAWING CONTAINS INFORMATION THAT IS PROPRIETARY TO MOLEX INCORPORATED AND SHOULD NOT BE USED WITHOUT WRITTEN PERMISSION		

CIRCUIT SIZE	ASSEMBLY ITEM NUMBER 70545		D REF.	E ± .010	MATING AREA FINISH	PC TAIL AREA FINISH
2-19	-3001-3018	WEBBED ASSEMBLY	(3.30) .130	(6.10) .240	30 GOLD	TIN
20-25	-3019-3024	WEBBED ASSEMBLY	(3.30) .130	(6.10) .240	30 GOLD	TIN
2-19	-3051-3068	WEBBED ASSEMBLY	(3.30) .130	(6.10) .240	15 GOLD	TIN
20-25	-3069-3074	WEBBED ASSEMBLY	(3.30) .130	(6.10) .240	15 GOLD	TIN
2-19	-3101-3118	WEBBED ASSEMBLY	(3.30) .130	(6.10) .240	TIN	TIN
20-25	-3119-3124	WEBBED ASSEMBLY	(3.30) .130	(6.10) .240	TIN	TIN

CIRCUIT SIZE	WEBBED ASSEMBLY ITEM NUMBER	WEBBED ASSEMBLY ITEM NUMBER	WEBBED ASSEMBLY ITEM NUMBER
2			
3			
4			
5			
6			
7			
8			
9			
10			
11			
12			
13			
14			
15			
16			
17			
18			
19			
20	70545-3019	70545-3069	70545-3119
21	70545-3020	70545-3070	70545-3120
22	70545-3021	70545-3071	70545-3121
23	70545-3022	70545-3072	70545-3122
24	70545-3023	70545-3073	70545-3123
25	70545-3024	70545-3074	70545-3124

SEE SHEET 1 EC NO: UCP2017-1091 DRINKSMIEC 2016/11/11 CHKD: APPR:FSM/TH 2016/12/29 M	DESCRIPTION QUALITY SYMBOLS □=0 □=0 □=0	GENERAL TOLERANCES (UNLESS SPECIFIED)		DIMENSION STYLE MM/IN		SCALE	DESIGN UNITS INCH	THIRD ANGLE PROJECTION		
				mm	INCH	DRAWN BY AAB	DATE 05/12/93	TITLE SALES ASSY, SL VERTICAL HEADER W/LATCH&TRI-PEGS (2.54)/.100 CENTERS		
				4 PLACES ± ---	± ---	CHECKED BY MJM	DATE 05/12/93			
				2 PLACES ± 0.13	± .01	APPROVED BY SMILLER	DATE 2013/07/22	mox DOCUMENT NO. SDA-70545-**** SHEET NO. 4 OF 4		
		1 PLACE ± 0.25	± ---	MATERIAL NO.						
		0 PLACE ± ---	± ---	ANGULAR ±1/2°		DRAFT WHERE APPLICABLE MUST REMAIN WITHIN DIMENSIONS				
				SIZE C	THIS DRAWING CONTAINS INFORMATION THAT IS PROPRIETARY TO MOLEX INCORPORATED AND SHOULD NOT BE USED WITHOUT WRITTEN PERMISSION					

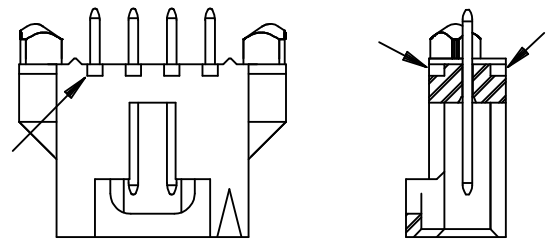
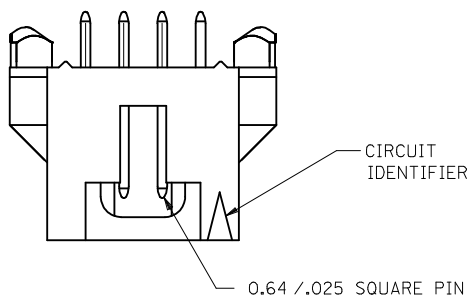

**ALTERNATIVE CORING  
MANUFACTURER'S OPTION**

CKT. SIZE	DIM. "A"		DIM. "B"	
	MM	IN.	MM	IN.
2	2.54	.100	5.33±0.08	.210±.003
3	5.08	.200	8.13±0.10	.320±.004
4	7.62	.300	10.67±0.10	.420±.004
5	10.16	.400	13.21±0.10	.520±.004
6	12.70	.500	15.75±0.10	.620±.004
7	15.24	.600	18.29±0.10	.720±.004
8	17.78	.700	20.83±0.10	.820±.004
9	20.32	.800	23.37±0.10	.920±.004
10	22.86	.900	25.91±0.13	1.020±.005
11	25.40	1.000	28.45±0.13	1.120±.005
12	27.94	1.100	30.99±0.13	1.220±.005
13	30.48	1.200	33.53±0.13	1.320±.005
14	33.02	1.300	36.07±0.13	1.420±.005
15	35.56	1.400	38.61±0.15	1.520±.006
16	38.10	1.500	41.15±0.15	1.620±.006
17	40.64	1.600	43.69±0.15	1.720±.006
18	43.18	1.700	46.23±0.15	1.820±.006
19	45.72	1.800	48.77±0.18	1.920±.007
20	48.26	1.900	51.31±0.18	2.020±.007
21	50.80	2.000	53.85±0.18	2.120±.007
22	53.34	2.100	56.39±0.18	2.220±.007
23	55.88	2.200	58.93±0.18	2.320±.007
24	58.42	2.300	61.47±0.18	2.420±.007
25	60.96	2.400	64.01±0.20	2.520±.008

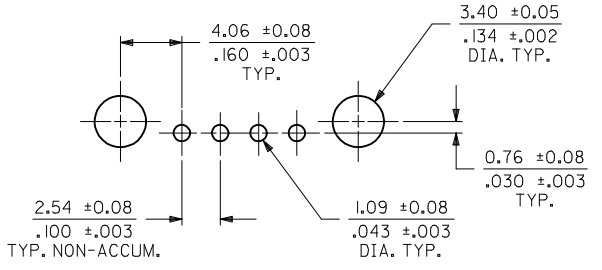
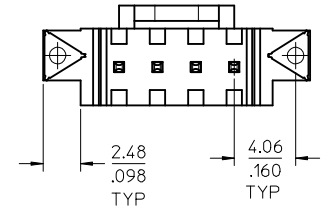
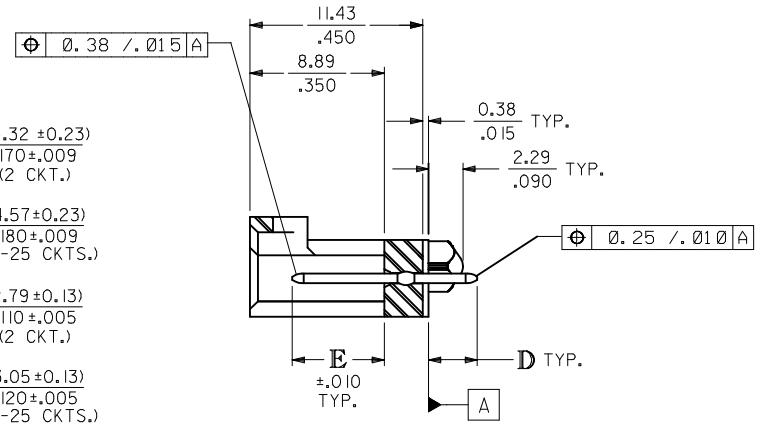
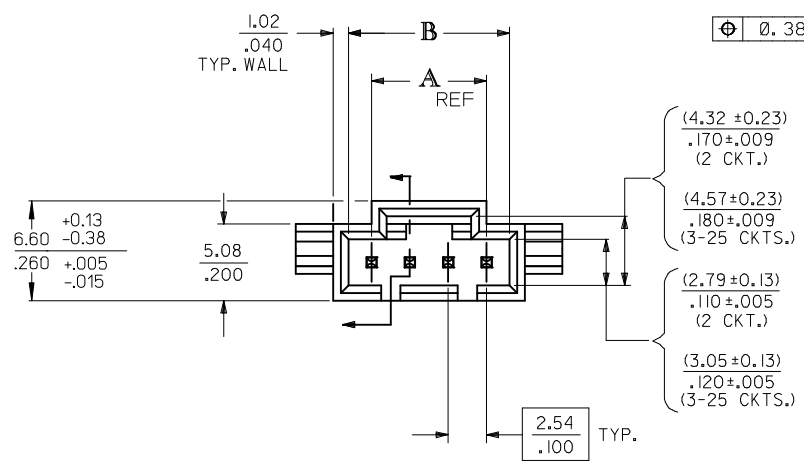

**RECOMMENDED PC BOARD LAYOUT**  
(FOR USE WITH 1.57 / .062 THICK BOARD)

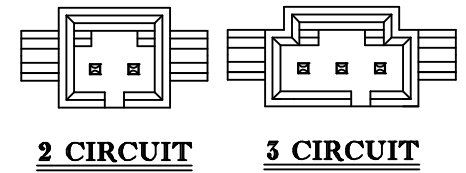

- NOTES:
- HEADER MATERIAL: GLASS FILLED POLYESTER, UL94V-0; COLOR: BLACK  
PIN MATERIAL: PHOSPHOR BRONZE
  - FINISH:  
TIN - 0.00381/.000150 MIN TIN PLATE  
OVER 0.00127/.000050 MIN NICKEL PLATE  
15 GOLD - 0.00038/.000015 MIN GOLD PLATE IN SELECT AREA,  
0.00191/.000075 MIN TIN PLATE IN SELECT AREA,  
OVER 0.00127/.000050 MIN NICKEL PLATE OVERALL.  
30 GOLD - 0.00076/.000030 MIN GOLD PLATE IN SELECT AREA,  
0.00191/.000075 MIN TIN PLATE IN SELECT AREA,  
OVER 0.00127/.000050 MIN NICKEL PLATE OVERALL.  
\* THE PRIMARY SHIPPING CARTON WILL BE LABELED "COMPLIANT TO RoHS  
DIRECTIVE 2002/95/EC AND ELV ANNEX II OF DIRECTIVE 2000/53/EC."  
CARTONS WITHOUT THIS LABEL MAY CONTAIN PRODUCT WITH LEAD.
  - PRODUCT SPECIFICATION: PS-70541
  - PACKAGING SPECIFICATION: PK-70873-0014
  - HEADER TO BE USED WITH OPTION "G" 70400 AND 70430 SERIES SL CONNECTORS.

ADD .098 AND .160 EC NO: UCP2017-1091 DRWINKSMIEC 2016/11/11 CHKD: APPR:FSMITH 2016/12/29 REV: M	QUALITY SYMBOLS	GENERAL TOLERANCES (UNLESS SPECIFIED)	DIMENSION STYLE	SCALE	DESIGN UNITS	THIRD ANGLE PROJECTION
	▽=0	mm INCH	MM/IN	4:1	INCH	
	▽=0	4 PLACES ± --- ± ---	DRAWN BY DATE			
	▽=0	3 PLACES ± --- ± .005	AAB 05/12/93			
		2 PLACES ± 0.13 ± .01	CHECKED BY DATE			
		1 PLACE ± 0.25 ± ---	MJM 05/12/93			
		0 PLACE ± --- ± ---	APPROVED BY DATE			
		ANGULAR ±1/2°	SMILLER 2013/07/22			
		DRAFT WHERE APPLICABLE MUST REMAIN WITHIN DIMENSIONS	MATERIAL NO.			
			SEE TABLE			
			SIZE C			
			THIS DRAWING CONTAINS INFORMATION THAT IS PROPRIETARY TO MOLEX INCORPORATED AND SHOULD NOT BE USED WITHOUT WRITTEN PERMISSION			

SALES ASSY, SL VERTICAL  
HEADER W/LATCH&TRI-PEGS  
(2.54) / .100 CENTERS

**molex**

DOCUMENT NO. SDA-70545-\*\*\*\*

SHEET NO. 1 OF 4

# OPTIONAL HOUSING

## WEBBED KEYING FEATURES

20 CKT HEADER  
SHOWN FOR REFERENCE

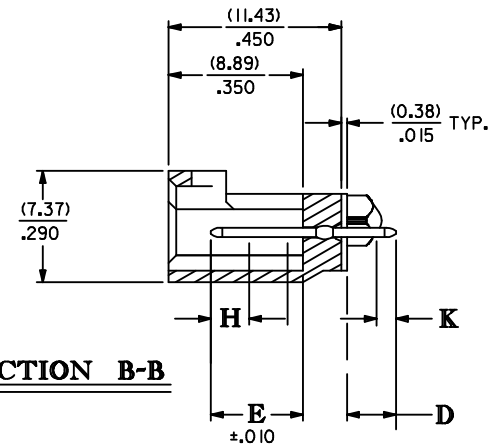
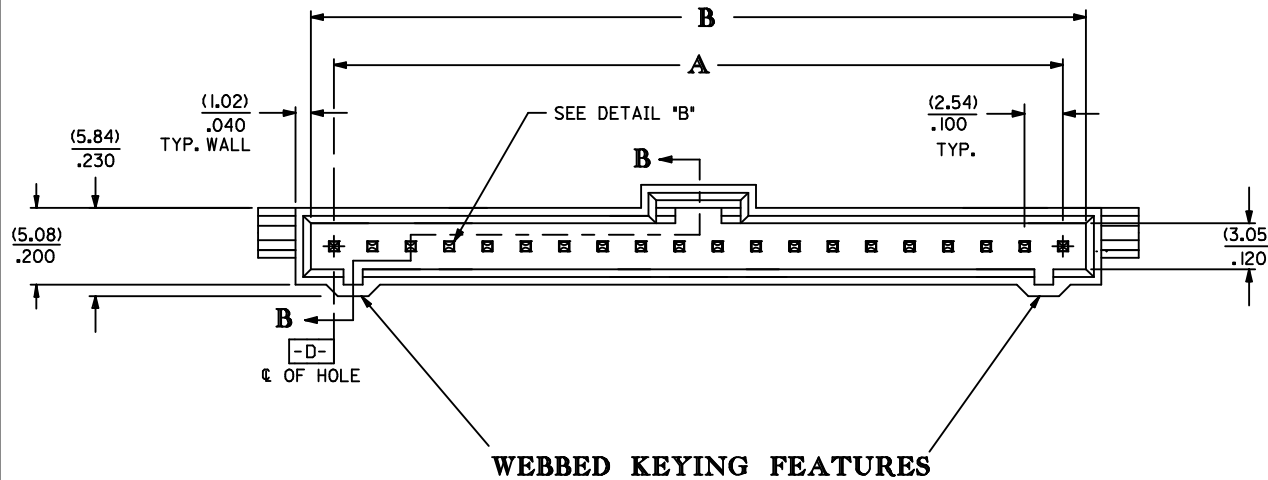
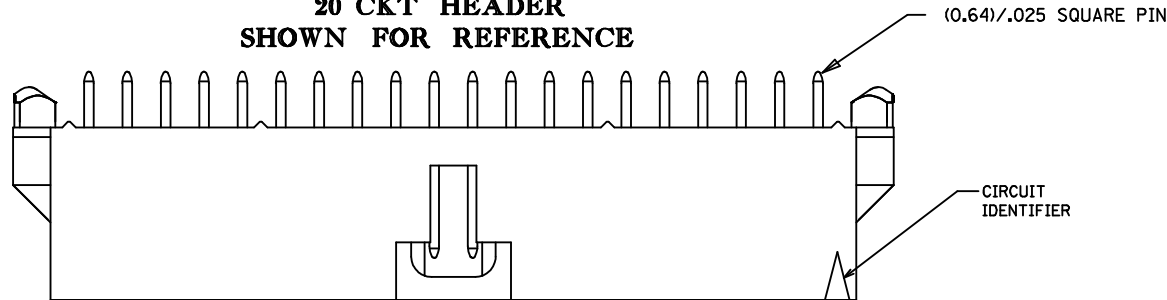

**SECTION B-B**

SEE SHEET 1 EC NO: UCP2017-1091 DRW:KSM/IEC 2016/11/11 CHKD: APPR:FSM/ITH 2016/12/29	QUALITY SYMBOLS ▽=0 ▽=0 ▽=0	GENERAL TOLERANCES (UNLESS SPECIFIED)		DIMENSION STYLE	SCALE	DESIGN UNITS	THIRD ANGLE PROJECTION	
		mm	INCH	MM/IN	INCH	INCH		
M	DESCRIPTION	4 PLACES	± .005	DRAWN BY	DATE	TITLE		
		3 PLACES	± .005	AAB	05/12/93	SALES ASSY, SL VERTICAL HEADER W/LATCH&TRI-PEGS (2.54)/.100 CENTERS		
		2 PLACES	± 0.13	± .01	CHECKED BY	DATE	DOCUMENT NO. SDA-70545-**** SHEET NO. 2 OF 4	
		1 PLACE	± 0.25	± .01	MJM	05/12/93		
		0 PLACE	± .005	± .01	APPROVED BY	DATE		
				SMILLER	2013/07/22	molex		
				MATERIAL NO. SEE TABLE				
DRAFT WHERE APPLICABLE MUST REMAIN WITHIN DIMENSIONS		ANGULAR ±1/2°		SIZE C		THIS DRAWING CONTAINS INFORMATION THAT IS PROPRIETARY TO MOLEX INCORPORATED AND SHOULD NOT BE USED WITHOUT WRITTEN PERMISSION		

CIRCUIT SIZE	ASSEMBLY ITEM NUMBER 70545		<b>D</b> (± 0.38) ± .015	<b>E</b> (± 0.25) ± .010	MATING AREA FINISH	PC TAIL AREA FINISH
2-10	-0001-0009		(3.30) .130	(6.10) .240	TIN	TIN
11-25	-0010-0024		(3.30) .130	(6.10) .240	TIN	TIN
2-10	-0036-0044		(3.30) .130	(6.10) .240	15 GOLD	TIN
11-25	-0045-0059		(3.30) .130	(6.10) .240	15 GOLD	TIN
2-10	-0071-0079		(3.30) .130	(6.10) .240	30 GOLD	TIN
11-25	-0080-0094		(3.30) .130	(6.10) .240	30 GOLD	TIN
2-10	-0141-0149		(5.21) .205	(6.10) .240	15 GOLD	TIN
11-25	-0150-0164		(5.21) .205	(6.10) .240	15 GOLD	TIN
2-10	-0176-0184		(5.21) .205	(6.10) .240	30 GOLD	TIN
11-25	-0185-0199		(5.21) .205	(6.10) .240	30 GOLD	TIN

CIRCUIT SIZE	ASSEMBLY ITEM NUMBER	ASSEMBLY ITEM NUMBER	ASSEMBLY ITEM NUMBER	ASSEMBLY ITEM NUMBER	ASSEMBLY ITEM NUMBER
2	70545-0001	70545-0036	70545-0071	70545-0141	70545-0176
3	70545-0002	70545-0037	70545-0072	70545-0142	70545-0177
4	70545-0003	70545-0038	70545-0073	70545-0143	70545-0178
5	70545-0004	70545-0039	70545-0074	70545-0144	70545-0179
6	70545-0005	70545-0040	70545-0075	70545-0145	70545-0180
7	70545-0006	70545-0041	70545-0076	70545-0146	70545-0181
8	70545-0007	70545-0042	70545-0077	70545-0147	70545-0182
9	70545-0008	70545-0043	70545-0078	70545-0148	70545-0183
10	70545-0009	70545-0044	70545-0079	70545-0149	70545-0184
11	70545-0010	70545-0045	70545-0080		
12	70545-0011	70545-0046	70545-0081		
13	70545-0012	70545-0047	70545-0082		
14	70545-0013	70545-0048	70545-0083		
15	70545-0014	70545-0049	70545-0084		
16	70545-0015	70545-0050	70545-0085		
17	70545-0016	70545-0051	70545-0086		
18	70545-0017	70545-0052	70545-0087		
19	70545-0018	70545-0053	70545-0088		
20	70545-0019	70545-0054	70545-0089		
21	70545-0020	70545-0055	70545-0090		
22	70545-0021	70545-0056	70545-0091		
23	70545-0022	70545-0057	70545-0092		
24	70545-0023	70545-0058	70545-0093		
25	70545-0024	70545-0059	70545-0094		

<b>SEE SHEET 1</b> EC NO: UCP2017-1091 DRWNG:SM/EC 2016/11/11 CHKD: APPR:FSM/TH 2016/12/29 DESCRIPTION REV	QUALITY SYMBOLS	GENERAL TOLERANCES (UNLESS SPECIFIED)	DIMENSION STYLE MM/IN		SCALE	DESIGN UNITS INCH	THIRD ANGLE PROJECTION
	▽=0	4 PLACES ± --- ± ---	mm	INCH	DRAWN BY AAB	DATE 05/12/93	TITLE SALES ASSY, SL VERTICAL HEADER W/LATCH&TRI-PEGS (2.54)/.100 CENTERS <b>molex</b>
	▽=0	3 PLACES ± --- ± .005			CHECKED BY MJM	DATE 05/12/93	
	▽=0	2 PLACES ± 0.13 ± .01			APPROVED BY SMILLER	DATE 2013/07/22	DOCUMENT NO. SDA-70545-****
	1 PLACE ± 0.25 ± ---	ANGULAR ±1/2°	SEE TABLE		SHEET NO. 3 OF 4		
	0 PLACE ± --- ± ---	DRAFT WHERE APPLICABLE MUST REMAIN WITHIN DIMENSIONS	THIS DRAWING CONTAINS INFORMATION THAT IS PROPRIETARY TO MOLEX INCORPORATED AND SHOULD NOT BE USED WITHOUT WRITTEN PERMISSION				

CIRCUIT SIZE	ASSEMBLY ITEM NUMBER 70545		D REF.	E ± .010	MATING AREA FINISH	PC TAIL AREA FINISH
2-19	-3001-3018	WEBBED ASSEMBLY	(3.30) .130	(6.10) .240	30 GOLD	TIN
20-25	-3019-3024	WEBBED ASSEMBLY	(3.30) .130	(6.10) .240	30 GOLD	TIN
2-19	-3051-3068	WEBBED ASSEMBLY	(3.30) .130	(6.10) .240	15 GOLD	TIN
20-25	-3069-3074	WEBBED ASSEMBLY	(3.30) .130	(6.10) .240	15 GOLD	TIN
2-19	-3101-3118	WEBBED ASSEMBLY	(3.30) .130	(6.10) .240	TIN	TIN
20-25	-3119-3124	WEBBED ASSEMBLY	(3.30) .130	(6.10) .240	TIN	TIN

CIRCUIT SIZE	WEBBED ASSEMBLY ITEM NUMBER	WEBBED ASSEMBLY ITEM NUMBER	WEBBED ASSEMBLY ITEM NUMBER
2			
3			
4			
5			
6			
7			
8			
9			
10			
11			
12			
13			
14			
15			
16			
17			
18			
19			
20	70545-3019	70545-3069	70545-3119
21	70545-3020	70545-3070	70545-3120
22	70545-3021	70545-3071	70545-3121
23	70545-3022	70545-3072	70545-3122
24	70545-3023	70545-3073	70545-3123
25	70545-3024	70545-3074	70545-3124

SEE SHEET 1 EC NO: UCP2017-1091 DRINKSMIEC 2016/11/11 CHKD: APPR:FSM/TH 2016/12/29 M	DESCRIPTION QUALITY SYMBOLS ▽=0 ▽=0 ▽=0	GENERAL TOLERANCES (UNLESS SPECIFIED)		DIMENSION STYLE MM/IN		SCALE	DESIGN UNITS INCH	THIRD ANGLE PROJECTION		
				mm	INCH	DRAWN BY AAB	DATE 05/12/93	TITLE SALES ASSY, SL VERTICAL HEADER W/LATCH&TRI-PEGS (2.54)/.100 CENTERS		
				4 PLACES ± ---	± ---	CHECKED BY MJM	DATE 05/12/93			
				2 PLACES ± 0.13	± .01	APPROVED BY SMILLER	DATE 2013/07/22	molex DOCUMENT NO. SDA-70545-**** SHEET NO. 4 OF 4		
		1 PLACE ± 0.25	± ---	DRAFT WHERE APPLICABLE MUST REMAIN WITHIN DIMENSIONS		THIS DRAWING CONTAINS INFORMATION THAT IS PROPRIETARY TO MOLEX INCORPORATED AND SHOULD NOT BE USED WITHOUT WRITTEN PERMISSION				



# OPTIONAL HOUSING

## WEBBED KEYING FEATURES

20 CKT HEADER  
SHOWN FOR REFERENCE

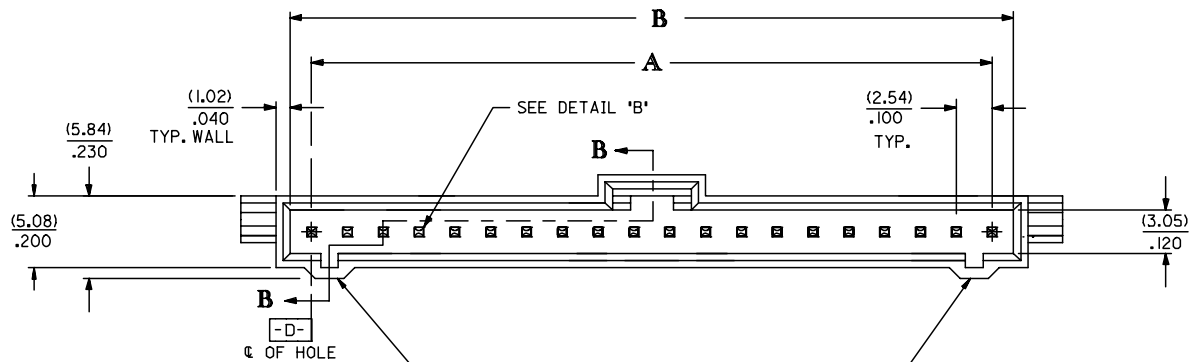
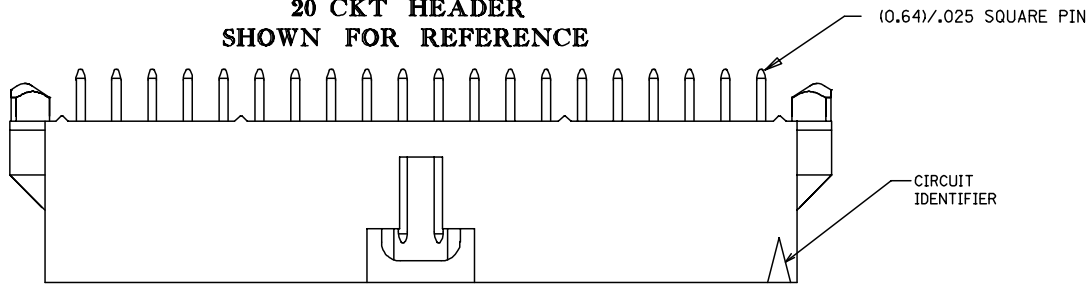

WEBBED KEYING FEATURES

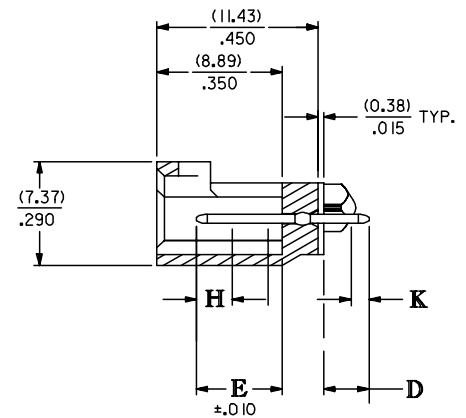

### SECTION B-B

UPDATE TITLE BLOCK EC NO: UCP2006-0202 DRAWN: JLOWE 2005/08/05 CHKD: ADERR 2005/08/05 APPR: FSMITH 2005/08/09 REVISION DESCRIPTION	QUALITY SYMBOLS	GENERAL TOLERANCES (UNLESS SPECIFIED)	DIMENSION STYLE	SCALE	DESIGN UNITS	THIRD ANGLE PROJECTION
	$\nabla=0$ $\nabla=0$	mm      INCH 4 PLACES ± --- ± --- 3 PLACES ± --- ± .005 2 PLACES ± 0.13 ± .01 1 PLACE ± 0.25 ± --- ANGULAR ± 1/2°	MM/IN	---	INCH	
		DRAFT WHERE APPLICABLE MUST REMAIN WITHIN DIMENSIONS	DRAWN BY DATE WGM 07/10/96 CHECKED BY DATE WGM 07/10/96 APPROVED BY DATE WAZ 07/10/96	TITLE	SALES ASSY, SL VERTICAL HEADER W/LATCH&TRI-PEGS (2.54)/.100 CENTERS	
			MATERIAL NO. SEE CHART SIZE C	DOCUMENT NO. SDA-70545-****	MOLEX INCORPORATED	

SHEET NO.  
2 OF 4

J	CIRCUIT SIZE	ASSEMBLY ITEM NUMBER 70545	MANUFACTURE RELEASE STATUS				D (± 0.38) ± .015	E (± 0.25) ± .010		CONNECTOR END PLATING			P.C. BOARD END PLATING		
										TYPE	H MEAS.		TYPE	K MEAS.	
I	2-10	-0001-0009	R.F.M.				(3.30)	(6.10)		TIN	(2.54) .100		TIN	(1.27) .050	
	11-25	-0010-0024	R.F.M.				.130	.240							
I	2-10	-0036-0044	R.F.M.				(3.30)	(6.10)		15 GOLD	(2.54) .100		TIN	(1.27) .050	
	11-25	-0045-0059	R.F.M.				.130	.240							
H	2-10	-0071-0079	R.F.M.				(3.30)	(6.10)		30 GOLD	(2.54) .100		TIN	(1.27) .050	
	11-25	-0080-0094	R.F.M.				.130	.240							
H	2-10	-0141-0149	R.F.M.				(5.21)	(6.10)		15 GOLD	(2.54) .100		TIN	(1.27) .050	
	11-25	-0150-0164	NOT TOOLED				.205	.240							
G	2-10	-0176-0184	R.F.M.				(5.21)	(6.10)		30 GOLD	(2.54) .100		TIN	(1.27) .050	
	11-25	-0185-0199	NOT TOOLED				.205	.240							

F	CIRCUIT SIZE	ASSEMBLY ITEM NUMBER	ASSEMBLY ITEM NUMBER	ASSEMBLY ITEM NUMBER	ASSEMBLY ITEM NUMBER	ASSEMBLY ITEM NUMBER
	2	70545-0001	70545-0036	70545-0071	70545-0141	70545-0176
	3	70545-0002	70545-0037	70545-0072	70545-0142	70545-0177
	4	70545-0003	70545-0038	70545-0073	70545-0143	70545-0178
	5	70545-0004	70545-0039	70545-0074	70545-0144	70545-0179
	6	70545-0005	70545-0040	70545-0075	70545-0145	70545-0180
	7	70545-0006	70545-0041	70545-0076	70545-0146	70545-0181
	8	70545-0007	70545-0042	70545-0077	70545-0147	70545-0182
E	9	70545-0008	70545-0043	70545-0078	70545-0148	70545-0183
	10	70545-0009	70545-0044	70545-0079	70545-0149	70545-0184
	11	70545-0010	70545-0045	70545-0080		
	12	70545-0011	70545-0046	70545-0081		
	13	70545-0012	70545-0047	70545-0082		
	14	70545-0013	70545-0048	70545-0083		
D	15	70545-0014	70545-0049	70545-0084		
	16	70545-0015	70545-0050	70545-0085		
	17	70545-0016	70545-0051	70545-0086		
	18	70545-0017	70545-0052	70545-0087		
	19	70545-0018	70545-0053	70545-0088		
	20	70545-0019	70545-0054	70545-0089		
C	21	70545-0020	70545-0055	70545-0090		
	22	70545-0021	70545-0056	70545-0091		
	23	70545-0022	70545-0057	70545-0092		
	24	70545-0023	70545-0058	70545-0093		
	25	70545-0024	70545-0059	70545-0094		

B	CHG D DIM -0141-0199 EC NO: UCP2007-0420 DRAWN: JORGAN 2006/09/15 CHKD: MS BARA 2006/09/15 APPR: SMILLER 2006/09/19	QUALITY SYMBOLS ▽=0 ▽=0	GENERAL TOLERANCES (UNLESS SPECIFIED) <table border="1"> <tr><th></th><th>mm</th><th>INCH</th></tr> <tr><td>4 PLACES</td><td>± .005</td><td>± .0005</td></tr> <tr><td>3 PLACES</td><td>± .01</td><td>± .001</td></tr> <tr><td>2 PLACES</td><td>± 0.13</td><td>± .01</td></tr> <tr><td>1 PLACE</td><td>± 0.25</td><td>± .01</td></tr> </table>		mm	INCH	4 PLACES	± .005	± .0005	3 PLACES	± .01	± .001	2 PLACES	± 0.13	± .01	1 PLACE	± 0.25	± .01	DIMENSION STYLE MM/IN DRAWN BY DATE WGM 07/12/96 CHECKED BY DATE WGM 07/12/96 APPROVED BY DATE DJB 07/12/96	SCALE --- DESIGN UNITS INCH THIRD ANGLE PROJECTION	TITLE SALES ASSY, SL VERTICAL HEADER W/LATCH&TRI-PEGS (2.54)/.100 CENTERS	MATERIAL NO. DOCUMENT NO. SDA-70545-****	SHEET NO. 3 OF 4
					mm	INCH																	
4 PLACES	± .005	± .0005																					
3 PLACES	± .01	± .001																					
2 PLACES	± 0.13	± .01																					
1 PLACE	± 0.25	± .01																					
DRAFT WHERE APPLICABLE MUST REMAIN WITHIN DIMENSIONS	SEE CHART																						

## X-ON Electronics

Largest Supplier of Electrical and Electronic Components

*Click to view similar products for [Headers & Wire Housings](#) category:*

*Click to view products by [Molex](#) manufacturer:*

Other Similar products are found below :

[892-18-020-10-001101](#) [58102-G61-06LF](#) [582553-1](#) [0009485154](#) [009176003701906](#) [0050291907](#) [LY20-4P-DT1-P1E-BR](#) [02.125.8002.8](#)  
[609-3404](#) [61062-3](#) [61082-181009](#) [622-3653LF](#) [63453-116](#) [636-1030](#) [636-1427](#) [636-3427](#) [636-4007](#) [641938-9](#) [641991-4](#) [644827-2](#) [65817-](#)  
[010LF](#) [65817-015LF](#) [65863-015LF](#) [66207-023LF](#) [67095-007LF](#) [67601157](#) [68648-049](#) [70.362.1628.0](#) [70-4210](#) [70-4226B](#) [70-4853B](#) [707-](#)  
[5020](#) [707-5028](#) [71.350.2428.0](#) [71918-208LF](#) [71961-016LF](#) [733-134](#) [733-162](#) [754199-000](#) [760-3052](#) [787-8014-00](#) [79531-3000](#) [FCN-](#)  
[360C032-B](#) [FCN-367T-T012/H](#) [FCN-723D010/2](#) [80.063.4001.1](#) [800-90-001-10-001000](#) [800-90-010-10-002000](#) [801-43-002-10-013000](#)  
[801-43-006-10-002000](#)