

OPTION A

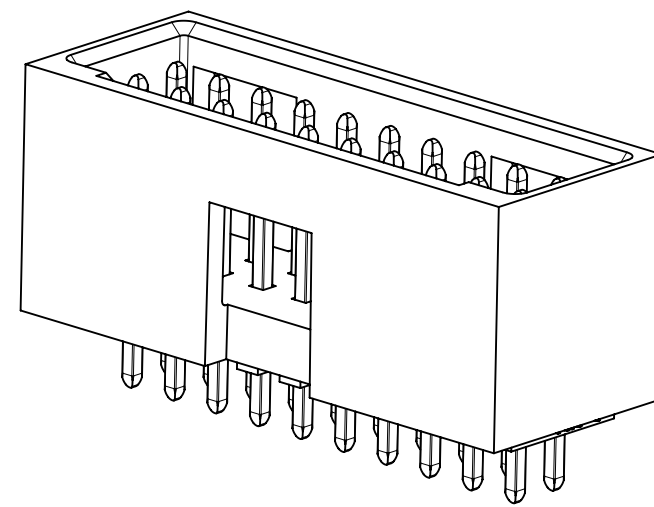
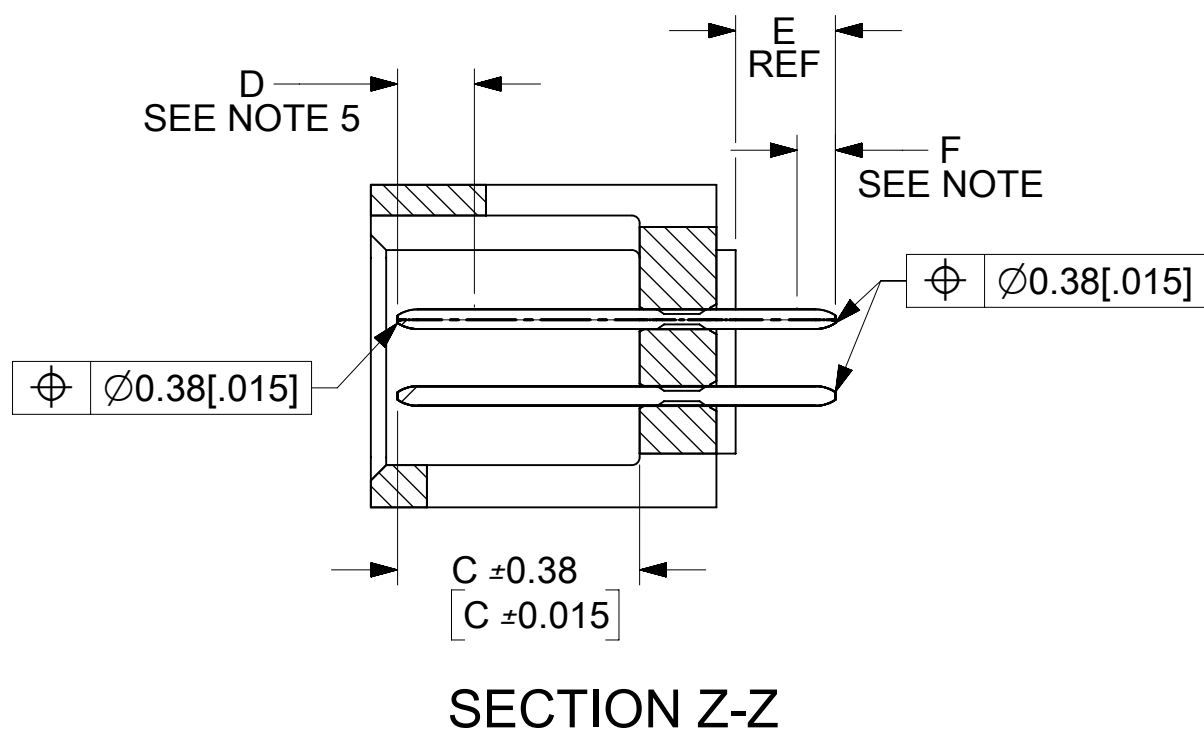
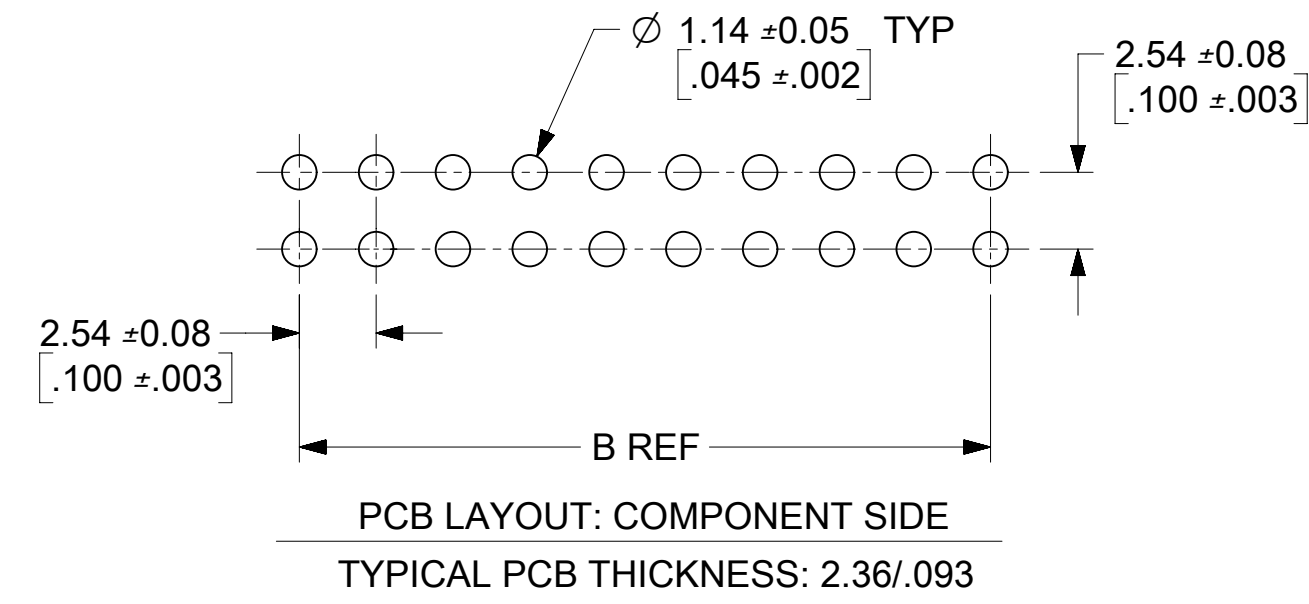
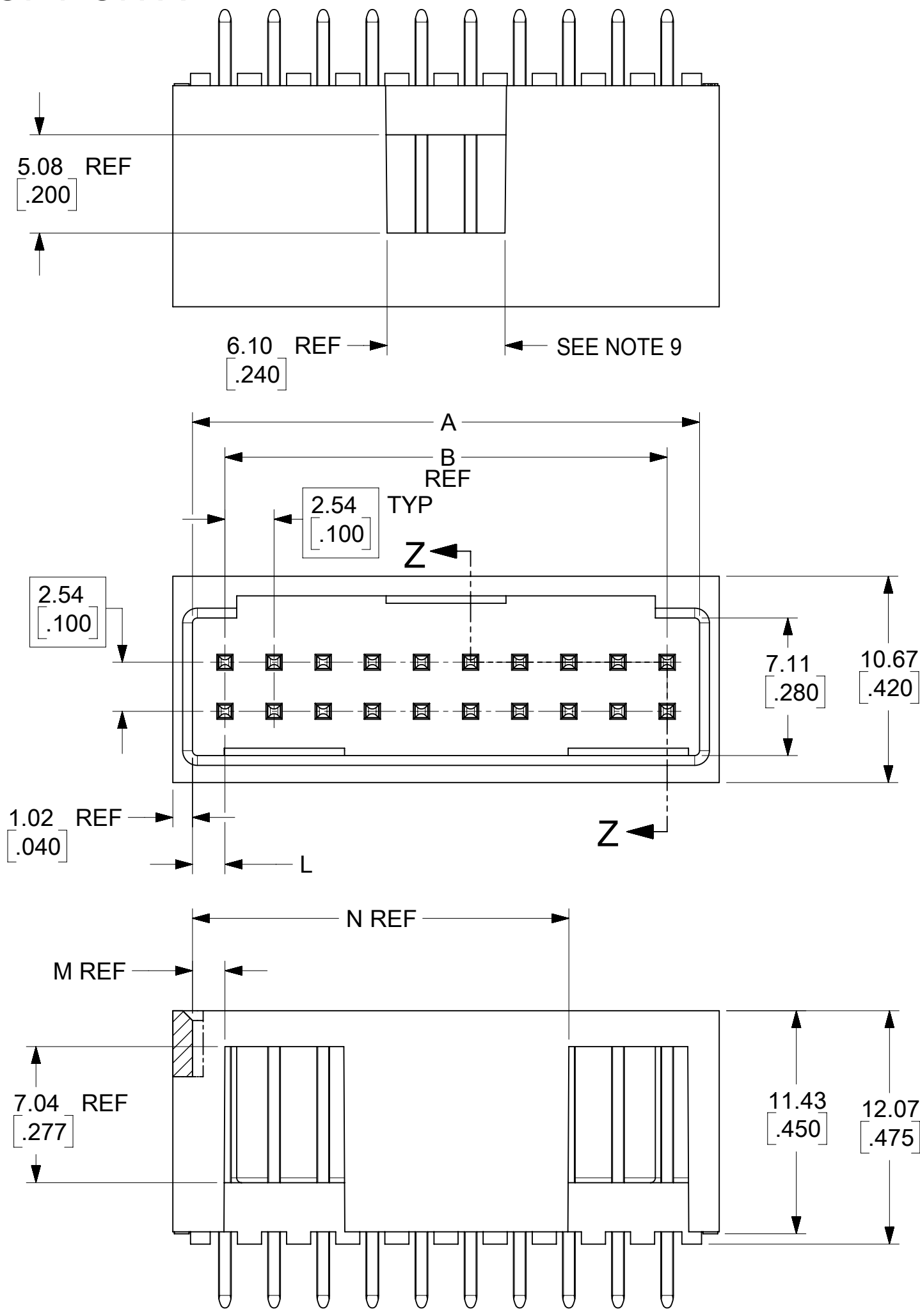

- NOTES:
- MATERIAL: GLASS FILLED, LIQUID CRYSTAL POLYMER, COLOR: BLACK, 94V-0. PINS: COPPER ALLOY.
 - PLATING:
 - TIN 150 MI MINIMUM TIN, OVER NICKEL UNDERPLATE OVERALL
 - 15 GOLD 15 MI MINIMUM GOLD PLATE IN SELECTED AREA
 - 75 MI MINIMUM TIN IN SELECTED AREA
 - OVER NICKEL UNDERPLATE OVERALL
 - 30 GOLD 30 MI MINIMUM GOLD PLATE IN SELECTED AREA
 - 75 MI MINIMUM TIN IN SELECTED AREA,
 - OVER NICKEL UNDERPLATE OVERALL
 - PRODUCT SPECIFICATION: PS-70567.
 - PACKAGING: SEE CHARTS
 - MEASURE POINT FOR PLATING THICKNESS.
 - PIN PUSHOUT FORCE: 4 LBS. MINIMUM IN DIRECTION INDICATED.
 - FOR ILLUSTRATION PURPOSES, 20 (DUAL 10) CIRCUIT SIZE HEADER SHOWN.
 - PIN SOLDERABILITY PER MOLEX SPEC. SMES-152.
 - WINDOW NOT AVAILABLE ON 6 OR 8 CIRCUIT SIZE.
 - COSMETIC SPECIFICATION PS-45499-002 CLASS B

CKT	DIM A	DIM B	DIM L	DIM M	DIM N
06	8.43 .332	5.08 .200	1.68 .066	1.68 .066	
08	10.97 .432	7.62 .300	1.68 .066	1.68 .066	
10	13.51 .532	10.16 .400	1.68 .066	4.22 .166	
12	16.05 .632	12.70 .500	1.68 .066	4.22 .166	
14	18.59 .732	15.24 .600	1.68 .066	6.76 .266	
16	21.13 .832	17.78 .700	1.68 .066	6.76 .266	
18	23.67 .932	20.32 .800	1.68 .066	9.30 .366	
20	26.21 1.032	22.86 .900	1.68 .066	1.68 .066	19.46 .766
22	28.75 1.132	25.40 1.000	1.68 .066	1.68 .066	22.00 .866
24	31.29 1.232	27.94 1.100	1.68 .066	1.68 .066	24.54 .966
26	33.83 1.332	30.48 1.200	1.68 .066	1.68 .066	27.08 1.066
28	36.37 1.432	33.02 1.300	1.68 .066	1.68 .066	29.62 1.166
30	38.91 1.532	35.56 1.400	1.68 .066	1.68 .066	32.16 1.266
32	41.45 1.632	38.10 1.500	1.68 .066	1.68 .066	34.70 1.366
34	43.99 1.732	40.64 1.600	1.68 .066	1.68 .066	37.24 1.466
36	46.53 1.832	43.18 1.700	1.68 .066	1.68 .066	39.78 1.566
38	49.07 1.932	45.72 1.800	1.68 .066	1.68 .066	42.32 1.666
40	51.61 2.032	48.26 1.900	1.68 .066	1.68 .066	44.86 1.766
42	54.15 2.132	50.80 2.000	1.68 .066	1.68 .066	47.40 1.866
44	56.69 2.232	53.34 2.100	1.68 .066	1.68 .066	49.94 1.966
46	59.23 2.332	55.88 2.200	1.68 .066	1.68 .066	52.48 2.066
48	61.77 2.432	58.42 2.300	1.68 .066	1.68 .066	55.02 2.166
50	64.31 2.532	60.96 2.400	1.68 .066	1.68 .066	57.56 2.266
52	66.85 2.632	63.50 2.500	1.68 .066	1.68 .066	60.10 2.366
54	69.39 2.732	66.04 2.600	1.68 .066	1.68 .066	62.64 2.466
56	71.93 2.832	68.58 2.700	1.68 .066	1.68 .066	65.18 2.566
58	74.47 2.932	71.12 2.800	1.68 .066	1.68 .066	67.72 2.666
60	77.01 3.032	73.66 2.900	1.68 .066	1.68 .066	70.26 2.766
62	79.55 3.132	76.20 3.000	1.68 .066	1.68 .066	72.80 2.866
64	82.09 3.232	78.74 3.100	1.68 .066	1.68 .066	75.34 2.966
66	84.63 3.332	81.28 3.200	1.68 .066	1.68 .066	77.88 3.066
68	87.17 3.432	83.82 3.300	1.68 .066	1.68 .066	80.42 3.166
70	89.71 3.532	86.36 3.400	1.68 .066	1.68 .066	82.96 3.266
72	92.25 3.632	88.90 3.500	1.68 .066	1.68 .066	85.50 3.366

SYMBOLS	THIS DRAWING CONTAINS INFORMATION THAT IS PROPRIETARY TO MOLEX ELECTRONIC TECHNOLOGIES, LLC AND SHOULD NOT BE USED WITHOUT WRITTEN PERMISSION			
	DIMENSION UNITS	SCALE		CURRENT REV DESC:
▽ = 0	MM	1:1		EC NO: 637057 DRWN: ABABUPS 2020/05/05 CHK'D: MRAMAKRISHNA 2020/05/06 APPR: MRAMAKRISHNA 2020/05/06
▽ = 0	GENERAL TOLERANCES (UNLESS SPECIFIED)			
▽ = 0		MM	INCH	INITIAL REVISION:
▽ = 0	4 PLACES	±	±	
▽ = 0	3 PLACES	±	± 0.005	DRWN: APPR:
▽ = 0	2 PLACES	± 0.13	± 0.01	
▽ = 0	1 PLACE	± 0.25	±	THIRD ANGLE PROJECTION
▽ = 0	0 PLACES	±	±	
▽ = 0		ANGULAR TOL ± 0.5°		DRAWING
▽ = 0	DRAFT WHERE APPLICABLE MUST REMAIN WITHIN DIMENSIONS			SERIES
				70567

molex

4 SIDES SHROUDED HEADER
HIGH TEMP, (2.54)/.100 GRID W/ (0.64)/.025 PINS

PRODUCT CUSTOMER DRAWING

DOCUMENT NUMBER: **SDA-70567-XXXX** | DOC TYPE: PSD | DOC PART: 001 | REVISION: K5

MATERIAL NUMBER: GENERAL MARKET | SHEET NUMBER: 1 OF 8

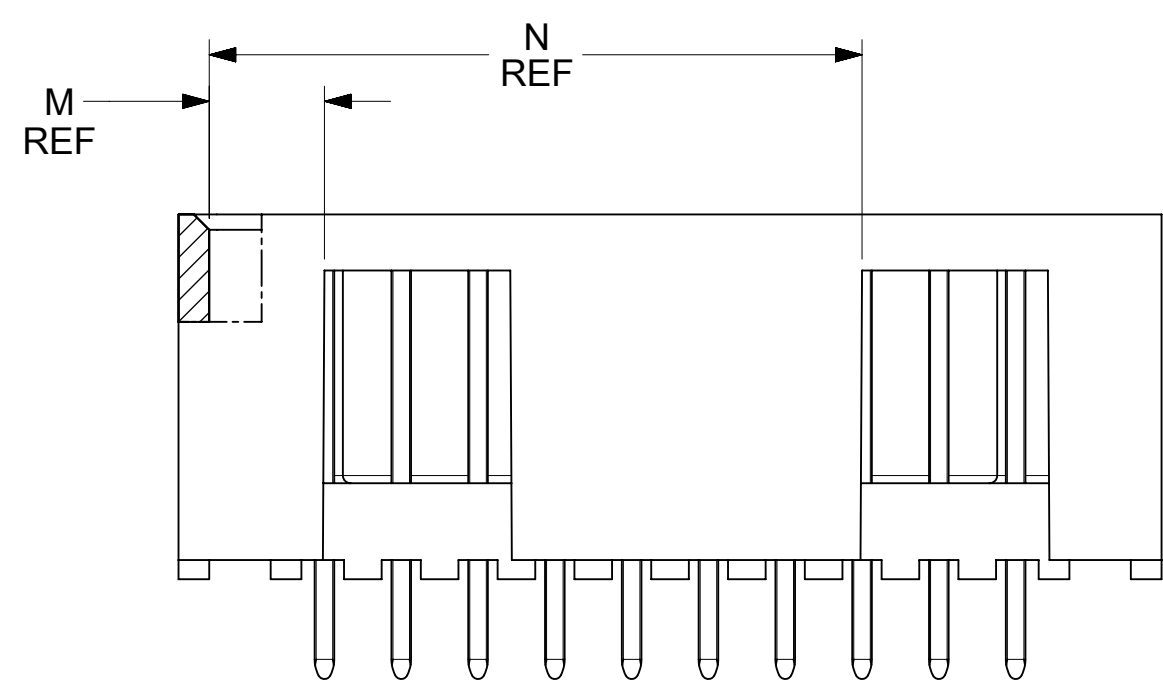
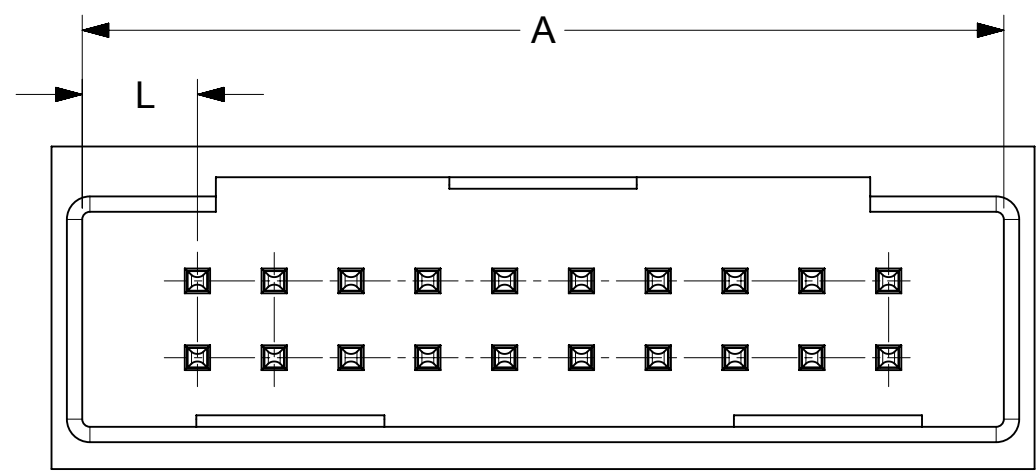
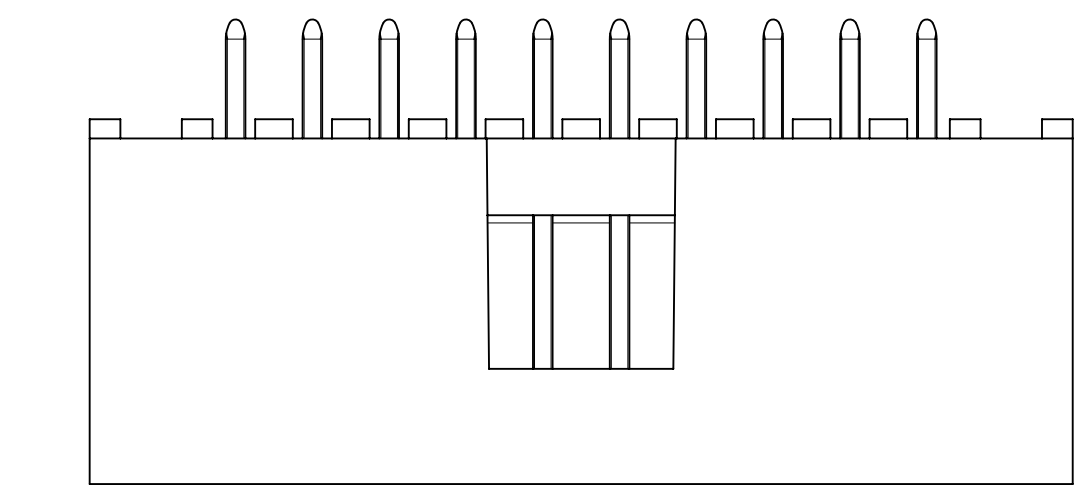
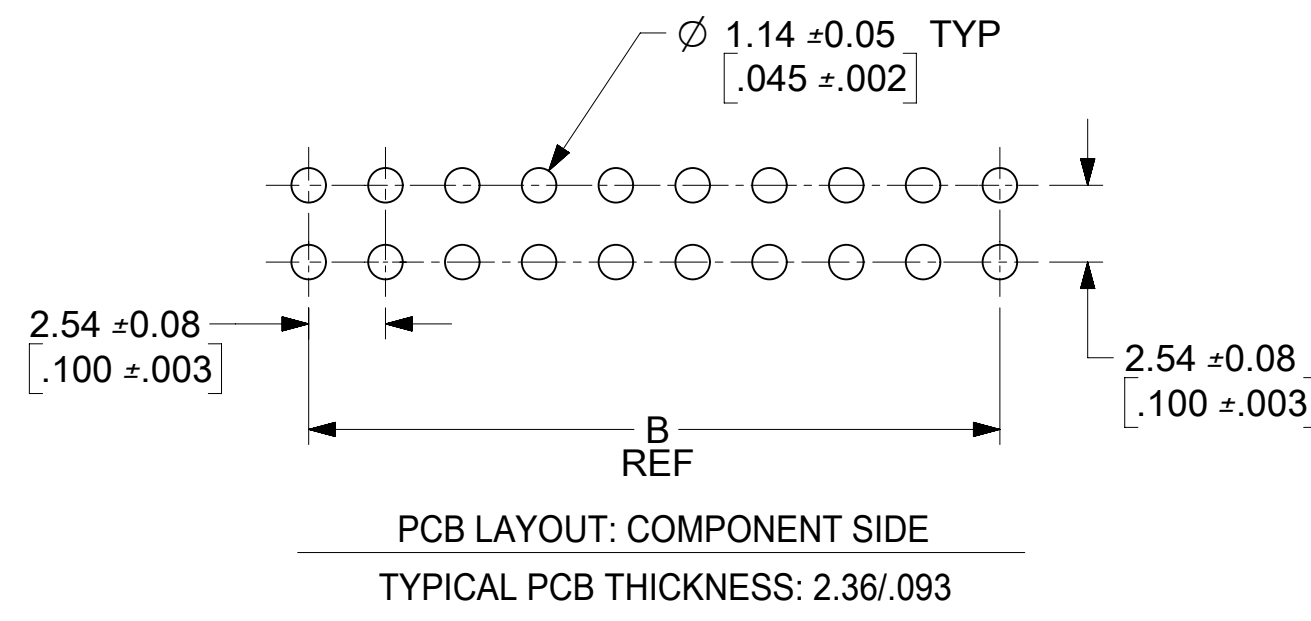

OPTION B
SAME AS OPTION A
EXCEPT AS SHOWN

CKT	DIM A	DIM B	DIM L	DIM M	DIM N
06	12.70	5.08	3.81	3.81	
	.500	.200	.150	.150	
08	15.24	7.62	3.81	3.81	
	.600	.300	.150	.150	
10	17.78	10.16	3.81	6.35	
	.700	.400	.150	.150	
12	20.32	12.70	3.81	6.35	
	.800	.500	.150	.150	
14	22.86	15.24	3.81	8.89	
	.900	.600	.150	.350	
16	25.40	17.78	3.81	8.89	
	1.000	.700	.150	.350	
18	27.94	20.32	3.81	11.43	
	1.100	.800	.150	.450	
20	30.48	22.86	3.81	3.81	21.59
	1.200	.900	.150	.150	.850
22	33.02	25.40	3.81	3.81	24.13
	1.300	1.000	.150	.150	.950
24	35.56	27.94	3.81	3.81	26.67
	1.400	1.100	.150	.150	1.050
26	38.10	30.48	3.81	3.81	29.21
	1.500	1.200	.150	.150	1.150
28	40.64	33.02	3.81	3.81	31.75
	1.600	1.300	.150	.150	1.250
30	43.18	35.56	3.81	3.81	34.29
	1.700	1.400	.150	.150	1.350
32	45.72	38.10	3.81	3.81	36.83
	1.800	1.500	.150	.150	1.450
34	48.26	40.64	3.81	3.81	39.37
	1.900	1.600	.150	.150	1.550
36	50.80	43.18	3.81	3.81	41.91
	2.000	1.700	.150	.150	1.650
38	53.34	45.72	3.81	3.81	44.45
	2.100	1.800	.150	.150	1.750
40	55.88	48.26	3.81	3.81	46.99
	2.200	1.900	.150	.150	1.850
42	58.42	50.80	3.81	3.81	49.53
	2.300	2.000	.150	.150	1.950
44	60.96	53.34	3.81	3.81	52.07
	2.400	2.100	.150	.150	2.050
46	63.50	55.88	3.81	3.81	54.61
	2.500	2.200	.150	.150	2.150
48	66.04	58.42	3.81	3.81	57.15
	2.600	2.300	.150	.150	2.250
50	68.58	60.96	3.81	3.81	59.69
	2.700	2.400	.150	.150	2.350
52	71.12	63.50	3.81	3.81	62.23
	2.800	2.500	.150	.150	2.450
54	73.66	66.04	3.81	3.81	64.77
	2.900	2.600	.150	.150	2.550
56	76.20	68.58	3.81	3.81	67.31
	3.000	2.700	.150	.150	2.650
58	78.74	71.12	3.81	3.81	69.85
	3.100	2.800	.150	.150	2.750
60	81.28	73.66	3.81	3.81	72.32
	3.200	2.900	.150	.150	2.850
62	83.82	76.20	3.81	3.81	74.93
	3.300	3.000	.150	.150	2.950
64	86.36	78.74	3.81	3.81	77.47
	3.400	3.100	.150	.150	3.050
66	88.90	81.28	3.81	3.81	80.01
	3.500	3.200	.150	.150	3.150
68	91.44	83.82	3.81	3.81	82.55
	3.600	3.300	.150	.150	3.250
70	93.98	86.36	3.81	3.81	85.09
	3.700	3.400	.150	.150	3.350
72	96.52	88.90	3.81	3.81	87.63
	3.800	3.500	.150	.150	3.450

SYMBOLS DIMENSION UNITS: MM, INCH SCALE: 1:1 CURRENT REV DESC: EC NO: 637057 DRWN: ABABUPS 2020/05/05 CHK'D: MRAMAKRISHNA 2020/05/06 APPR: MRAMAKRISHNA 2020/05/06 INITIAL REVISION: DRWN: APPR: THIRD ANGLE PROJECTION DRAWING: C-SIZE SERIES: 70567	THIS DRAWING CONTAINS INFORMATION THAT IS PROPRIETARY TO MOLEX ELECTRONIC TECHNOLOGIES, LLC AND SHOULD NOT BE USED WITHOUT WRITTEN PERMISSION		
	molex 4 SIDES SHROUDED HEADER HIGH TEMP, (2.54)/.100 GRID W/ (0.64)/.025 PINS		
	PRODUCT CUSTOMER DRAWING DOCUMENT NUMBER: SDA-70567-XXXX DOC TYPE: PSD DOC PART: 001 REVISION: K5		
	MATERIAL NUMBER: GENERAL MARKET SHEET NUMBER: 2 OF 8		
	DRAFT WHERE APPLICABLE MUST REMAIN WITHIN DIMENSIONS		
	DRAFT WHERE APPLICABLE MUST REMAIN WITHIN DIMENSIONS		
	DRAFT WHERE APPLICABLE MUST REMAIN WITHIN DIMENSIONS		
	DRAFT WHERE APPLICABLE MUST REMAIN WITHIN DIMENSIONS		
	DRAFT WHERE APPLICABLE MUST REMAIN WITHIN DIMENSIONS		
	DRAFT WHERE APPLICABLE MUST REMAIN WITHIN DIMENSIONS		

OPTION C

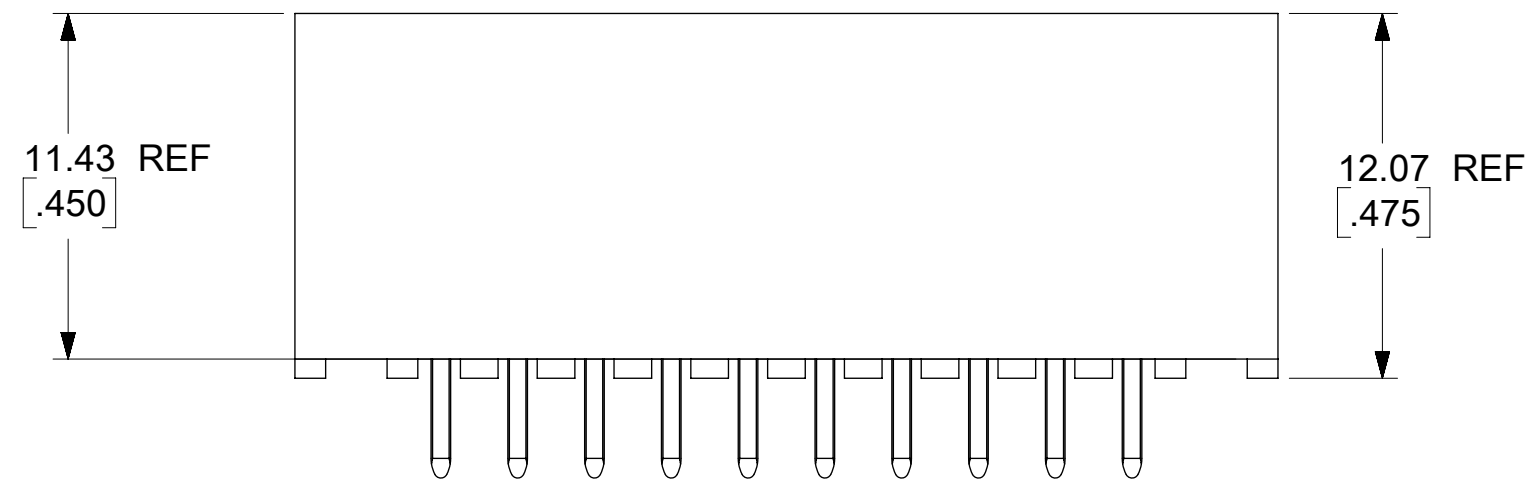
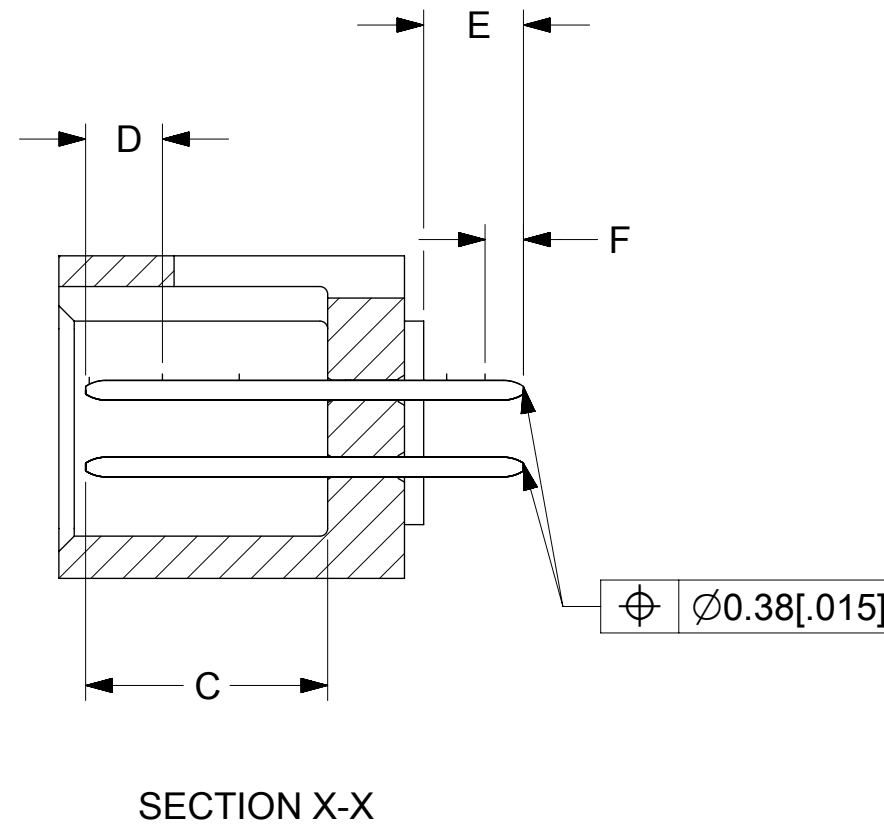
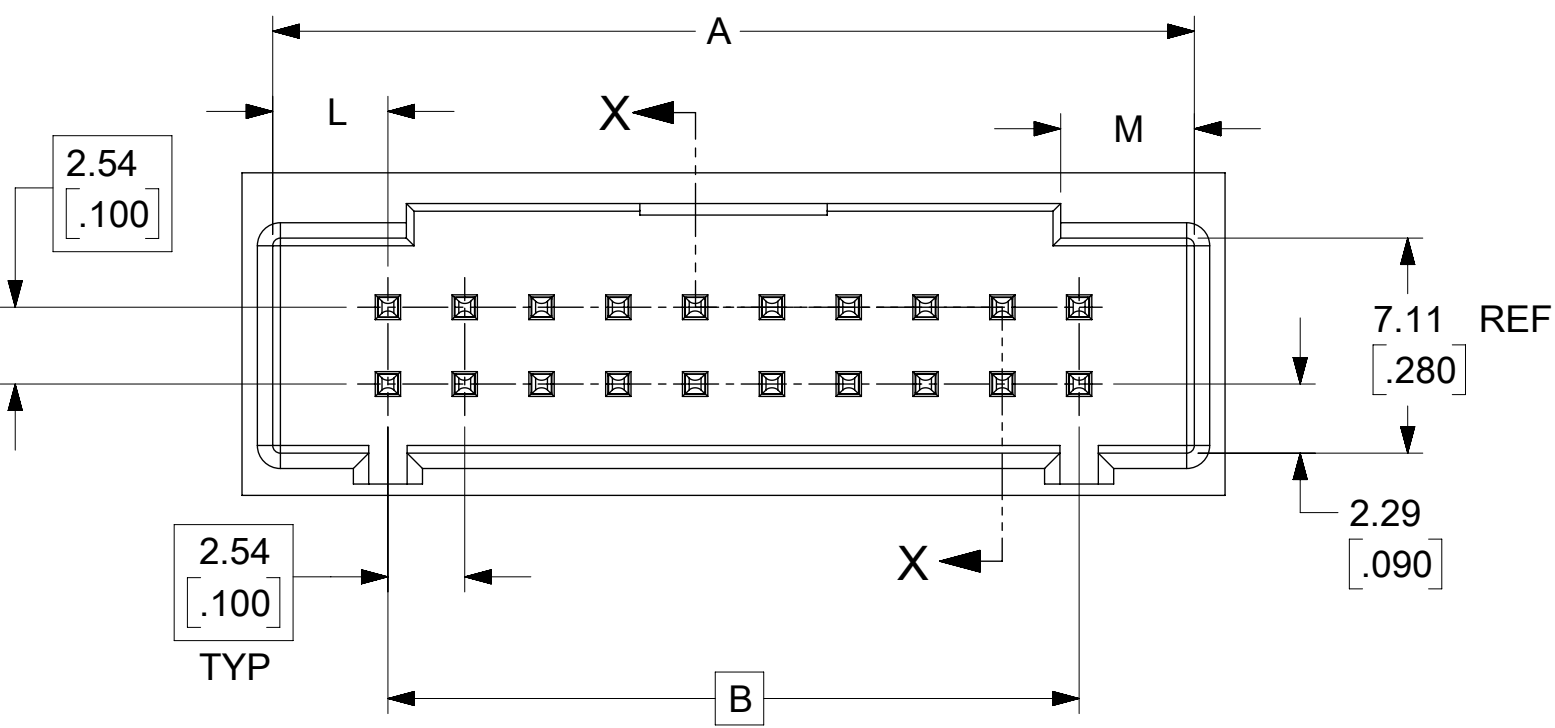
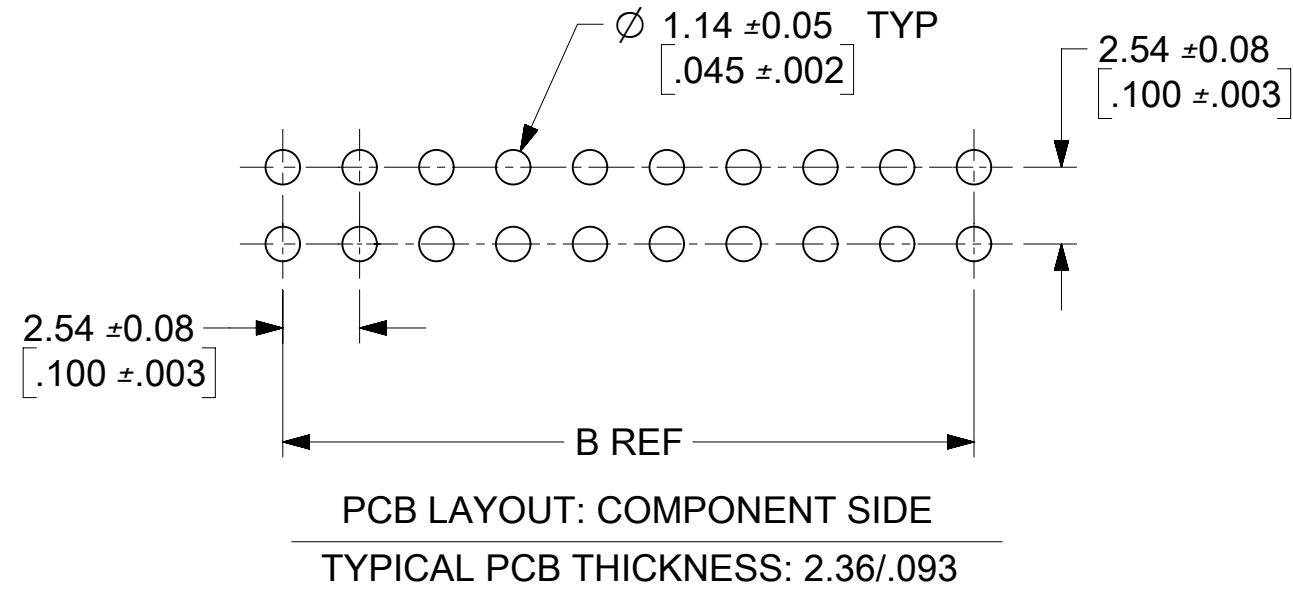
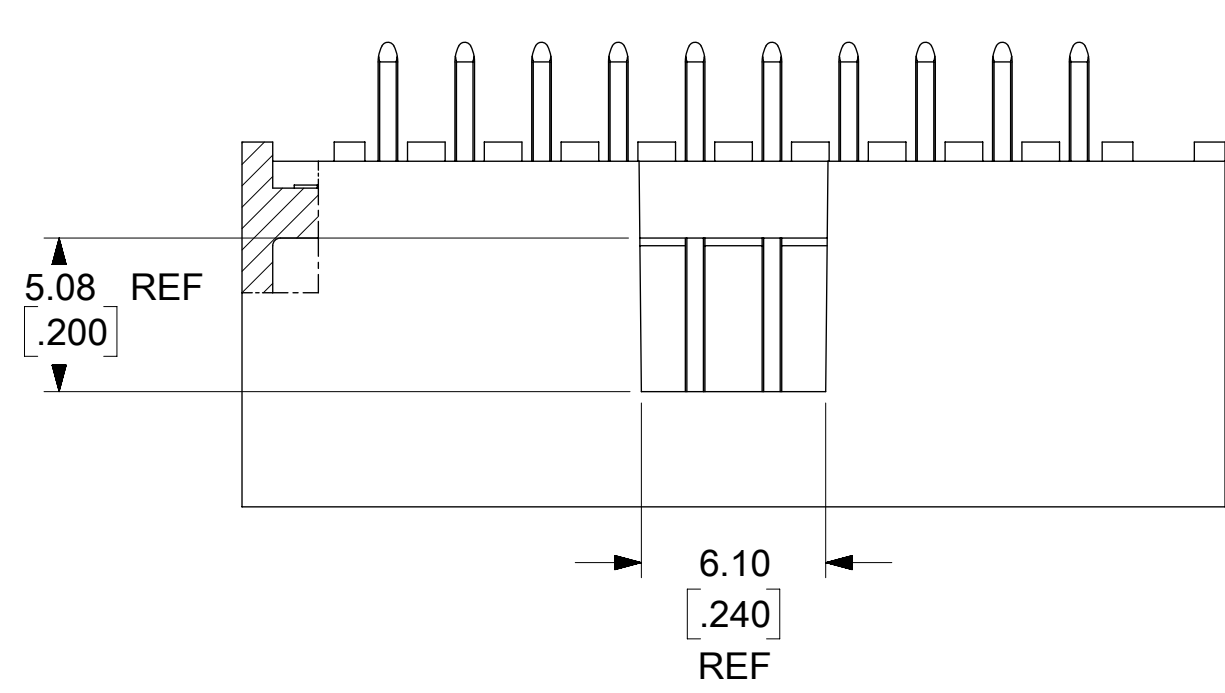

CKT	DIM A	DIM B	DIM L	DIM M
06	12.70 .500	5.08 .200	3.81 .150	3.18 .125
08	15.24 .600	7.62 .300	3.81 .150	4.42 .174
10	17.78 .700	10.16 .400	3.81 .150	4.42 .174
12	20.32 .800	12.70 .500	3.81 .150	4.42 .174
14	22.86 .900	15.24 .600	3.81 .150	4.42 .174
16	25.40 1.000	17.78 .700	3.81 .150	4.42 .174
18	27.94 1.100	20.32 .800	3.81 .150	4.42 .174
20	30.48 1.200	22.86 .900	3.81 .150	4.42 .174
22	33.02 1.300	25.40 1.000	3.81 .150	4.42 .174
24	35.56 1.400	27.94 1.100	3.81 .150	4.42 .174
26	38.10 1.500	30.48 1.200	3.81 .150	4.42 .174
28	40.64 1.600	33.02 1.300	3.81 .150	4.42 .174
30	43.18 1.700	35.56 1.400	3.81 .150	4.42 .174
32	45.72 1.800	38.10 1.500	3.81 .150	4.42 .174
34	48.26 1.900	40.64 1.600	3.81 .150	4.42 .174
36	50.80 2.000	43.18 1.700	3.81 .150	4.42 .174
38	53.34 2.100	45.72 1.800	3.81 .150	4.42 .174
40	55.88 2.200	48.26 1.900	3.81 .150	4.42 .174
42	58.42 2.300	50.80 2.000	3.81 .150	4.42 .174
44	60.96 2.400	53.34 2.100	3.81 .150	4.42 .174
46	63.50 2.500	55.88 2.200	3.81 .150	4.42 .174
48	66.04 2.600	58.42 2.300	3.81 .150	4.42 .174
50	68.58 2.700	60.96 2.400	3.81 .150	4.42 .174
52	71.12 2.800	63.50 2.500	3.81 .150	4.42 .174
54	73.66 2.900	66.04 2.600	3.81 .150	4.42 .174
56	76.20 3.000	68.58 2.700	3.81 .150	4.42 .174
58	78.74 3.100	71.12 2.800	3.81 .150	4.42 .174
60	81.28 3.200	73.66 2.900	3.81 .150	4.42 .174
62	83.82 3.300	76.20 3.000	3.81 .150	4.42 .174
64	86.36 3.400	78.74 3.100	3.81 .150	4.42 .174
66	88.90 3.500	81.28 3.200	3.81 .150	4.42 .174
68	91.44 3.600	83.82 3.300	3.81 .150	4.42 .174
70	93.98 3.700	86.36 3.400	3.81 .150	4.42 .174
72	96.52 3.800	88.90 3.500	3.81 .150	4.42 .174

SYMBOLS DIMENSION UNITS: MM, INCH SCALE: 4:1 CURRENT REV DESC: EC NO: 637057 DRWN: ABABUPS 2020/05/05 CHK'D: MRAMAKRISHNA 2020/05/06 APPR: MRAMAKRISHNA 2020/05/06 INITIAL REVISION: DRWN: APPR: THIRD ANGLE PROJECTION DRAWING: C-SIZE SERIES: 70567	THIS DRAWING CONTAINS INFORMATION THAT IS PROPRIETARY TO MOLEX ELECTRONIC TECHNOLOGIES, LLC AND SHOULD NOT BE USED WITHOUT WRITTEN PERMISSION				
	GENERAL TOLERANCES (UNLESS SPECIFIED) 4 PLACES ± .01 3 PLACES ± .005 2 PLACES ± 0.13 ± 0.01 1 PLACE ± 0.25 ± 0 PLACES ± ANGULAR TOL ± 0.5 °				4 SIDES SHROUDED HEADER HIGH TEMP, (2.54)/.100 GRID W/ (0.64)/.025 PINS
	DRAFT WHERE APPLICABLE MUST REMAIN WITHIN DIMENSIONS		PRODUCT CUSTOMER DRAWING		
	DOCUMENT NUMBER: SDA-70567-XXXX		DOC TYPE: PSD	DOC PART: 001	REVISION: K5
	MATERIAL NUMBER: GENERAL MARKET		SHEET NUMBER: 3 OF 8		

NO. OF CKTS	OPTION "A"		OPTION "A"		OPTION "A"		OPTION "A"		OPTION "A"		OPTION "A"	
	EDP NUMBER	ENG NUMBER	EDP NUMBER	ENG NUMBER	EDP NUMBER	ENG NUMBER	EDP NUMBER	ENG NUMBER	EDP NUMBER	ENG NUMBER	EDP NUMBER	ENG NUMBER
06	15-80-0061	A-70567-0001	70567-0035	A-70567-0035	15-80-0063	A-70567-0069	70567-0103	A-70567-0103	15-80-0065	A-70567-0137	70567-0171	A-70567-0171
08	15-80-0081	A-70567-0002	70567-0036	A-70567-0036	15-80-0083	A-70567-0070	70567-0104	A-70567-0104	15-80-0085	A-70567-0138	70567-0172	A-70567-0172
10	15-80-0101	A-70567-0003	70567-0037	A-70567-0037	15-80-0103	A-70567-0071	70567-0105	A-70567-0105	15-80-0105	A-70567-0139	70567-0173	A-70567-0173
12	15-80-0121	A-70567-0004	70567-0038	A-70567-0038	15-80-0123	A-70567-0072	70567-0106	A-70567-0106	15-80-0125	A-70567-0140	70567-0174	A-70567-0174
14	15-80-0141	A-70567-0005	70567-0039	A-70567-0039	15-80-0143	A-70567-0073	70567-0107	A-70567-0107	15-80-0145	A-70567-0141	70567-0175	A-70567-0175
16	15-80-0161	A-70567-0006	70567-0040	A-70567-0040	15-80-0163	A-70567-0074	70567-0108	A-70567-0108	15-80-0165	A-70567-0142	70567-0176	A-70567-0176
18	15-80-0181	A-70567-0007	70567-0041	A-70567-0041	15-80-0183	A-70567-0075	70567-0109	A-70567-0109	15-80-0185	A-70567-0143	70567-0177	A-70567-0177
20	15-80-0201	A-70567-0008	70567-0042	A-70567-0042	15-80-0203	A-70567-0076	70567-0110	A-70567-0110	15-80-0205	A-70567-0144	70567-0178	A-70567-0178
22	15-80-0221	A-70567-0009	70567-0043	A-70567-0043	15-80-0223	A-70567-0077	70567-0111	A-70567-0111	15-80-0225	A-70567-0145	70567-0179	A-70567-0179
24	15-80-0241	A-70567-0010	70567-0044	A-70567-0044	15-80-0243	A-70567-0078	70567-0112	A-70567-0112	15-80-0245	A-70567-0146	70567-0180	A-70567-0180
26	15-80-0261	A-70567-0011	70567-0045	A-70567-0045	15-80-0263	A-70567-0079	70567-0113	A-70567-0113	15-80-0265	A-70567-0147	70567-0181	A-70567-0181
28	15-80-0281	A-70567-0012	70567-0046	A-70567-0046	15-80-0283	A-70567-0080	70567-0114	A-70567-0114	15-80-0285	A-70567-0148	70567-0182	A-70567-0182
30	15-80-0301	A-70567-0013	70567-0047	A-70567-0047	15-80-0303	A-70567-0081	70567-0115	A-70567-0115	15-80-0305	A-70567-0149	70567-0183	A-70567-0183
32	15-80-0321	A-70567-0014	70567-0048	A-70567-0048	15-80-0323	A-70567-0082	70567-0116	A-70567-0116	15-80-0325	A-70567-0150	70567-0184	A-70567-0184
34	15-80-0341	A-70567-0015	70567-0049	A-70567-0049	15-80-0343	A-70567-0083	70567-0117	A-70567-0117	15-80-0345	A-70567-0151	70567-0185	A-70567-0185
36	15-80-0361	A-70567-0016	70567-0050	A-70567-0050	15-80-0363	A-70567-0084	70567-0118	A-70567-0118	15-80-0365	A-70567-0152	70567-0186	A-70567-0186
38	15-80-0381	A-70567-0017	70567-0051	A-70567-0051	15-80-0383	A-70567-0085	70567-0119	A-70567-0119	15-80-0385	A-70567-0153	70567-0187	A-70567-0187
40	15-80-0401	A-70567-0018	70567-0052	A-70567-0052	15-80-0403	A-70567-0086	70567-0120	A-70567-0120	15-80-0405	A-70567-0154	70567-0188	A-70567-0188
42	15-80-0421	A-70567-0019	70567-0053	A-70567-0053	15-80-0423	A-70567-0087	70567-0121	A-70567-0121	15-80-0425	A-70567-0155	70567-0189	A-70567-0189
44	15-80-0441	A-70567-0020	70567-0054	A-70567-0054	15-80-0443	A-70567-0088	70567-0122	A-70567-0122	15-80-0445	A-70567-0156	70567-0190	A-70567-0190
46	15-80-0461	A-70567-0021	70567-0055	A-70567-0055	15-80-0463	A-70567-0089	70567-0123	A-70567-0123	15-80-0465	A-70567-0157	70567-0191	A-70567-0191
48	15-80-0481	A-70567-0022	70567-0056	A-70567-0056	15-80-0483	A-70567-0090	70567-0124	A-70567-0124	15-80-0485	A-70567-0158	70567-0192	A-70567-0192
50	15-80-0501	A-70567-0023	70567-0057	A-70567-0057	15-80-0503	A-70567-0091	70567-0125	A-70567-0125	15-80-0505	A-70567-0159	70567-0193	A-70567-0193
52	15-80-0521	A-70567-0024	70567-0058	A-70567-0058	15-80-0523	A-70567-0092	70567-0126	A-70567-0126	15-80-0525	A-70567-0160	70567-0194	A-70567-0194
54	15-80-0541	A-70567-0025	70567-0059	A-70567-0059	15-80-0543	A-70567-0093	70567-0127	A-70567-0127	15-80-0545	A-70567-0161	70567-0195	A-70567-0195
56	15-80-0561	A-70567-0026	70567-0060	A-70567-0060	15-80-0563	A-70567-0094	70567-0128	A-70567-0128	15-80-0565	A-70567-0162	70567-0196	A-70567-0196
58	15-80-0581	A-70567-0027	70567-0061	A-70567-0061	15-80-0583	A-70567-0095	70567-0129	A-70567-0129	15-80-0585	A-70567-0163	70567-0197	A-70567-0197
60	15-80-0601	A-70567-0028	70567-0062	A-70567-0062	15-80-0603	A-70567-0096	70567-0130	A-70567-0130	15-80-0605	A-70567-0164	70567-0198	A-70567-0198
62	15-80-0621	A-70567-0029	70567-0063	A-70567-0063	15-80-0623	A-70567-0097	70567-0131	A-70567-0131	15-80-0625	A-70567-0165	70567-0199	A-70567-0199
64	15-80-0641	A-70567-0030	70567-0064	A-70567-0064	15-80-0643	A-70567-0098	70567-0132	A-70567-0132	15-80-0645	A-70567-0166	70567-0200	A-70567-0200
66	15-80-0661	A-70567-0031	70567-0065	A-70567-0065	15-80-0663	A-70567-0099	70567-0133	A-70567-0133	15-80-0665	A-70567-0167	70567-0201	A-70567-0201
68	15-80-0681	A-70567-0032	70567-0066	A-70567-0066	15-80-0683	A-70567-0100	70567-0134	A-70567-0134	15-80-0685	A-70567-0168	70567-0202	A-70567-0202
70	15-80-0701	A-70567-0033	70567-0067	A-70567-0067	15-80-0703	A-70567-0101	70567-0135	A-70567-0135	15-80-0705	A-70567-0169	70567-0203	A-70567-0203
72	15-80-0721	A-70567-0034	70567-0068	A-70567-0068	15-80-0723	A-70567-0102	70567-0136	A-70567-0136	15-80-0725	A-70567-0170	70567-0204	A-70567-0204

SYMBOL	
	= C
	= C
	= C
	= C
	= C
	= C
	= C
	= C
	= C

NO. OF CKTS	OPTION "B"		OPTION "B"		OPTION "B"		OPTION "B"		OPTION "B"		OPTION "B"	
	EDP NUMBER	ENG NUMBER	EDP NUMBER	ENG NUMBER	EDP NUMBER	ENG NUMBER	EDP NUMBER	ENG NUMBER	EDP NUMBER	ENG NUMBER	EDP NUMBER	ENG NUMBER
06	15-80-0067	A-70567-0205	70567-0239	A-70567-0239	15-80-0069	A-70567-0273	70567-0307	A-70567-0307	15-80-1061	A-70567-0341	70567-0375	A-70567-0375
08	15-80-0087	A-70567-0206	70567-0240	A-70567-0240	15-80-0089	A-70567-0274	70567-0308	A-70567-0308	15-80-1081	A-70567-0342	70567-0376	A-70567-0376
10	15-80-0107	A-70567-0207	70567-0241	A-70567-0241	15-80-0109	A-70567-0275	70567-0309	A-70567-0309	15-80-1101	A-70567-0343	70567-0377	A-70567-0377
12	15-80-0127	A-70567-0208	70567-0242	A-70567-0242	15-80-0129	A-70567-0276	70567-0310	A-70567-0310	15-80-1121	A-70567-0344	70567-0378	A-70567-0378
14	15-80-0147	A-70567-0209	70567-0243	A-70567-0243	15-80-0149	A-70567-0277	70567-0311	A-70567-0311	15-80-1141	A-70567-0345	70567-0379	A-70567-0379
16	15-80-0167	A-70567-0210	70567-0244	A-70567-0244	15-80-0169	A-70567-0278	70567-0312	A-70567-0312	15-80-1161	A-70567-0346	70567-0380	A-70567-0380
18	15-80-0187	A-70567-0211	70567-0245	A-70567-0245	15-80-0189	A-70567-0279	70567-0313	A-70567-0313	15-80-1181	A-70567-0347	70567-0381	A-70567-0381
20	15-80-0207	A-70567-0212	70567-0246	A-70567-0246	15-80-0209	A-70567-0280	70567-0314	A-70567-0314	15-80-1201	A-70567-0348	70567-0382	A-70567-0382
22	15-80-0227	A-70567-0213	70567-0247	A-70567-0247	15-80-0229	A-70567-0281	70567-0315	A-70567-0315	15-80-1221	A-70567-0349	70567-0383	A-70567-0383
24	15-80-0247	A-70567-0214	70567-0248	A-70567-0248	15-80-0249	A-70567-0282	70567-0316	A-70567-0316	15-80-1241	A-70567-0350	70567-0384	A-70567-0384
26	15-80-0267	A-70567-0215	70567-0249	A-70567-0249	15-80-0269	A-70567-0283	70567-0317	A-70567-0317	15-80-1261	A-70567-0351	70567-0385	A-70567-0385
28	15-80-0287	A-70567-0216	70567-0250	A-70567-0250	15-80-0289	A-70567-0284	70567-0318	A-70567-0318	15-80-1281	A-70567-0352	70567-0386	A-70567-0386
30	15-80-0307	A-70567-0217	70567-0251	A-70567-0251	15-80-0309	A-70567-0285	70567-0319	A-70567-0319	15-80-1301	A-70567-0353	70567-0387	A-70567-0387
32	15-80-0327	A-70567-0218	70567-0252	A-70567-0252	15-80-0329	A-70567-0286	70567-0320	A-70567-0320	15-80-1321	A-70567-0354	70567-0388	A-70567-0388
34	15-80-0347	A-70567-0219	70567-0253	A-70567-0253	15-80-0349	A-70567-0287	70567-0321	A-70567-0321	15-80-1341	A-70567-0355	70567-0389	A-70567-0389
36	15-80-0367	A-70567-0220	70567-0254	A-70567-0254	15-80-0369	A-70567-0288	70567-0322	A-70567-0322	15-80-1361	A-70567-0356	70567-0390	A-70567-0390
38	15-80-0387	A-70567-0221	70567-0255	A-70567-0255	15-80-0389	A-70567-0289	70567-0323	A-70567-0323	15-80-1381	A-70567-0357	70567-0391	A-70567-0391
40	15-80-0407	A-70567-0222	70567-0256	A-70567-0256	15-80-0409	A-70567-0290	70567-0324	A-70567-0324	15-80-1401	A-70567-0358	70567-0392	A-70567-0392
42	15-80-0427	A-70567-0223	70567-0257	A-70567-0257	15-80-0429	A-70567-0291	70567-0325	A-70567-0325	15-80-1421	A-70567-0359	70567-0393	A-70567-0393
44	15-80-0447	A-70567-0224	70567-0258	A-70567-0258	15-80-0449	A-70567-0292	70567-0326	A-70567-0326	15-80-1441	A-70567-0360	70567-0394	A-70567-0394
46	15-80-0467	A-70567-0225	70567-0259	A-70567-0259	15-80-0469	A-70567-0293	70567-0327	A-70567-0327	15-80-1461	A-70567-0361	70567-0395	A-70567-0395
48	15-80-0487	A-70567-0226	70567-0260	A-70567-0260	15-80-0489	A-70567-0294	70567-0328	A-70567-0328	15-80-1481	A-70567-0362	70567-0396	A-70567-0396
50	15-80-0507	A-70567-0227	70567-0261	A-70567-0261	15-80-0509	A-70567-0295	70567-0329	A-70567-0329	15-80-1501	A-70567-0363	70567-0397	A-70567-0397
52	15-80-0527	A-70567-0228	70567-0262	A-70567-0262	15-80-0529	A-70567-0296	70567-0330	A-70567-0330	15-80-1521	A-70567-0364	70567-0398	A-70567-0398
54	15-80-0547	A-70567-0229	70567-0263	A-70567-0263	15-80-0549	A-70567-0297	70567-0331	A-70567-0331	15-80-1541	A-70567-0365	70567-0399	A-70567-0399
56	15-80-0567	A-70567-0230	70567-0264	A-70567-0264	15-80-0569	A-70567-0298	70567-0332	A-70567-0332	15-80-1561	A-70567-0366	70567-0400	A-70567-0400
58	15-80-0587	A-70567-0231	70567-0265	A-70567-0265	15-80-0589	A-70567-0299	70567-0333	A-70567-0333	15-80-1581	A-70567-0367	70567-0401	A-70567-0401
60	15-80-0607	A-70567-0232	70567-0266	A-70567-0266	15-80-0609	A-70567-0300	70567-0334	A-70567-0334	15-80-1601	A-70567-0368	70567-0402	A-70567-0402
62	15-80-0627	A-70567-0233	70567-0267	A-70567-0267	15-80-0629	A-70567-0301	70567-0335	A-70567-0335	15-80-1621	A-70567-0369	70567-0403	A-70567-0403
64	15-80-0647	A-70567-0234	70567-0268	A-70567-0268	15-80-0649	A-70567-0302	70567-0336	A-70567-0336	15-80-1641	A-70567-0370	70567-0404	A-70567-0404
66	15-80-0667	A-70567-0235	70567-0269	A-70567-0269	15-80-0669	A-70567-0303	70567-0337	A-70567-0337	15-80-1661	A-70567-0371	70567-0405	A-70567-0405
68	15-80-0687	A-70567-0236	70567-0270	A-70567-0270	15-80-0689	A-70567-0304	70567-0338	A-70567-0338	15-80-1681	A-70567-0372	70567-0406	A-70567-0406
70	15-80-0707	A-70567-0237	70567-0271	A-70567-0271	15-80-0709	A-70567-0305	70567-0339	A-70567-0339	15-80-1701	A-70567-0373	70567-0407	A-70567-0407
72	15-80-0727	A-70567-0238	70567-0272	A-70567-0272	15-80-0729	A-70567-0306	70567-0340	A-70567-0340	15-80-1721	A-70567-0374	70567-0408	A-70567-0408

SYMBOL	
	= C
	= C
	= C
	= C
	= C
	= C
	= C
	= C
	= C

DOCUMENT STATUS P1 RELEASE DATE 2020/05/06 14:13:05

-0545/-0578	R.F.M					.130 (3.30)	.315 (8.00)				GOLD		.100 (2.54)	TIN	
-0579/-0612	R.F.M					.200 (5.08)	.315 (8.00)				GOLD		.100 (2.54)	TIN	

NO. OF CKTS	OPTION "C"		OPTION "C"		OPTION "C"		OPTION "C"		OPTION "C"		OPTION "C"		EDP NUMBER
	EDP NUMBER	ENG NUMBER	EDP NUMBER	ENG NUMBER	EDP NUMBER	ENG NUMBER	EDP NUMBER	ENG NUMBER	EDP NUMBER	ENG NUMBER	EDP NUMBER	ENG NUMBER	
06	15-80-1062	A-70567-0409		AX-70567-0443	15-80-1063	A-70567-0477		AX-70567-0511	15-80-1064	A-70567-0545		AX-70567-0579	
08	15-80-1082	A-70567-0410		AX-70567-0444	15-80-1083	A-70567-0478		AX-70567-0512	15-80-1084	A-70567-0546		AX-70567-0580	
10	15-80-1102	A-70567-0411		AX-70567-0445	15-80-1103	A-70567-0479		AX-70567-0513	15-80-1104	A-70567-0547		AX-70567-0581	
12	15-80-1122	A-70567-0412		AX-70567-0446	15-80-1123	A-70567-0480		AX-70567-0514	15-80-1124	A-70567-0548		AX-70567-0582	
14	15-80-1142	A-70567-0413		AX-70567-0447	15-80-1143	A-70567-0481		AX-70567-0515	15-80-1144	A-70567-0549		AX-70567-0583	
16	15-80-1162	A-70567-0414		AX-70567-0448	15-80-1163	A-70567-0482		AX-70567-0516	15-80-1164	A-70567-0550		AX-70567-0584	
18	15-80-1182	A-70567-0415		AX-70567-0449	15-80-1183	A-70567-0483		AX-70567-0517	15-80-1184	A-70567-0551		AX-70567-0585	
20	15-80-1202	A-70567-0416		AX-70567-0450	15-80-1203	A-70567-0484		AX-70567-0518	15-80-1204	A-70567-0552		AX-70567-0586	
22	15-80-1222	A-70567-0417		AX-70567-0451	15-80-1223	A-70567-0485		AX-70567-0519	15-80-1224	A-70567-0553		AX-70567-0587	
24	15-80-1242	A-70567-0418		AX-70567-0452	15-80-1243	A-70567-0486		AX-70567-0520	15-80-1244	A-70567-0554		AX-70567-0588	
26	15-80-1262	A-70567-0419		AX-70567-0453	15-80-1263	A-70567-0487		AX-70567-0521	15-80-1264	A-70567-0555		AX-70567-0589	
28	15-80-1282	A-70567-0420		AX-70567-0454	15-80-1283	A-70567-0488		AX-70567-0522	15-80-1284	A-70567-0556		AX-70567-0590	
30	15-80-1302	A-70567-0421		AX-70567-0455	15-80-1303	A-70567-0489		AX-70567-0523	15-80-1304	A-70567-0557		AX-70567-0591	
32	15-80-1322	A-70567-0422		AX-70567-0456	15-80-1323	A-70567-0490		AX-70567-0524	15-80-1324	A-70567-0558		AX-70567-0592	
34	15-80-1342	A-70567-0423		AX-70567-0457	15-80-1343	A-70567-0491		AX-70567-0525	15-80-1344	A-70567-0559		AX-70567-0593	
36	15-80-1362	A-70567-0424		AX-70567-0458	15-80-1363	A-70567-0492		AX-70567-0526	15-80-1364	A-70567-0560		AX-70567-0594	
38	15-80-1382	A-70567-0425		AX-70567-0459	15-80-1383	A-70567-0493		AX-70567-0527	15-80-1384	A-70567-0561		AX-70567-0595	
40	15-80-1402	A-70567-0426		AX-70567-0460	15-80-1403	A-70567-0494		AX-70567-0528	15-80-1404	A-70567-0562		AX-70567-0596	
42	15-80-1422	A-70567-0427		AX-70567-0461	15-80-1423	A-70567-0495		AX-70567-0529	15-80-1424	A-70567-0563		AX-70567-0597	
44	15-80-1442	A-70567-0428		AX-70567-0462	15-80-1443	A-70567-0496		AX-70567-0530	15-80-1444	A-70567-0564		AX-70567-0598	
46	15-80-1462	A-70567-0429		AX-70567-0463	15-80-1463	A-70567-0497		AX-70567-0531	15-80-1464	A-70567-0565		AX-70567-0599	
48	15-80-1482	A-70567-0430		AX-70567-0464	15-80-1483	A-70567-0498		AX-70567-0532	15-80-1484	A-70567-0566		AX-70567-0600	
50	15-80-1502	A-70567-0431		AX-70567-0465	15-80-1503	A-70567-0499		AX-70567-0533	15-80-1504	A-70567-0567		AX-70567-0601	
52	15-80-1522	A-70567-0432		AX-70567-0466	15-80-1523	A-70567-0500		AX-70567-0534	15-80-1524	A-70567-0568		AX-70567-0602	
54	15-80-1542	A-70567-0433		AX-70567-0467	15-80-1543	A-70567-0501		AX-70567-0535	15-80-1544	A-70567-0569		AX-70567-0603	
56	15-80-1562	A-70567-0434		AX-70567-0468	15-80-1563	A-70567-0502		AX-70567-0536	15-80-1564	A-70567-0570		AX-70567-0604	
58	15-80-1582	A-70567-0435		AX-70567-0469	15-80-1583	A-70567-0503		AX-70567-0537	15-80-1584	A-70567-0571		AX-70567-0605	
60	15-80-1602	A-70567-0436		AX-70567-0470	15-80-1603	A-70567-0504		AX-70567-0538	15-80-1604	A-70567-0572		AX-70567-0606	
62	15-80-1622	A-70567-0437		AX-70567-0471	15-80-1623	A-70567-0505		AX-70567-0539	15-80-1624	A-70567-0573		AX-70567-0607	
64	15-80-1642	A-70567-0438		AX-70567-0472	15-80-1643	A-70567-0506		AX-70567-0540	15-80-1644	A-70567-0574		AX-70567-0608	
66	15-80-1662	A-70567-0439		AX-70567-0473	15-80-1663	A-70567-0507		AX-70567-0541	15-80-1664	A-70567-0575		AX-70567-0609	
68	15-80-1682	A-70567-0440		AX-70567-0474	15-80-1683	A-70567-0508		AX-70567-0542	15-80-1684	A-70567-0576		AX-70567-0610	
70	15-80-1702	A-70567-0441		AX-70567-0475	15-80-1703	A-70567-0509		AX-70567-0543	15-80-1704	A-70567-0577		AX-70567-0611	
72	15-80-1722	A-70567-0442		AX-70567-0476	15-80-1723	A-70567-0510		AX-70567-0544	15-80-1724	A-70567-0578		AX-70567-0612	

SYMBOL	
	= C
	= C
	= C
	= C
	= C
	= C
	= C
	= C
	= C

DOCUMENT STATUS P1 RELEASE DATE 2020/05/06 14:13:05

SPECIAL - WITH VOIDS

CKTS SIZE	ENGINEERING NUMBER A-70567	EDP NUMBER 70567-9003	E REF. .130 (3.30)	C $\pm \frac{.015}{(0.38)}$.315 (8.00)	K $\pm \frac{.015}{(0.38)}$.415 (10.54)	VOID CKTS 10	CONNECTOR END PLATING		P.C. BOARD END PLATING			PACKAGING INFORMATION PK-70873- 0018
							TYPE GOLD		D MEAS. .100 (2.54)	TYPE TIN		

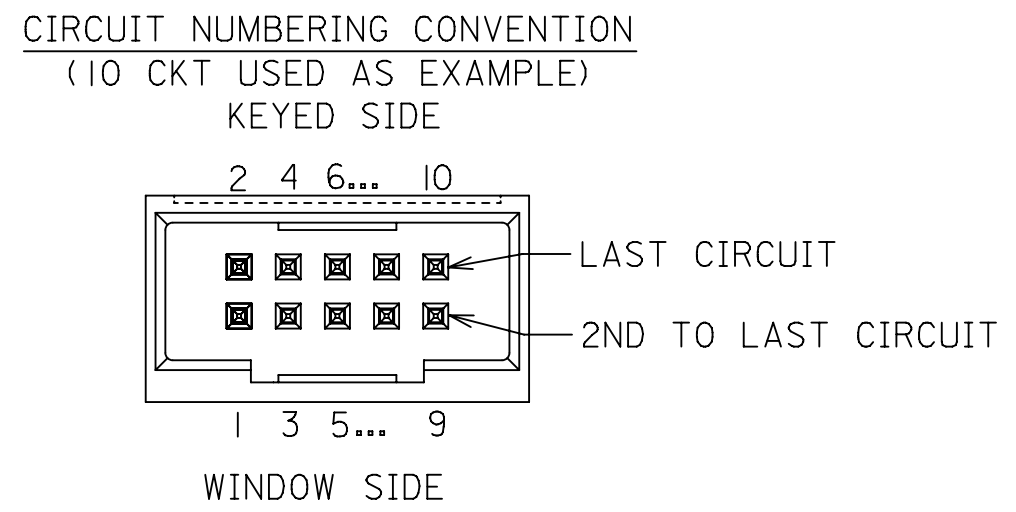

SYMBOLS	THIS DRAWING CONTAINS INFORMATION THAT IS PROPRIETARY TO MOLEX ELECTRONIC TECHNOLOGIES, LLC AND SHOULD NOT BE USED WITHOUT WRITTEN PERMISSION										
	DIMENSION UNITS	SCALE	CURRENT REV DESC:							molex	
	MM	1:1									
	GENERAL TOLERANCES (UNLESS SPECIFIED)		EC NO: 637057			DRWN: ABABUPS 2020/05/05		4 SIDES SHROUDED HEADER			
▽ = 0	4 PLACES ±	MM	INCH	CHK'D: MRAMAKRISHNA 2020/05/06			HIGH TEMP, (2.54)/.100 GRID W/ (0.64)/.025 PINS				
▽ = 0	3 PLACES ±	± 0.005		APPR: MRAMAKRISHNA 2020/05/06			PRODUCT CUSTOMER DRAWING				
▽ = 0	2 PLACES ±	± 0.13	± 0.01	INITIAL REVISION:			DOCUMENT NUMBER		DOC TYPE	DOC PART	REVISION
▽ = 0	1 PLACE ±	± 0.25	±	DRWN:			SDA-70567-XXXX		PSD	001	K5
▽ = 0	0 PLACES ±	±		APPR:			MATERIAL NUMBER		CUSTOMER	SHEET NUMBER	
▽ = 0	ANGULAR TOL ± 0.5 °	THIRD ANGLE PROJECTION		DRAWING		SERIES	GENERAL MARKET		7 OF 8		
▽ = 0	DRAFT WHERE APPLICABLE MUST REMAIN WITHIN DIMENSIONS	C-SIZE		70567							

--	--	--	--

J

H

G

F

E

D









C

B

A

DOCUMENT STATUS	P1	RELEASE DATE	2020/05/06	14:13:05
-----------------	----	--------------	------------	----------

20	19	18	17	16	15	14	13	12	11	10	9	8
----	----	----	----	----	----	----	----	----	----	----	---	---

SYMBOL	
	= C
	= C
	= C
	= C
	= C
	= C
	= C
	= C
	= C

X-ON Electronics

Largest Supplier of Electrical and Electronic Components

Click to view similar products for [Headers & Wire Housings](#) category:

Click to view products by [Molex](#) manufacturer:

Other Similar products are found below :

[892-18-020-10-001101](#) [58102-G61-06LF](#) [582553-1](#) [0009485154](#) [009176003701906](#) [0050291907](#) [LY20-4P-DT1-P1E-BR](#) [02.125.8002.8](#)
[609-3404](#) [61062-3](#) [622-0430](#) [622-3653LF](#) [63453-116](#) [636-1030](#) [636-1427](#) [636-3427](#) [636-4007](#) [641938-9](#) [641991-4](#) [644827-2](#) [65817-010LF](#)
[65817-015LF](#) [65863-015LF](#) [66207-023LF](#) [67095-007LF](#) [67601157](#) [68648-049](#) [70.362.1628.0](#) [70-4210](#) [70-4226B](#) [70-4853B](#) [707-5020](#) [707-](#)
[5028](#) [71.350.2428.0](#) [71918-208LF](#) [71961-016LF](#) [733-134](#) [733-162](#) [754199-000](#) [760-3052](#) [787-8014-00](#) [79531-3000](#) [FCN-360C032-B](#) [FCN-](#)
[367T-T012/H](#) [FCN-723D010/2](#) [80.063.4001.1](#) [800-90-001-10-001000](#) [800-90-010-10-002000](#) [801-43-002-10-013000](#) [801-43-006-10-002000](#)