

SECTION A-A

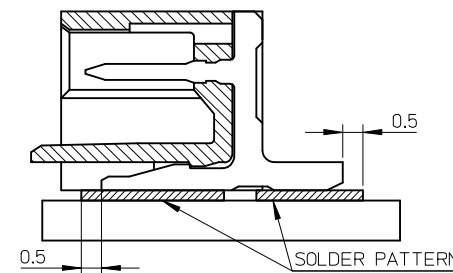

MOUNTING POSITION OF THE CONNECTOR

NOTES:

- MATERIALS:  
HOUSING : GLASS-FILLED LIQUID CRYSTAL POLYMER, UL RATED 94V-0  
COLOR: BEIGE  
PINS: BRASS ALLOY, C26000
- PLATING: 2.54µM MIN. TIN OVER 1.27µM MIN. NICKEL EXCEPT AT CUT-EDGE WHERE THICKNESS CAN BE 1.90µM MIN.
- CUT-EDGE TIN MEASUREMENT POINT.
- DRAWING SHOWS PLUG WITH 5 CIRCUITS.
- HEADER TO BE USED WITH CRIMP HOUSING, P/N 87439 AND CRIMP TERMINAL, P/N 87421
- PRODUCT SPEC. PS-78047-001 APPLIES.

REVISED EC NO: J2014-0698 DRWNR: HORI CHKD: KASAKAWA APPR: NUKITA	DESCRIPTION 2013/10/24 2013/10/22 2013/10/22	GENERAL TOLERANCES (UNLESS SPECIFIED)		DIMENSION STYLE MM ONLY	SCALE NTS	DESIGN UNITS METRIC	THIRD ANGLE PROJECTION
		10 UNDER	±0.20	DRAWN BY SKANG	DATE 2007/07/18	TITLE	HEADER, 150MM PITCH W-T-B, R/A, SMT
		10 OVER 30 UNDER	±0.20	CHECKED BY ATSEE	DATE 2007/07/25	molex	
		30 OVER	±0.20	APPROVED BY MLONG	DATE 2007/07/25		
ANGULAR	±3 °	MATERIAL NO.	DOCUMENT NO.	SD-78048-001	SHEET NO. 1 OF 3		
DRAFT WHERE APPLICABLE MUST REMAIN WITHIN DIMENSIONS		SIZE A3	THIS DRAWING CONTAINS INFORMATION THAT IS PROPRIETARY TO MOLEX INCORPORATED AND SHOULD NOT BE USED WITHOUT WRITTEN PERMISSION				

10 9 8 7 6 5 4 3 2 1

HOUSING COLOUR	HEADER IN TUBE PACKING	HEADER IN TAPE & REEL (W/O HOLE)	HEADER IN TAPE & REEL (WITH HOLE)	STATUS	CKT SIZE	A	B	C	D	E
BIEGE	78048-0242	78048-0243	---	M	2	1.50	3.30	3.70	4.30	1.70
	78048-0342	78048-0343	---	M	3	3.00	4.80	5.20	5.80	3.20
	78048-0442	78048-0443	---	M	4	4.50	6.30	6.70	7.30	4.70
	78048-0542	78048-0543	---	M	5	6.00	7.80	8.20	8.80	6.20
	78048-0642	78048-0643	---	M	6	7.50	9.30	9.70	10.30	7.70
	78048-0742	78048-0743	78048-0744	M	7	9.00	10.80	11.20	11.80	9.20
	78048-0842	78048-0843	---	M	8	10.50	12.30	12.70	13.30	10.70
	78048-0942	78048-0943	---	M	9	12.00	13.80	14.20	14.80	12.20
	78048-1042	78048-1043	---	M	10	13.50	15.30	15.70	16.30	13.70
	78048-1142	78048-1143	---	M	11	15.00	16.80	17.20	17.80	15.20
	78048-1242	78048-1243	---	M	12	16.50	18.30	18.70	19.30	16.70
	78048-1342	78048-1343	---	M	13	18.00	19.80	20.20	20.80	18.20
	78048-1442	78048-1443	---	M	14	19.50	21.30	21.70	22.30	19.70
	78048-1542	78048-1543	---	M	15	21.00	22.80	23.20	23.80	21.20

NOTES:  
 REFER SHEET 3 FOR EMBOSSED TAPE POCKET HOLE DETAIL & POSITION

REVISED EC NO: J2014-0698 2013/10/21 DRWN:RHORI 2013/10/22 CHKD:KASAKAWA 2013/10/22 APPR:NUKITA	DESCRIPTION	GENERAL TOLERANCES (UNLESS SPECIFIED)	DIMENSION STYLE MM ONLY	SCALE NTS	DESIGN UNITS METRIC	THIRD ANGLE PROJECTION
	REV	10 UNDER ± 0.20	DRAWN BY SKANG DATE 2007/07/18	TITLE HEADER, 150MM PITCH W-T-B, R/A, SMT		
		10 OVER 30 UNDER ± 0.20	CHECKED BY ATSEE DATE 2007/07/25	 DOCUMENT NO. SD-78048-001 SHEET NO. 2 OF 3		
		30 OVER ± 0.20	APPROVED BY MLONG DATE 2007/07/25			
		ANGULAR ± 3 ° DRAFT WHERE APPLICABLE MUST REMAIN WITHIN DIMENSIONS	MATERIAL NO. SEE TABLE	THIS DRAWING CONTAINS INFORMATION THAT IS PROPRIETARY TO MOLEX INCORPORATED AND SHOULD NOT BE USED WITHOUT WRITTEN PERMISSION		

9 8 7 6 5 4 3 2

10	9	8	7	6	5	4	3	2	1
15	44	20.20	100	44.40	50.40				
11, 12, 13, 14	32	14.20	100	32.40	38.40				
7, 8, 9, 10	24	11.50	100	24.40	30.40				
2, 3, 4, 5, 6	16	7.50	100	16.40	22.40				
CIRCUIT SIZE	A	B	N	G	T MAX				

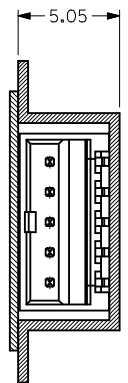
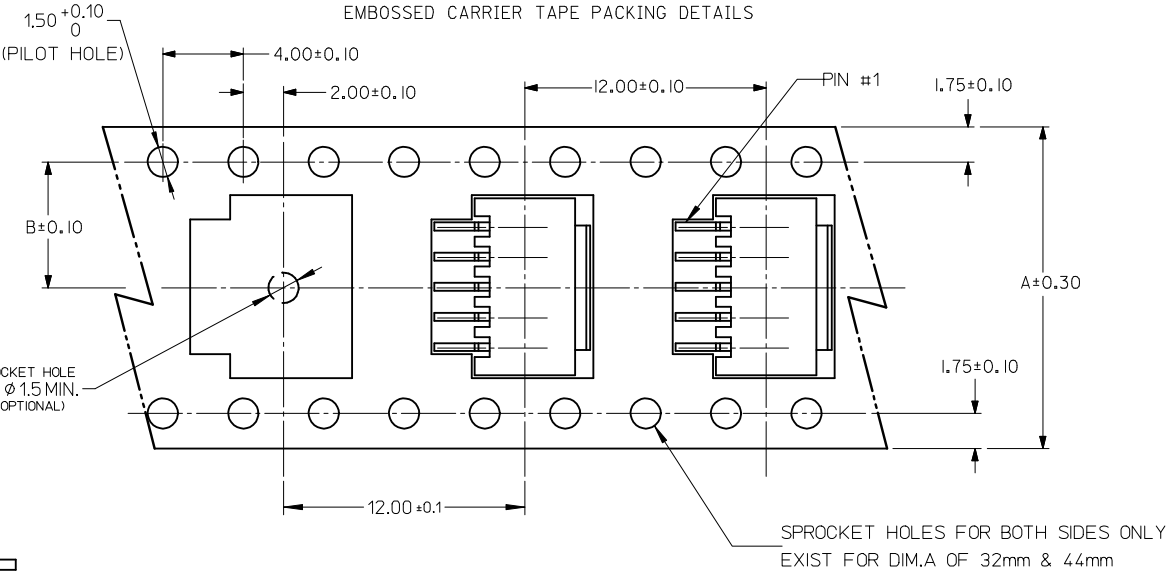

REEL DETAILS

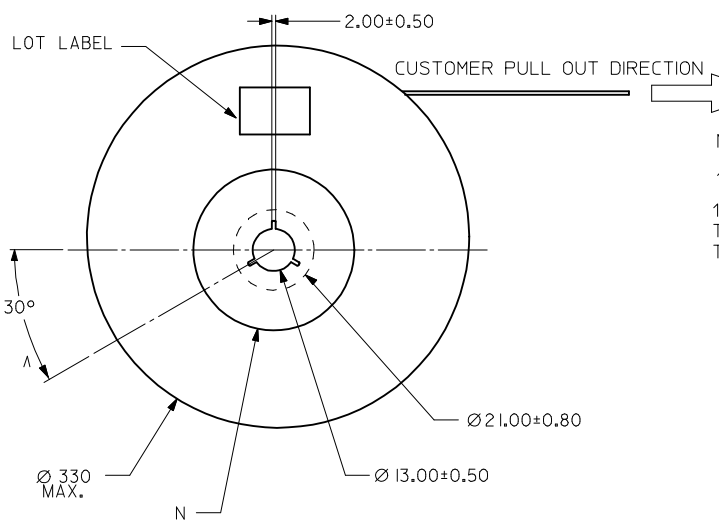

NOTES:

- LEADER AND TRAILER TAPE

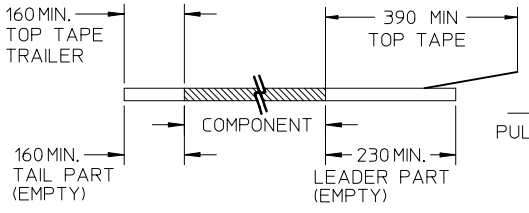

- PEELING OFF FORCE OF THE TOP TAPE: 20-80gf. (PEELING DIRECTION AS SHOWN IN FOLLOWING FIGURE)

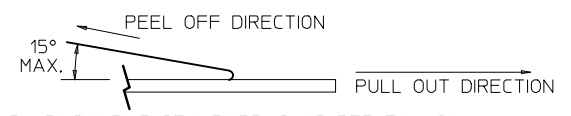

- PACKAGING STANDARD IS AS PER EIA-481.
- TAPE & REEL QUANTITY = 1000PCS/REEL
- THE TAPE IS TREATED FOR ANTI-STATIC

REVISED EC NO: J2014-0698 2013/10/21 DRW:RHORI CHKD:KASAKAWA 2013/10/22 APPR:NUK ITA 2013/10/22	DESCRIPTION	GENERAL TOLERANCES (UNLESS SPECIFIED)		DIMENSION STYLE	SCALE	DESIGN UNITS	THIRD ANGLE PROJECTION	
				MM ONLY	NTS	METRIC		
		10 UNDER	± 0.20	DRAWN BY	DATE	TITLE		
		10 OVER 30 UNDER	± 0.20	SKANG	2007/07/18	HEADER, 150MM PITCH W-T-B, R/A, SMT		
	30 OVER	± 0.20	CHECKED BY	DATE				
			ATSEE	2007/07/25				
			APPROVED BY	DATE				
			MLONG	2007/07/25				
			MATERIAL NO.	SEE TABLE		DOCUMENT NO.	SHEET NO.	
						SD-78048-001	3 OF 3	
			ANGULAR	± 3 °				
			DRAFT WHERE APPLICABLE MUST REMAIN WITHIN DIMENSIONS					
			SIZE	THIS DRAWING CONTAINS INFORMATION THAT IS PROPRIETARY TO MOLEX INCORPORATED AND SHOULD NOT BE USED WITHOUT WRITTEN PERMISSION				
			A3					

## X-ON Electronics

Largest Supplier of Electrical and Electronic Components

*Click to view similar products for [Headers & Wire Housings](#) category:*

*Click to view products by [Molex](#) manufacturer:*

Other Similar products are found below :

[95000-104TRLF](#) [10135584-644402LF](#) [DF62W-EP2022PCA](#) [95000-106TRLF](#) [DF62W-2022SCA](#) [DF62W-EP2022PC](#) [2203348](#) [DF62W-2022SC](#) [1084018](#) [1029039](#) [1084017](#) [802-10-012-10-002000](#) [1112640](#) [1112639](#) [891-007-9SS-BST1T](#) [000-34000](#) [0008550134](#) [0009482033](#) [0009507031](#) [57102-F02-18ULF](#) [57102-S06-03LF](#) [57202-S52-04LF](#) [PCN6-15S-2.5E](#) [0039019024](#) [58102-G61-06LF](#) [582553-1](#) [0009485154](#) [0009508121](#) [0022285053](#) [0050291907](#) [018731A](#) [LY20-4P-DT1-P1E-BR](#) [02.125.8002.8](#) [60101931](#) [60598-1 \(Cut Strip\)](#) [M1625-3R/100](#) [61062-3](#) [61082-181009](#) [CSU011177004](#) [636-1427](#) [638009-1](#) [641938-9](#) [641991-4](#) [644168-1](#) [644827-2](#) [647662-1](#) [65039-019ELF](#) [65692-001LF](#) [65781-018](#) [65781-047](#)