

FEATURES SELECTION GUIDE

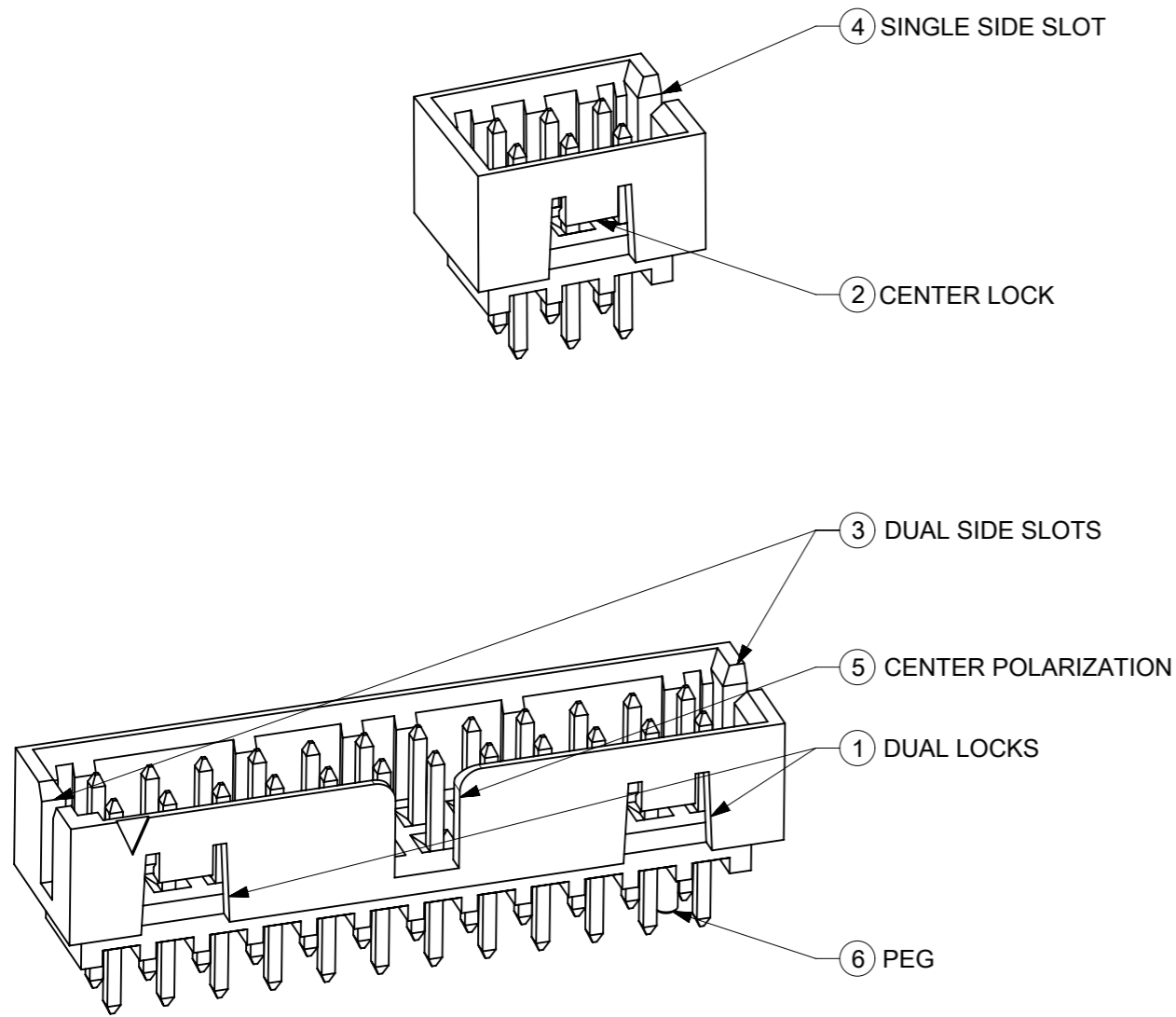

CIRCUIT SIZE	FRICTION LOCKS		SIDE SLOTS		⑤ CENTER POLARIZATION	⑥ PEG	SHEET NO
	① DUAL	② CENTER	③ DUAL	④ SINGLE			
4	N.A	N.A	YES	N.A	N.A	N.A	2 - 3
	N.A	YES	YES	N.A	N.A	N.A	
	N.A	YES	N.A	YES	N.A	N.A	
6	N.A	N.A	YES	N.A	N.A	N.A	4 - 5
	N.A	N.A	YES	N.A	N.A	YES	
	N.A	YES	YES	N.A	N.A	N.A	
	N.A	YES	YES	N.A	N.A	YES	
	N.A	YES	N.A	YES	N.A	N.A	
	N.A	N.A	YES	N.A	YES	N.A	
8 TO 12	N.A	N.A	YES	N.A	YES	N.A	6 - 8
	N.A	N.A	YES	N.A	YES	YES	
	N.A	YES	YES	N.A	N.A	N.A	
	N.A	YES	YES	N.A	N.A	YES	
	N.A	YES	N.A	YES	N.A	N.A	
	N.A	YES	N.A	YES	N.A	YES	
14 TO 50	YES	N.A	YES	N.A	YES	N.A	9 - 13
	YES	N.A	YES	N.A	YES	YES	

PACKAGING SPECIFICATION TABLE

TAPE AND REEL PACKAGING	PK-87831-300	
TUBE STANDARD PACKAGING	PK-87831-001	
TUBE NON-STANDARD PACKAGING FOR:	PK-87831-002	
87831-0419		87831-0645
87831-5141		87831-5119
87831-0443		87831-1011
87831-5241		87831-1420
87831-5242		
87831-0643		

SYMBOLS	THIS DRAWING CONTAINS INFORMATION THAT IS PROPRIETARY TO MOLEX ELECTRONIC TECHNOLOGIES, LLC AND SHOULD NOT BE USED WITHOUT WRITTEN PERMISSION		CURRENT REV DESC: ADDED BTB DIST.		
	DIMENSION UNITS SCALE GENERAL TOLERANCES (UNLESS SPECIFIED)	mm NTS			
4 PLACES ± 3 PLACES ± 2 PLACES ± 0.2 ± 1 PLACE ± ± 0 PLACES ± ± ANGULAR TOL ± 3.0°	MM INCH	EC NO: 619055 DRWN: NMANE02 2019/03/25 CHK'D: NMANE02 2019/07/09 APPR: MRAMAKRISHNA 2019/07/09			PRODUCT CUSTOMER DRAWING
DRAFT WHERE APPLICABLE MUST REMAIN WITHIN DIMENSIONS	THIRD ANGLE PROJECTION	DRAWING A3-SIZE	SERIES 87831	MATERIAL NUMBER SEE TABLE	CUSTOMER GENERAL MARKET
		DOCUMENT NUMBER SD-87831-0001	DOC TYPE PSD	DOC PART 001	REVISION A16
				SHEET NUMBER 1 OF 14	

4 CIRCUITS

CKT SIZE	ASSY P/N WITHOUT CAP IN TUBE	ASSY P/N WITH CAP IN TUBE	ASSY P/N WITH CAP IN T&R	PLATING OPTIONS	FRICTION LOCKS		SIDE SLOTS		CENTER POLARIZATION	PEG	DIMENSION													
					DUAL	CENTER	DUAL	SINGLE			A	B	C	D	E	F	G	H						
4	87831-0419	N.A	N.A	1	N.A	N.A	YES	N.A	N.A	N.A	2.00	4.85	6.65	5.00	N.A	N.A	2.50	3.60±0.20						
	87831-0420	N.A	N.A	2																				
	87831-0421	N.A	N.A	3																				
	87831-0436	N.A	N.A	4																				
	87831-0441	87831-0456	N.A	2	N.A	YES	YES	N.A	N.A	N.A						N.A	N.A		N.A	N.A	N.A	1.00	2.50	3.60±0.20
	87831-0442	N.A	87831-5565	3																				
	87831-5141	N.A	N.A	2	N.A	YES	YES	N.A	N.A	N.A						N.A	N.A		N.A	N.A	N.A	1.00	3.50	3.60±0.20
	87831-5142	N.A	N.A	3																				
	87831-6141	N.A	N.A	2	N.A	YES	YES	N.A	N.A	N.A						N.A	N.A		N.A	N.A	N.A	1.00	2.80	3.60±0.20
	87831-6142	N.A	N.A	3																				
	87831-0443	N.A	N.A	2	N.A	YES	N.A	YES	N.A	N.A						N.A	N.A		N.A	N.A	N.A	1.00	2.50	3.60±0.20
	87831-0444	N.A	N.A	3																				

PLATING OPTIONS:

- 1 - 0.05-0.13µm/2-5µin GOLD IN CONTACT AREA AND 1.88µm/75µin MIN. MATTE TIN IN SOLDER TAIL AREA OVER 1.27µm/50µin MIN. NICKEL OVERALL.
- 2 - 0.38µm/15µin GOLD IN CONTACT AREA AND 1.88µm/75µin MIN. MATTE TIN IN SOLDER TAIL AREA OVER 1.27µm/50µin MIN. NICKEL OVERALL.
- 3 - 0.76µm/30µin GOLD IN CONTACT AREA AND 1.88µm/75µin MIN. MATTE TIN IN SOLDER TAIL AREA OVER 1.27µm/50µin MIN. NICKEL OVERALL.
- 4 - 2.50µm/100µin MIN. MATTE TIN OVER 1.25µm/50µin MIN. NICKEL OVERALL.

THIS DRAWING CONTAINS INFORMATION THAT IS PROPRIETARY TO MOLEX ELECTRONIC TECHNOLOGIES, LLC AND SHOULD NOT BE USED WITHOUT WRITTEN PERMISSION												
SYMBOLS	DIMENSION UNITS		SCALE		CURRENT REV DESC: ADDED BTB DIST.							
	mm	NTS	molex									
▽ = 0	GENERAL TOLERANCES (UNLESS SPECIFIED)				MILLIGRID							
▽ = 0					2MM PITCH, THROUGH HOLE VERTICAL SHROUDED HEADER							
▽ = 0					PRODUCT CUSTOMER DRAWING							
▽ = 0					EC NO: 619055			DOCUMENT NUMBER				
▽ = 0					DRWN: NMANE02 2019/03/25			SD-87831-0001				
▽ = 0					CHK'D: NMANE02 2019/07/09			DOC TYPE DOC PART REVISION				
▽ = 0					APPR: MRAMAKRISHNA 2019/07/09			PSD 001 A16				
▽ = 0					INITIAL REVISION:							
▽ = 0					DRWN: GMENARLY 2015/04/15			MATERIAL NUMBER				
▽ = 0					APPR: KHLIM 2015/06/29			CUSTOMER				
▽ = 0					ANGULAR TOL ± 3.0°			SEE TABLE				
▽ = 0					DRAFT WHERE APPLICABLE MUST REMAIN WITHIN DIMENSIONS			GENERAL MARKET				
▽ = 0					THIRD ANGLE PROJECTION		DRAWING		SERIES		SHEET NUMBER	
▽ = 0					A3-SIZE		87831		3 OF 14			

6 CIRCUITS

CKT SIZE	ASSY P/N WITHOUT CAP IN TUBE	ASSY P/N WITH CAP IN TUBE	ASSY P/N WITH CAP IN T&R	PLATING OPTIONS	FRICTION LOCKS		SIDE SLOTS		CENTER POLARIZATION	PEG	DIMENSION													
					DUAL	CENTER	DUAL	SINGLE			A	B	C	D	E	F	G	H						
6	87831-0619	N.A	N.A	1	N.A	N.A	YES	N.A	N.A	N.A	4.00	6.85	8.65	7.00	N.A	N.A	2.50	3.60±0.20						
	87831-0620	N.A	N.A	2																				
	87831-0621	N.A	N.A	3																				
	87831-0636	N.A	N.A	4																				
	87831-0628	N.A	N.A	2	N.A	N.A	YES	N.A	N.A	YES						N.A	N.A		N.A	2.50	N.A	2.50	N.A	2.50
	87831-0629	N.A	N.A	3																				
	87831-0641	N.A	N.A	2	N.A	YES	YES	N.A	N.A	N.A						N.A	N.A		N.A	2.50	N.A	2.80	N.A	2.50
	87831-0642	N.A	87831-5552	3																				
	87831-5241	N.A	N.A	2	N.A	YES	YES	N.A	N.A	N.A						N.A	N.A		N.A	2.50	N.A	2.50	N.A	2.50
	87831-5242	N.A	N.A	3																				
	87831-6241	N.A	N.A	2	N.A	YES	YES	N.A	N.A	N.A						N.A	N.A		N.A	2.50	N.A	2.50	N.A	2.50
	87831-6242	N.A	N.A	3																				
	87831-0643	N.A	N.A	2	N.A	YES	N.A	YES	N.A	N.A						N.A	N.A		N.A	2.50	N.A	2.50	N.A	2.50
	87831-0644	N.A	N.A	3																				
	87831-0645	N.A	N.A	2	N.A	YES	N.A	YES	N.A	N.A						YES	N.A		N.A	2.50	N.A	2.50	N.A	3.60 ^{+0.15} -0.10
	87831-0646	N.A	N.A	3																				
	87831-0632	N.A	N.A	2	N.A	YES	YES	N.A	N.A	YES						N.A	N.A		N.A	2.50	N.A	2.50	N.A	2.50
	87831-5119	N.A	N.A	1																				
87831-5121	N.A	N.A	3	N.A	N.A	YES	N.A	YES	N.A	N.A	N.A	N.A	N.A	2.50	N.A	2.50	3.60±0.20							
87831-5136	N.A	N.A	4																					

PLATING OPTIONS:

- 1 - 0.05-0.13µm/2-5µm GOLD IN CONTACT AREA AND 1.88µm/75µm MIN. MATTE TIN IN SOLDER TAIL AREA OVER 1.27µm/50µm MIN. NICKEL OVERALL.
- 2 - 0.38µm/15µm GOLD IN CONTACT AREA AND 1.88µm/75µm MIN. MATTE TIN IN SOLDER TAIL AREA OVER 1.27µm/50µm MIN. NICKEL OVERALL.
- 3 - 0.76µm/30µm GOLD IN CONTACT AREA AND 1.88µm/75µm MIN. MATTE TIN IN SOLDER TAIL AREA OVER 1.27µm/50µm MIN. NICKEL OVERALL.
- 4 - 2.50µm/100µm MIN. MATTE TIN OVER 1.25µm/50µm MIN. NICKEL OVERALL.

SYMBOLS	THIS DRAWING CONTAINS INFORMATION THAT IS PROPRIETARY TO MOLEX ELECTRONIC TECHNOLOGIES, LLC AND SHOULD NOT BE USED WITHOUT WRITTEN PERMISSION		CURRENT REV DESC: ADDED BTB DIST.			
	DIMENSION UNITS	SCALE	GENERAL TOLERANCES (UNLESS SPECIFIED)			
▽ = 0	mm	NTS	EC NO: 619055		MILLIGRID	
▽ = 0	GENERAL TOLERANCES (UNLESS SPECIFIED)		DRWN: NMANE02 2019/03/25		2MM PITCH, THROUGH HOLE VERTICAL SHROUDED HEADER	
▽ = 0	MM INCH		CHK'D: NMANE02 2019/07/09		PRODUCT CUSTOMER DRAWING	
▽ = 0	4 PLACES ±	±	APPR: MRAMAKRISHNA 2019/07/09		DOCUMENT NUMBER	
▽ = 0	3 PLACES ±	±	INITIAL REVISION:		DOC TYPE DOC PART REVISION	
▽ = 0	2 PLACES ±	0.2 ±	DRWN: GMENARLY 2015/04/15		SD-87831-0001 PSD 001 A16	
▽ = 0	1 PLACE ±	±	APPR: KHLIM 2015/06/29		MATERIAL NUMBER CUSTOMER	
▽ = 0	0 PLACES ±	±	THIRD ANGLE PROJECTION		SEE TABLE GENERAL MARKET	
▽ = 0	ANGULAR TOL ± 3.0°		DRAWING		SHEET NUMBER	
▽ = 0	DRAFT WHERE APPLICABLE MUST REMAIN WITHIN DIMENSIONS		A3-SIZE 87831		5 OF 14	

8 TO 12 CIRCUITS

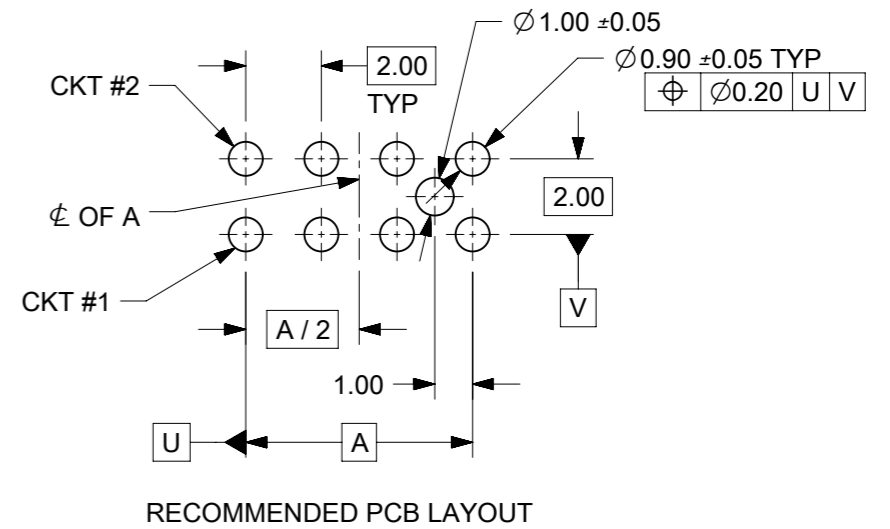
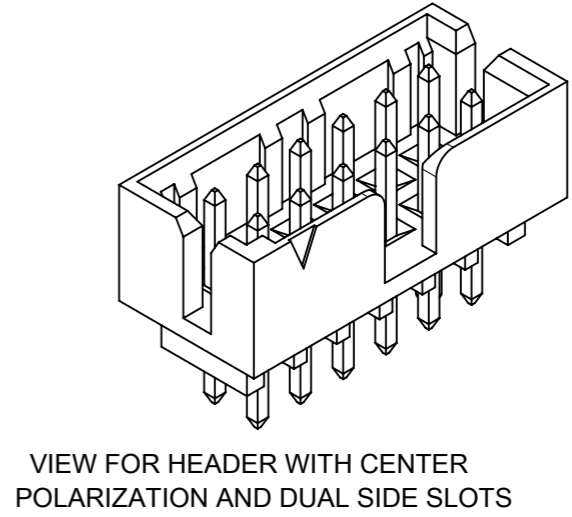
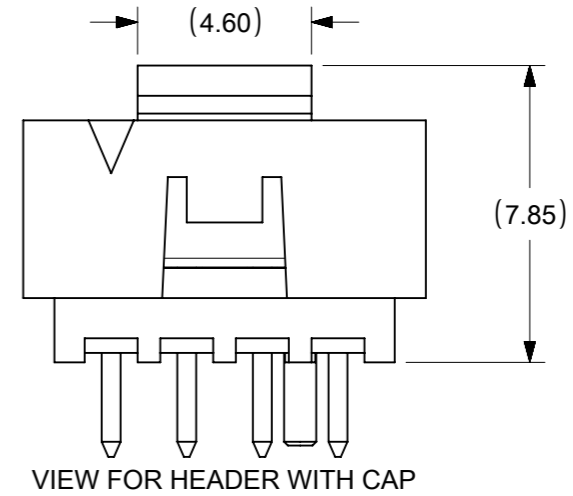
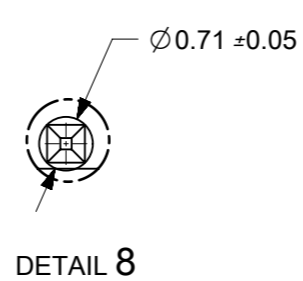
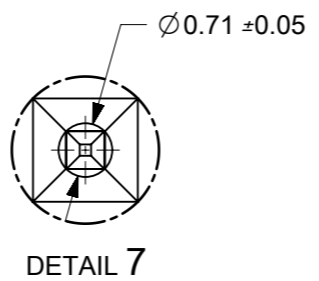
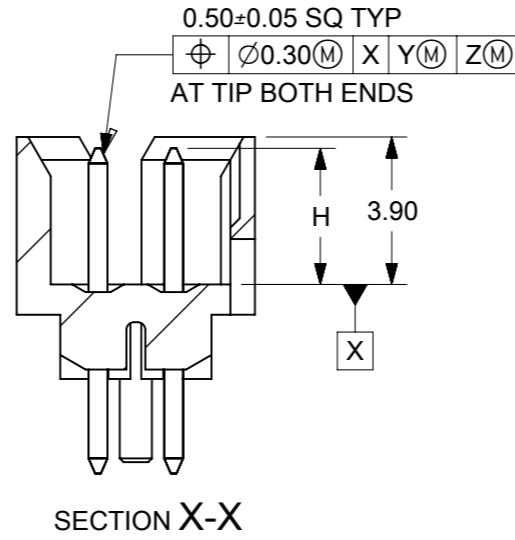
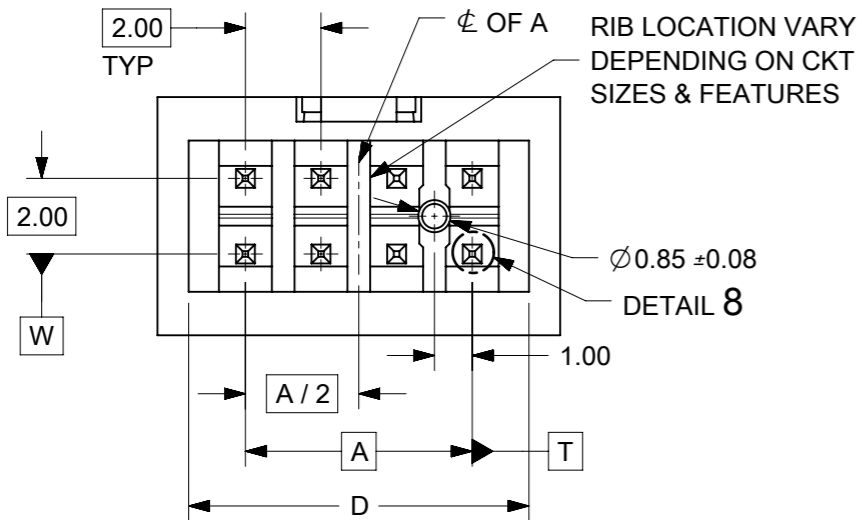
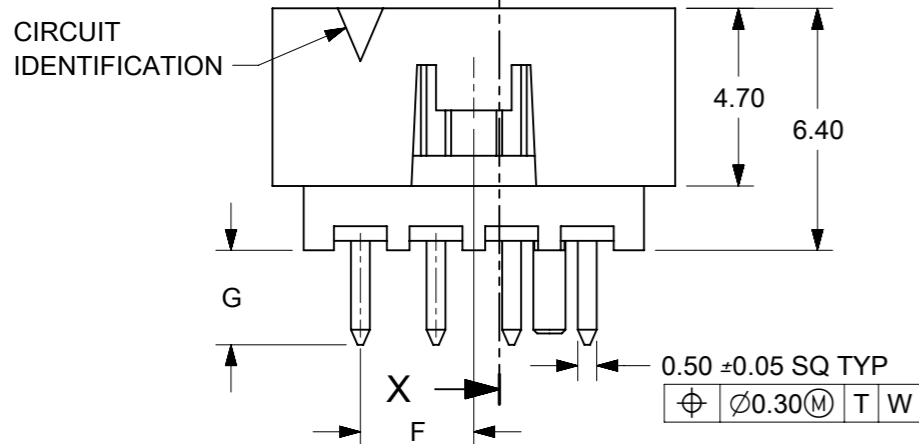
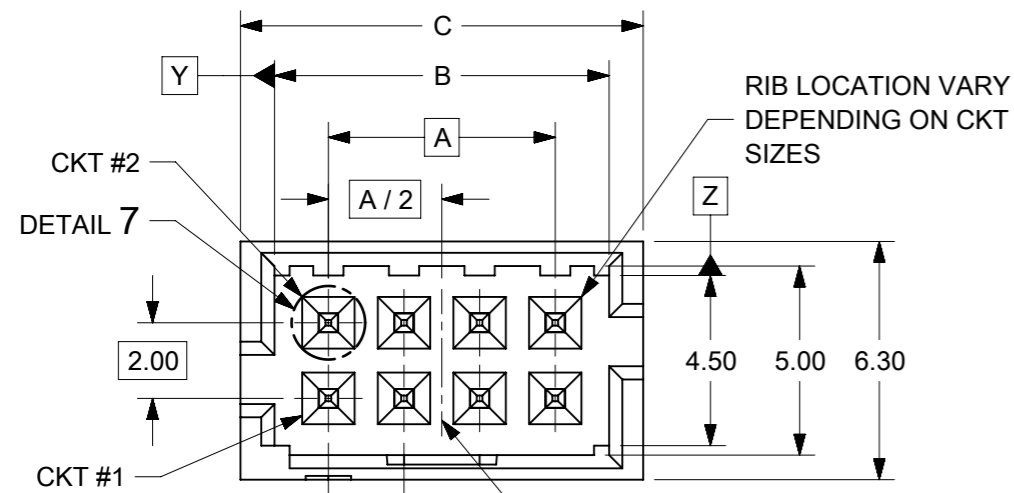

- NOTES:
- MATERIALS:
HOUSING: 30% GF, NYLON, UL94V-0, COLOR: BLACK
PIN: 0.50mm SQ PHOSPHOR BRONZE
 - FINISHES: REFER TO PLATING OPTIONS
 - PRODUCT SPECIFICATION: PS-87831-027
 - PACKAGING SPECIFICATION: SEE PACKAGING SPECS TABLE ON SHEET 1
 - MATES WITH: A. MOLEX CRIMP RECEPTACLE HOUSING: 51110 SERIES AND CRIMP TERMINAL: 50394 SERIES
B. MOLEX 2mm MILLIGRID DUAL ROW IDT: 87568 SERIES
C. MOLEX 2mm MILLIGRID DUAL ROW RECEPTACLE: 79107 (GOLD PLATED), 78787 (TIN PLATED)

SYMBOLS	THIS DRAWING CONTAINS INFORMATION THAT IS PROPRIETARY TO MOLEX ELECTRONIC TECHNOLOGIES, LLC AND SHOULD NOT BE USED WITHOUT WRITTEN PERMISSION		CURRENT REV DESC: ADDED BTB DIST.			
	DIMENSION UNITS	SCALE				
▽ = 0	mm	NTS			MILLIGRID 2MM PITCH, THROUGH HOLE VERTICAL SHROUDED HEADER	
▽ = 0	GENERAL TOLERANCES (UNLESS SPECIFIED)					
▽ = 0		MM	INCH			PRODUCT CUSTOMER DRAWING DOCUMENT NUMBER: SD-87831-0001 DOC TYPE: PSD DOC PART: 001 REVISION: A16
▽ = 0	4 PLACES ±	±	±			
▽ = 0	3 PLACES ±	±	±			EC NO: 619055 DRWN: NMANE02 2019/03/25 CHK'D: NMANE02 2019/07/09 APPR: MRAMAKRISHNA 2019/07/09
▽ = 0	2 PLACES ±	0.2	±			
▽ = 0	1 PLACE ±	±	±			INITIAL REVISION: DRWN: GMENARLY 2015/04/15 APPR: KHLIM 2015/06/29
▽ = 0	0 PLACES ±	±	±			
▽ = 0	ANGULAR TOL	± 3.0°				MATERIAL NUMBER: SEE TABLE CUSTOMER: GENERAL MARKET SHEET NUMBER: 6 OF 14
▽ = 0	DRAFT WHERE APPLICABLE MUST REMAIN WITHIN DIMENSIONS		THIRD ANGLE PROJECTION			
▽ = 0			DRAWING: A3-SIZE		SERIES: 87831	

10 TO 12 CIRCUITS

CKT SIZE	ASSY P/N WITHOUT CAP IN TUBE	ASSY P/N WITH CAP IN TUBE	ASSY P/N WITH CAP IN T&R	PLATING OPTIONS	FRICTION LOCKS		SIDE SLOTS		CENTER POLARIZATION	PEG	DIMENSION									
					DUAL	CENTER	DUAL	SINGLE			A	B	C	D	E	F	G	H		
10	87831-1019	N.A	N.A	1	N.A	N.A	YES	N.A	YES	N.A	8.00	10.85	12.65	11.00	N.A	N.A	2.50	3.60±0.20		
	87831-1020	N.A	N.A	2																
	87831-1021	N.A	87831-5562	3																
	87831-1036	N.A	N.A	4																
	87831-1010	N.A	87831-5561	2																
	87831-1011	N.A	N.A	3																
	87831-1028	N.A	N.A	2	N.A	N.A	YES	N.A	YES	YES						N.A	4.00		2.50	2.50
	87831-1029	N.A	87831-5557	3																
	87831-1035	N.A	N.A	3																
	87831-1041	N.A	N.A	2	N.A	YES	YES	N.A	N.A	N.A						N.A	5.00		2.50	2.50
	87831-1042	N.A	87831-5553	3																
	87831-1032	N.A	N.A	2																
	87831-1043	N.A	N.A	2	N.A	YES	N.A	YES	N.A	N.A						N.A	5.00		2.50	2.50
	87831-1044	N.A	N.A	3																
	87831-1045	N.A	N.A	2																
87831-1046	N.A	N.A	3	N.A	YES	N.A	YES	N.A	YES	N.A	5.00	2.50	2.50							
87831-1219	N.A	N.A	1																	
87831-1220	N.A	87831-5556	2																	
87831-1221	N.A	N.A	3	N.A	N.A	YES	N.A	YES	N.A	10.00	12.85	14.65	13.00	N.A	N.A	2.50	3.60±0.20			
87831-1236	N.A	N.A	4																	
87831-1228	N.A	N.A	2																	
87831-1229	N.A	87831-5558	3																	
87831-1258	N.A	(A13) 87831-5567	2																	
87831-1241	N.A	N.A	2																	
87831-1242	N.A	N.A	3	N.A	YES	YES	N.A	N.A	N.A						5.00	2.50		2.50		
87831-1255	87831-1256	N.A	2																	
87831-1232	N.A	N.A	2																	
87831-1243	N.A	N.A	2	N.A	YES	N.A	YES	N.A	N.A						5.00	2.50		2.50		
87831-1244	N.A	N.A	3																	
87831-1245	N.A	N.A	2																	
87831-1246	N.A	N.A	3	N.A	YES	N.A	YES	N.A	YES						5.00	2.50		2.50		

PLATING OPTIONS:

- 1 - 0.05-0.13µm/2-5µin GOLD IN CONTACT AREA AND 1.88µm/75µin MIN. MATTE TIN IN SOLDER TAIL AREA OVER 1.27µm/50µin MIN. NICKEL OVERALL.
- 2 - 0.38µm/15µin GOLD IN CONTACT AREA AND 1.88µm/75µin MIN. MATTE TIN IN SOLDER TAIL AREA OVER 1.27µm/50µin MIN. NICKEL OVERALL.
- 3 - 0.76µm/30µin GOLD IN CONTACT AREA AND 1.88µm/75µin MIN. MATTE TIN IN SOLDER TAIL AREA OVER 1.27µm/50µin MIN. NICKEL OVERALL.
- 4 - 2.50µm/100µin MIN. MATTE TIN OVER 1.25µm/50µin MIN. NICKEL OVERALL.

SYMBOLS	THIS DRAWING CONTAINS INFORMATION THAT IS PROPRIETARY TO MOLEX ELECTRONIC TECHNOLOGIES, LLC AND SHOULD NOT BE USED WITHOUT WRITTEN PERMISSION	
	DIMENSION UNITS	SCALE
▽ = 0	mm	NTS
▽ = 0	CURRENT REV DESC: ADDED BTB DIST.	
▽ = 0	GENERAL TOLERANCES (UNLESS SPECIFIED)	
▽ = 0	MM	INCH
▽ = 0	4 PLACES ±	±
▽ = 0	3 PLACES ±	±
▽ = 0	2 PLACES ±	0.2 ±
▽ = 0	1 PLACE ±	±
▽ = 0	0 PLACES ±	±
▽ = 0	ANGULAR TOL ±	3.0°
▽ = 0	DRAFT WHERE APPLICABLE MUST REMAIN WITHIN DIMENSIONS	THIRD ANGLE PROJECTION
▽ = 0		DRAWING
		SERIES
		MATERIAL NUMBER
		CUSTOMER
		SHEET NUMBER

EC NO: 619055	DRWN: NMANE02	2019/03/25
CHK'D: NMANE02	2019/07/09	
APPR: MRAMAKRISHNA	2019/07/09	
INITIAL REVISION:		
DRWN: GMENARLY	2015/04/15	
APPR: KHLIM	2015/06/29	

molex		
MILLIGRID		
2MM PITCH, THROUGH HOLE VERTICAL SHROUDED HEADER		
PRODUCT CUSTOMER DRAWING		
DOCUMENT NUMBER	DOC TYPE	DOC PART
SD-87831-0001	PSD	001
REVISION	A16	

DOCUMENT STATUS	P1	RELEASE DATE	2019/07/09	06:47:12
-----------------	----	--------------	------------	----------

14 TO 50 CIRCUITS

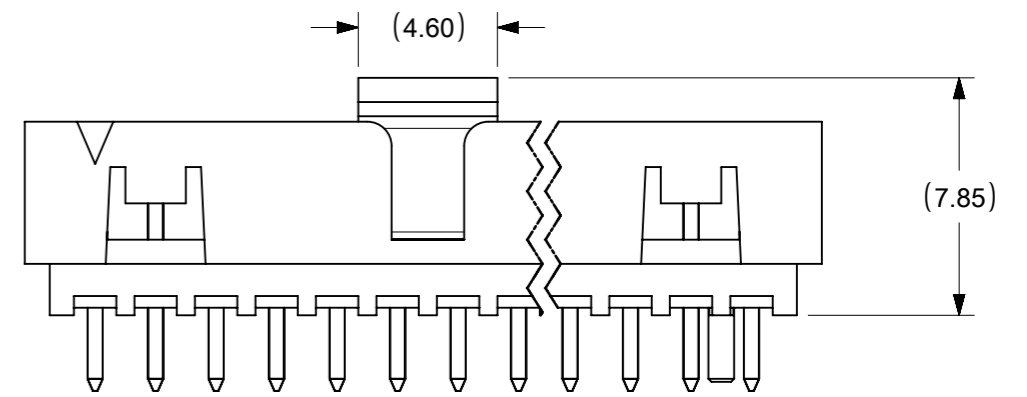
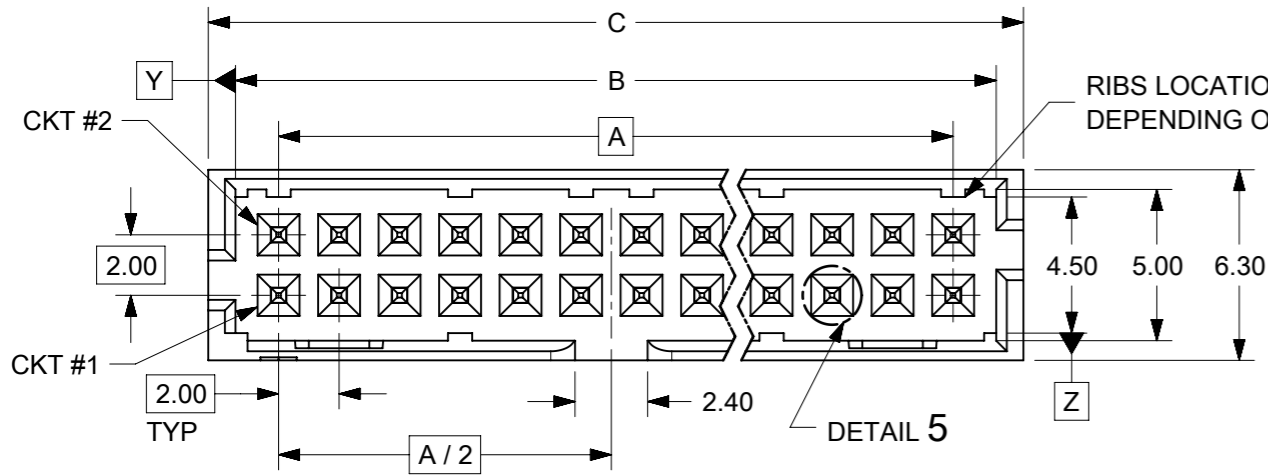

VIEW FOR HEADER WITH CAP

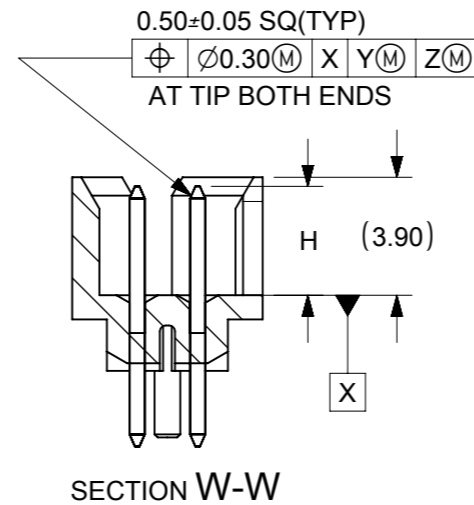
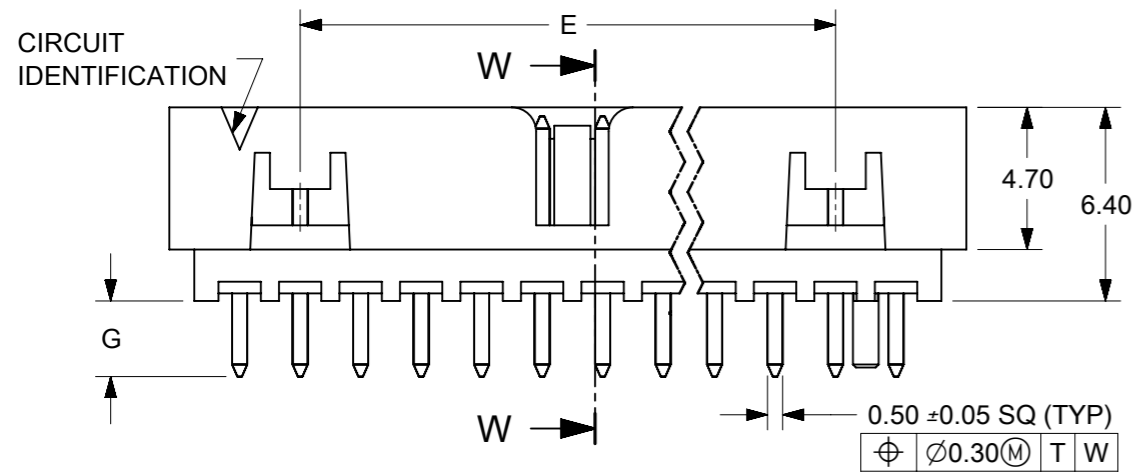

SECTION W-W

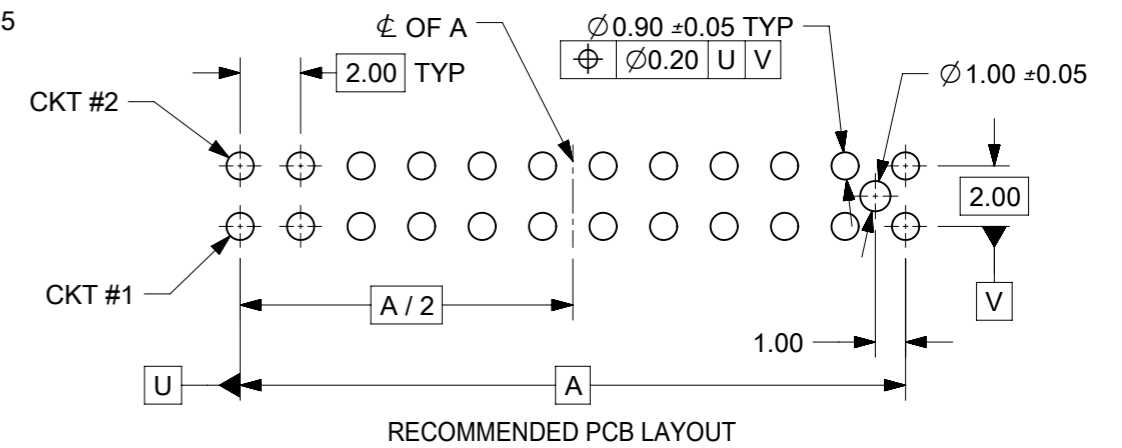
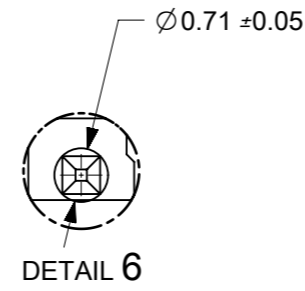
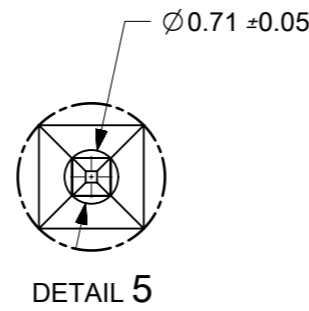
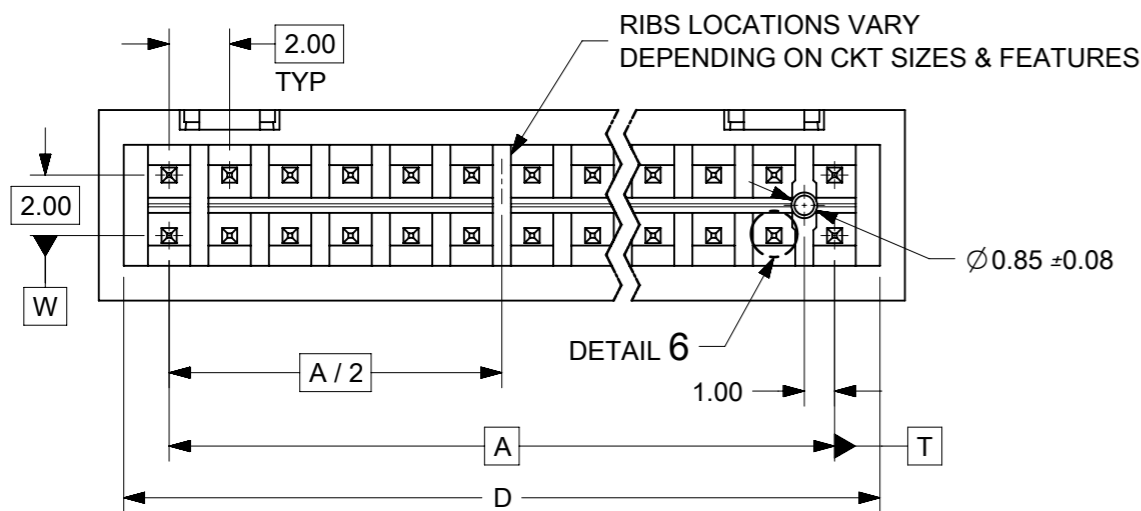

RECOMMENDED PCB LAYOUT

NOTES:

- MATERIALS:**
HOUSING: 30% GF, NYLON, UL94V-0, COLOR: BLACK
PIN: 0.50mm SQ PHOSPHOR BRONZE
- FINISHES:** REFER TO PLATING OPTIONS
- PRODUCT SPECIFICATION:** PS-87831-027
- PACKAGING SPECIFICATION:** SEE PACKAGING SPECS TABLE ON SHEET 1
- MATES WITH:** A. MOLEX CRIMP RECEPTACLE HOUSING: 51110 SERIES AND CRIMP TERMINAL: 50394 SERIES
B. MOLEX 2mm MILLIGRID DUAL ROW IDT: 87568 SERIES
C. MOLEX 2mm MILLIGRID DUAL ROW RECEPTACLE: 79107 (GOLD PLATED), 78787 (TIN PLATED)

SYMBOLS	THIS DRAWING CONTAINS INFORMATION THAT IS PROPRIETARY TO MOLEX ELECTRONIC TECHNOLOGIES, LLC AND SHOULD NOT BE USED WITHOUT WRITTEN PERMISSION		CURRENT REV DESC: ADDED BTB DIST.		
	DIMENSION UNITS	SCALE			
▽ = 0	mm	NTS			2MM PITCH, THROUGH HOLE VERTICAL SHROUDED HEADER
▽ = 0	GENERAL TOLERANCES (UNLESS SPECIFIED)				PRODUCT CUSTOMER DRAWING
▽ = 0		MM	INCH		DOCUMENT NUMBER
▽ = 0	4 PLACES ±				SD-87831-0001
▽ = 0	3 PLACES ±				DOC TYPE
▽ = 0	2 PLACES ±	0.2			PSD
▽ = 0	1 PLACE ±				DOC PART
▽ = 0	0 PLACES ±				001
▽ = 0	ANGULAR TOL ±	3.0°			REVISION
▽ = 0	DRAFT WHERE APPLICABLE MUST REMAIN WITHIN DIMENSIONS		THIRD ANGLE PROJECTION	DRAWING	SERIES
▽ = 0				A3-SIZE	87831
				MATERIAL NUMBER	CUSTOMER
				SEE TABLE	GENERAL MARKET
					SHEET NUMBER
					9 OF 14

14 TO 20 CIRCUITS

CKT SIZE	ASSY P/N WITHOUT CAP IN TUBE	ASSY P/N WITH CAP IN TUBE	ASSY P/N WITH CAP IN T&R	PLATING OPTIONS	FRICTION LOCKS		SIDE SLOTS		CENTER POLARIZATION	PEG	DIMENSION							
					DUAL	CENTER	DUAL	SINGLE			A	B	C	D	E	F	G	H
14	87831-1419	N.A	N.A	1	YES	N.A	YES	N.A	YES	N.A	12.00	14.85	16.65	15.00	8.00	N.A	2.50	3.60±0.20
	87831-1420	87831-1430	87831-5554	2														
	87831-1421	N.A	87831-5560	3														
	87831-1436	N.A	N.A	4														
	87831-1428	N.A	(A14) 87831-5564	2	YES	N.A	YES	N.A	YES	YES								
	87831-1429	N.A	87831-5563	3														
	87831-1435	N.A	N.A	3														
	87831-1410	N.A	N.A	2														
87831-1411	N.A	N.A	3	YES	N.A	YES	N.A	YES	N.A	3.50								
16	87831-1619	N.A	N.A	1	YES	N.A	YES	N.A	YES	N.A	14.00	16.85	18.65	17.00	10.00	N.A	2.50	3.60±0.20
	87831-1620	N.A	N.A	2														
	87831-1621	N.A	N.A	3														
	87831-1636	N.A	N.A	4	YES	N.A	YES	N.A	YES	YES								
	87831-1628	N.A	N.A	2														
	87831-1629	N.A	87831-5559	3														
	87831-1635	N.A	N.A	3														
18	87831-1819	N.A	N.A	1	YES	N.A	YES	N.A	YES	N.A	16.00	18.85	20.65	19.00	12.00	N.A	2.50	3.60±0.20
	87831-1820	N.A	87831-5566	2														
	87831-1821	N.A	N.A	3														
	87831-1836	N.A	N.A	4	YES	N.A	YES	N.A	YES	YES								
	87831-1828	N.A	N.A	2														
	87831-1829	N.A	N.A	3														
20	87831-2019	N.A	N.A	1	YES	N.A	YES	N.A	YES	N.A	18.00	20.85	22.65	21.00	14.00	N.A	2.50	3.60±0.20
	87831-2020	N.A	N.A	2														
	87831-2021	N.A	N.A	3														
	87831-2036	N.A	N.A	4	YES	N.A	YES	N.A	YES	YES								
	87831-2028	N.A	N.A	2														
	87831-2029	N.A	N.A	3														
	87831-2035	N.A	N.A	3														
	87831-2010	N.A	N.A	2	YES	N.A	YES	N.A	YES	N.A								
87831-2011	N.A	(A13) 87831-2041	3															

PLATING OPTIONS:

- 1 - 0.05-0.13µm/2-5µm GOLD IN CONTACT AREA AND 1.88µm/75µm MIN. MATTE TIN IN SOLDER TAIL AREA OVER 1.27µm/50µm MIN. NICKEL OVERALL.
- 2 - 0.38µm/15µm GOLD IN CONTACT AREA AND 1.88µm/75µm MIN. MATTE TIN IN SOLDER TAIL AREA OVER 1.27µm/50µm MIN. NICKEL OVERALL.
- 3 - 0.76µm/30µm GOLD IN CONTACT AREA AND 1.88µm/75µm MIN. MATTE TIN IN SOLDER TAIL AREA OVER 1.27µm/50µm MIN. NICKEL OVERALL.
- 4 - 2.50µm/100µm MIN. MATTE TIN OVER 1.25µm/50µm MIN. NICKEL OVERALL.

SYMBOLS ▽ = 0 ▽ = 0 ▽ = 0 ▽ = 0 ▽ = 0 ▽ = 0 ▽ = 0 ▽ = 0 ▽ = 0 ▽ = 0	DIMENSION UNITS mm	SCALE NTS	THIS DRAWING CONTAINS INFORMATION THAT IS PROPRIETARY TO MOLEX ELECTRONIC TECHNOLOGIES, LLC AND SHOULD NOT BE USED WITHOUT WRITTEN PERMISSION CURRENT REV DESC: ADDED BTB DIST.					
	GENERAL TOLERANCES (UNLESS SPECIFIED)							
	4 PLACES ± ± 3 PLACES ± ± 2 PLACES ± 0.2 ± 1 PLACE ± ± 0 PLACES ± ± ANGULAR TOL ± 3.0°							
	DRAFT WHERE APPLICABLE MUST REMAIN WITHIN DIMENSIONS			EC NO: 619055 DRWN: NMANE02 2019/03/25 CHK'D: NMANE02 2019/07/09 APPR: MRAMAKRISHNA 2019/07/09 INITIAL REVISION: DRWN: GMENARLY 2015/04/15 APPR: KHLIM 2015/06/29				
DOCUMENT STATUS P1 RELEASE DATE 2019/07/09 06:47:12		THIRD ANGLE PROJECTION 		DRAWING A3-SIZE	SERIES 87831	MATERIAL NUMBER SEE TABLE	CUSTOMER GENERAL MARKET	SHEET NUMBER 10 OF 14

22 TO 30 CIRCUITS

CKT SIZE	ASSY P/N WITHOUT CAP IN TUBE	ASSY P/N WITH CAP IN TUBE	ASSY P/N WITH CAP IN T&R	ASSY P/N WITHOUT CAP IN T&R	PLATING OPTIONS	FRICTION LOCKS		SIDE SLOTS		CENTER POLARIZATION	PEG	DIMENSION							
						DUAL	CENTER	DUAL	SINGLE			A	B	C	D	E	F	G	H
22	87831-2219	N.A	N.A	N.A	1	YES	N.A	YES	N.A	YES	N.A	20.00	22.85	24.65	23.00	16.00	N.A	2.50	3.60±0.20
	87831-2220	N.A	N.A	N.A	2														
	87831-2221	N.A	N.A	N.A	3														
	87831-2236	N.A	N.A	N.A	4														
	87831-2228	N.A	N.A	N.A	2														
	87831-2229	N.A	N.A	N.A	3														
24	87831-2419	N.A	N.A	N.A	1	YES	N.A	YES	N.A	YES	N.A	22.00	24.85	26.65	25.00	18.00	N.A	2.50	3.60±0.20
	87831-2420	N.A	N.A	87831-7420	2														
	87831-2421	N.A	N.A	N.A	3														
	87831-2436	N.A	N.A	N.A	4														
	87831-2428	N.A	N.A	N.A	2														
	87831-2429	N.A	N.A	N.A	3														
	87831-2435	N.A	N.A	N.A	3														
	87831-2445	N.A	N.A	N.A	3														
87831-2410	N.A	N.A	N.A	2															
26	87831-2619	N.A	N.A	N.A	1	YES	N.A	YES	N.A	YES	N.A	24.00	26.85	28.65	27.00	20.00	N.A	2.50	3.60±0.20
	87831-2620	87831-2630	87831-5555	N.A	2														
	87831-2621	N.A	N.A	N.A	3														
	87831-2636	N.A	N.A	N.A	4														
	87831-2628	N.A	N.A	N.A	2														
	87831-2629	N.A	N.A	N.A	3														
	87831-2610	N.A	N.A	N.A	2														
28	87831-2819	N.A	N.A	N.A	1	YES	N.A	YES	N.A	YES	N.A	26.00	28.85	30.65	29.00	22.00	N.A	2.50	3.60±0.20
	87831-2820	N.A	N.A	N.A	2														
	87831-2821	N.A	N.A	N.A	3														
	87831-2836	N.A	N.A	N.A	4														
	87831-2828	N.A	N.A	N.A	2														
	87831-2829	N.A	N.A	N.A	3														
30	87831-3019	N.A	N.A	N.A	1	YES	N.A	YES	N.A	YES	N.A	28.00	30.85	32.65	31.00	24.00	N.A	2.50	3.60±0.20
	87831-3020	N.A	N.A	N.A	2														
	87831-3021	N.A	N.A	N.A	3														
	87831-3036	N.A	N.A	N.A	4														
	87831-3028	N.A	N.A	N.A	2														
	87831-3029	N.A	N.A	N.A	3														
	87831-3035	N.A	N.A	N.A	3														
	87831-3010	87831-3030	87831-3050	N.A	2														

PLATING OPTIONS:

- 1 - 0.05-0.13µm/2-5µin GOLD IN CONTACT AREA AND 1.88µm/75µin MIN. MATTE TIN IN SOLDER TAIL AREA OVER 1.27µm/50µin MIN. NICKEL OVERALL.
- 2 - 0.38µm/15µin GOLD IN CONTACT AREA AND 1.88µm/75µin MIN. MATTE TIN IN SOLDER TAIL AREA OVER 1.27µm/50µin MIN. NICKEL OVERALL.
- 3 - 0.76µm/30µin GOLD IN CONTACT AREA AND 1.88µm/75µin MIN. MATTE TIN IN SOLDER TAIL AREA OVER 1.27µm/50µin MIN. NICKEL OVERALL.
- 4 - 2.50µm/100µin MIN. MATTE TIN OVER 1.25µm/50µin MIN. NICKEL OVERALL.

SYMBOLS	THIS DRAWING CONTAINS INFORMATION THAT IS PROPRIETARY TO MOLEX ELECTRONIC TECHNOLOGIES, LLC AND SHOULD NOT BE USED WITHOUT WRITTEN PERMISSION									
	DIMENSION UNITS		SCALE		CURRENT REV DESC: ADDED BTB DIST.					
	mm		NTS		 MILLIGRID 2MM PITCH, THROUGH HOLE VERTICAL SHROUDED HEADER PRODUCT CUSTOMER DRAWING					
	GENERAL TOLERANCES (UNLESS SPECIFIED)									
▽ = 0	4 PLACES ±	MM	INCH	EC NO: 619055		DRWN: NMANE02 2019/03/25				
▽ = 0	3 PLACES ±			DRWN: NMANE02 2019/07/09		CHK'D: NMANE02 2019/07/09				
▽ = 0	2 PLACES ± 0.2			APPR: MRAMAKRISHNA 2019/07/09		INITIAL REVISION:				
▽ = 0	1 PLACE ±			DRWN: GMENARLY 2015/04/15		DOCUMENT NUMBER				
☒ = 0	ANGULAR TOL ± 3.0°			APPR: KHLIM 2015/06/29		SD-87831-0001		DOC TYPE	DOC PART	REVISION
■ = 0	DRAFT WHERE APPLICABLE MUST REMAIN WITHIN DIMENSIONS	THIRD ANGLE PROJECTION		DRAWING	SERIES	MATERIAL NUMBER	CUSTOMER	SHEET NUMBER		
▽ = 0				A3-SIZE	87831	SEE TABLE	GENERAL MARKET	11 OF 14		

32 TO 40 CIRCUITS

CKT SIZE	ASSY P/N WITHOUT CAP IN TUBE	ASSY P/N WITH CAP IN TUBE	ASSY P/N WITH CAP IN T&R	PLATING OPTIONS	FRICTION LOCKS		SIDE SLOTS		CENTER POLARIZATION	PEG	DIMENSION							
					DUAL	CENTER	DUAL	SINGLE			A	B	C	D	E	F	G	H
32	87831-3219	N.A	N.A	1	YES	N.A	YES	N.A	YES	N.A	30.00	32.85	34.65	33.00	26.00	N.A	2.50	3.60±0.20
	87831-3220	N.A	N.A	2														
	87831-3221	N.A	N.A	3														
	87831-3236	N.A	N.A	4														
	87831-3228	N.A	N.A	2														
	87831-3229	N.A	N.A	3	YES	N.A	YES	N.A	YES	YES							2.50	
34	87831-3419	N.A	N.A	1	YES	N.A	YES	N.A	YES	N.A	32.00	34.85	36.65	35.00	28.00	N.A	2.50	3.60±0.20
	87831-3420	N.A	N.A	2														
	87831-3421	N.A	N.A	3														
	87831-3436	N.A	N.A	4														
	87831-3428	N.A	N.A	2														
	87831-3429	N.A	N.A	3	YES	N.A	YES	N.A	YES	YES							2.50	
	87831-3435	N.A	N.A	3	YES	N.A	YES	N.A	YES	YES							3.50	
36	87831-3619	N.A	N.A	1	YES	N.A	YES	N.A	YES	N.A	34.00	36.85	38.65	37.00	30.00	N.A	2.50	3.60±0.20
	87831-3620	N.A	87831-5564	2														
	87831-3621	N.A	N.A	3														
	87831-3636	N.A	N.A	4														
	87831-3628	N.A	N.A	2														
	87831-3629	N.A	N.A	3	YES	N.A	YES	N.A	YES	YES							2.50	
38	87831-3819	N.A	N.A	1	YES	N.A	YES	N.A	YES	N.A	36.00	38.85	40.65	39.00	32.00	N.A	2.50	3.60±0.20
	87831-3820	N.A	N.A	2														
	87831-3821	N.A	N.A	3														
	87831-3836	N.A	N.A	4														
	87831-3828	N.A	N.A	2														
	87831-3829	N.A	N.A	3	YES	N.A	YES	N.A	YES	YES							2.50	
40	87831-4019	N.A	N.A	1	YES	N.A	YES	N.A	YES	N.A	38.00	40.85	42.65	41.00	34.00	N.A	2.50	3.60±0.20
	87831-4020	N.A	N.A	2														
	87831-4021	N.A	N.A	3														
	87831-4036	N.A	N.A	4														
	87831-4028	N.A	N.A	2														
	87831-4029	N.A	N.A	3	YES	N.A	YES	N.A	YES	YES							2.50	
	87831-4010	N.A	N.A	2	YES	N.A	YES	N.A	YES	N.A							3.50	

PLATING OPTIONS:

- 1 - 0.05-0.13µm/2-5µin GOLD IN CONTACT AREA AND 1.88µm/75µin MIN. MATTE TIN IN SOLDER TAIL AREA OVER 1.27µm/50µin MIN. NICKEL OVERALL.
- 2 - 0.38µm/15µin GOLD IN CONTACT AREA AND 1.88µm/75µin MIN. MATTE TIN IN SOLDER TAIL AREA OVER 1.27µm/50µin MIN. NICKEL OVERALL.
- 3 - 0.76µm/30µin GOLD IN CONTACT AREA AND 1.88µm/75µin MIN. MATTE TIN IN SOLDER TAIL AREA OVER 1.27µm/50µin MIN. NICKEL OVERALL.
- 4 - 2.50µm/100µin MIN. MATTE TIN OVER 1.25µm/50µin MIN. NICKEL OVERALL.

SYMBOLS		THIS DRAWING CONTAINS INFORMATION THAT IS PROPRIETARY TO MOLEX ELECTRONIC TECHNOLOGIES, LLC AND SHOULD NOT BE USED WITHOUT WRITTEN PERMISSION	
▽ = 0	mm	SCALE	CURRENT REV DESC: ADDED BTB DIST.
▽ = 0	NTS		
▽ = 0	GENERAL TOLERANCES (UNLESS SPECIFIED)		molex MILLIGRID 2MM PITCH, THROUGH HOLE VERTICAL SHROUDED HEADER
▽ = 0	MM	INCH	
▽ = 0	4 PLACES ±		EC NO: 619055
▽ = 0	3 PLACES ±		DRWN: NMANE02 2019/03/25
▽ = 0	2 PLACES ± 0.2		CHK'D: NMANE02 2019/07/09
▽ = 0	1 PLACE ±		APPR: MRAMAKRISHNA 2019/07/09
▽ = 0	0 PLACES ±		INITIAL REVISION:
▽ = 0	ANGULAR TOL ± 3.0°		DRWN: GMENARLY 2015/04/15
▽ = 0	DRAFT WHERE APPLICABLE MUST REMAIN WITHIN DIMENSIONS	THIRD ANGLE PROJECTION	APPR: KHLIM 2015/06/29
▽ = 0		DRAWING	SERIES
		A3-SIZE	87831
		MATERIAL NUMBER	CUSTOMER
		SEE TABLE	GENERAL MARKET
		DOCUMENT NUMBER	DOC TYPE DOC PART REVISION
		SD-87831-0001	PSD 001 A16
		SHEET NUMBER	12 OF 14

DOCUMENT STATUS	P1	RELEASE DATE	2019/07/09	06:47:12
-----------------	----	--------------	------------	----------

42 TO 50 CIRCUITS

CKT SIZE	ASSY P/N WITHOUT CAP IN TUBE	ASSY P/N WITH CAP IN TUBE	ASSY P/N WITH CAP IN T&R	PLATING OPTIONS	FRICTION LOCKS		SIDE SLOTS		CENTER POLARIZATION	PEG	DIMENSION							
					DUAL	CENTER	DUAL	SINGLE			A	B	C	D	E	F	G	H
42	87831-4219	N.A	N.A	1	YES	N.A	YES	N.A	YES	N.A	40.00	42.85	44.65	43.00	36.00	N.A	2.50	3.60±0.20
	87831-4220	N.A	N.A	2														
	87831-4221	N.A	N.A	3														
	87831-4236	N.A	N.A	4														
	87831-4228	N.A	N.A	2														
	87831-4229	N.A	N.A	3	YES	N.A	YES	N.A	YES	YES							2.50	
44	87831-4419	N.A	N.A	1	YES	N.A	YES	N.A	YES	N.A	42.00	44.85	46.65	45.00	38.00	N.A	2.50	3.60±0.20
	87831-4420	N.A	N.A	2														
	87831-4421	N.A	N.A	3														
	87831-4436	N.A	N.A	4														
	87831-4428	N.A	N.A	2														
	87831-4429	N.A	N.A	3	YES	N.A	YES	N.A	YES	YES							2.50	
	87831-4435	N.A	N.A	3	YES	N.A	YES	N.A	YES	YES							3.50	
46	87831-4619	N.A	N.A	1	YES	N.A	YES	N.A	YES	N.A	44.00	46.85	48.65	47.00	40.00	N.A	2.50	3.60±0.20
	87831-4620	N.A	N.A	2														
	87831-4621	N.A	N.A	3														
	87831-4636	N.A	N.A	4														
	87831-4628	N.A	N.A	2														
	87831-4629	N.A	N.A	3	YES	N.A	YES	N.A	YES	YES							2.50	
48	87831-4819	N.A	N.A	1	YES	N.A	YES	N.A	YES	N.A	46.00	48.85	50.65	49.00	42.00	N.A	2.50	3.60±0.20
	87831-4820	N.A	N.A	2														
	87831-4821	N.A	N.A	3														
	87831-4836	N.A	N.A	4														
	87831-4828	N.A	N.A	2														
	87831-4829	N.A	N.A	3	YES	N.A	YES	N.A	YES	YES							2.50	
50	87831-5019	N.A	N.A	1	YES	N.A	YES	N.A	YES	N.A	48.00	50.85	52.65	51.00	44.00	N.A	2.50	3.60±0.20
	87831-5020	N.A	N.A	2														
	87831-5021	N.A	N.A	3														
	87831-5036	N.A	N.A	4														
	87831-5028	N.A	N.A	2														
	87831-5029	N.A	N.A	3	YES	N.A	YES	N.A	YES	YES							2.50	
	87831-5035	N.A	N.A	3	YES	N.A	YES	N.A	YES	YES							3.50	







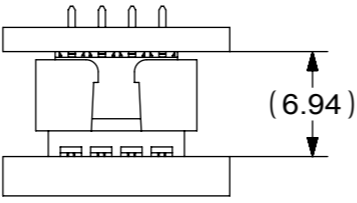
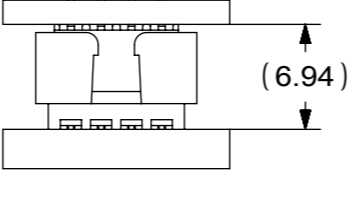
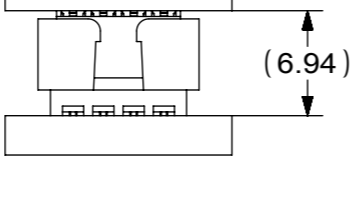
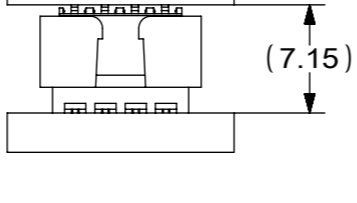
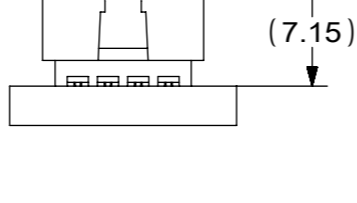

PLATING OPTIONS:

- 1 - 0.05-0.13µm/2-5µin GOLD IN CONTACT AREA AND 1.88µm/75µin MIN. MATTE TIN IN SOLDER TAIL AREA OVER 1.27µm/50µin MIN. NICKEL OVERALL.
- 2 - 0.38µm/15µin GOLD IN CONTACT AREA AND 1.88µm/75µin MIN. MATTE TIN IN SOLDER TAIL AREA OVER 1.27µm/50µin MIN. NICKEL OVERALL.
- 3 - 0.76µm/30µin GOLD IN CONTACT AREA AND 1.88µm/75µin MIN. MATTE TIN IN SOLDER TAIL AREA OVER 1.27µm/50µin MIN. NICKEL OVERALL.
- 4 - 2.50µm/100µin MIN. MATTE TIN OVER 1.25µm/50µin MIN. NICKEL OVERALL.

SYMBOLS ▽ = 0 ▽ = 0 ▽ = 0 ▽ = 0 ▽ = 0 ▽ = 0 ▽ = 0 ▽ = 0 ▽ = 0 ▽ = 0	THIS DRAWING CONTAINS INFORMATION THAT IS PROPRIETARY TO MOLEX ELECTRONIC TECHNOLOGIES, LLC AND SHOULD NOT BE USED WITHOUT WRITTEN PERMISSION DIMENSION UNITS: mm SCALE: NTS CURRENT REV DESC: ADDED BTB DIST.		MILLIGRID 2MM PITCH, THROUGH HOLE VERTICAL SHROUDED HEADER				
	GENERAL TOLERANCES (UNLESS SPECIFIED)			EC NO: 619055 DRWN: NMANE02 2019/03/25 CHK'D: NMANE02 2019/07/09 APPR: MRAMAKRISHNA 2019/07/09			
	PRODUCT CUSTOMER DRAWING			DOCUMENT NUMBER: SD-87831-0001 DOC TYPE: PSD DOC PART: 001 REVISION: A16			
	DRAFT WHERE APPLICABLE MUST REMAIN WITHIN DIMENSIONS			THIRD ANGLE PROJECTION DRAWING: A3-SIZE SERIES: 87831 MATERIAL NUMBER: SEE TABLE CUSTOMER: GENERAL MARKET SHEET NUMBER: 13 OF 14			

BOARD TO BOARD (BTB) DISTANCE

HEADER	MATES WITH (RECEPTACLE)	BTB DIST.	PICTORIAL VIEW
87831	79107	6.94	
	78787	6.94	
	79108	6.94	
	79109	7.15	
	78788	7.15	

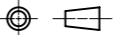
SYMBOLS  = 0  = 0  = 0  = 0  = 0  = 0  = 0	DIMENSION UNITS mm NTS	SCALE NTS	THIS DRAWING CONTAINS INFORMATION THAT IS PROPRIETARY TO MOLEX ELECTRONIC TECHNOLOGIES, LLC AND SHOULD NOT BE USED WITHOUT WRITTEN PERMISSION CURRENT REV DESC: ADDED BTB DIST.		
	GENERAL TOLERANCES (UNLESS SPECIFIED)		EC NO: 619055 DRWN: NMANE02 2019/03/25 CHK'D: NMANE02 2019/07/09 APPR: MRAMAKRISHNA 2019/07/09		 MILLIGRID 2MM PITCH, THROUGH HOLE VERTICAL SHROUDED HEADER
	PRODUCT CUSTOMER DRAWING		INITIAL REVISION: DRWN: DRWN BY XXXX/XX/XX APPR: APPR BY XXXX/XX/XX		
	DOCUMENT NUMBER SD-87831-0001		DOC TYPE PSD	DOC PART 001	REVISION A16
	MATERIAL NUMBER 87831		CUSTOMER GENERAL MARKET		SHEET NUMBER 14 OF 14
	DRAFT WHERE APPLICABLE MUST REMAIN WITHIN DIMENSIONS		THIRD ANGLE PROJECTION 	DRAWING A3-SIZE	SERIES 87831

X-ON Electronics

Largest Supplier of Electrical and Electronic Components

Click to view similar products for [Headers & Wire Housings](#) category:

Click to view products by [Molex](#) manufacturer:

Other Similar products are found below :

[892-18-020-10-001101](#) [58102-G61-06LF](#) [582553-1](#) [0009485154](#) [009176003701906](#) [0050291907](#) [LY20-4P-DT1-P1E-BR](#) [02.125.8002.8](#)
[609-3404](#) [61062-3](#) [622-0430](#) [622-3653LF](#) [63453-116](#) [636-1030](#) [636-1427](#) [636-3427](#) [636-4007](#) [641938-9](#) [641991-4](#) [644827-2](#) [65817-010LF](#)
[65817-015LF](#) [65863-015LF](#) [66207-023LF](#) [67095-007LF](#) [67601157](#) [68648-049](#) [70.362.1628.0](#) [70-4210](#) [70-4226B](#) [70-4853B](#) [707-5020](#) [707-5028](#) [71.350.2428.0](#) [71918-208LF](#) [71961-016LF](#) [733-134](#) [733-162](#) [754199-000](#) [760-3052](#) [787-8014-00](#) [79531-3000](#) [FCN-360C032-B](#) [FCN-367T-T012/H](#) [FCN-723D010/2](#) [80.063.4001.1](#) [800-90-001-10-001000](#) [800-90-010-10-002000](#) [801-43-002-10-013000](#) [801-43-006-10-002000](#)