

10 9 8 7 6 5 4 3 2 1

CIRCUITS	ORDER NO.	DIM. C	DIM. D	DIM. A
2	89400-021*	2.00	0.75	6.00
3	89400-031*	4.00	2.00	8.00
4	89400-041*	6.00	4.00	10.00
5	89400-051*	8.00	6.00	12.00
6	89400-061*	10.00	8.00	14.00
7	89400-071*	12.00	10.00	16.00
8	89400-081*	14.00	12.00	18.00
9	89400-091*	16.00	14.00	20.00
10	89400-101*	18.00	16.00	22.00
11	89400-111*	20.00	18.00	24.00
12	89400-121*	22.00	20.00	26.00
13	89400-131*	24.00	22.00	28.00
14	89400-141*	26.00	24.00	30.00
15	89400-151*	28.00	26.00	32.00
16	89400-161*	30.00	28.00	34.00

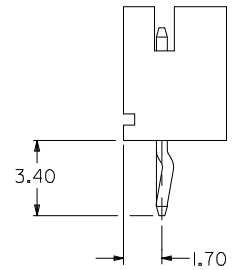
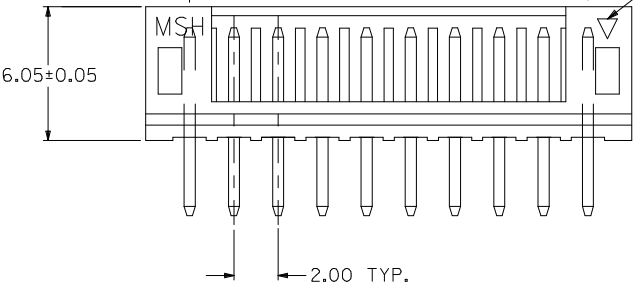
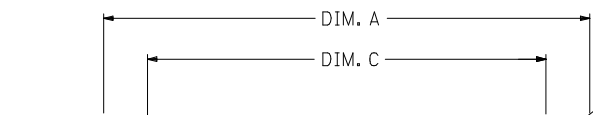
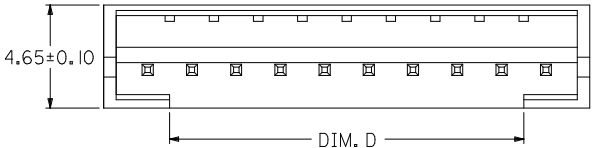
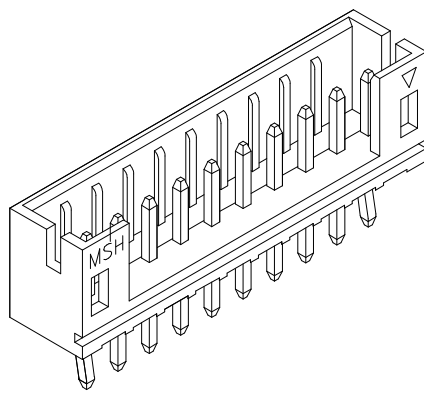
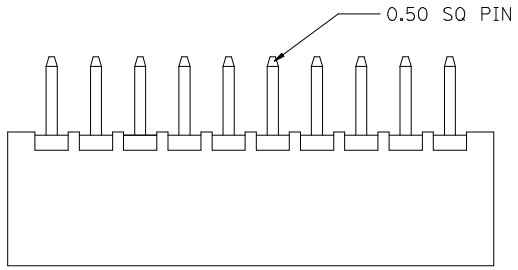

PART NO. LEGEND
89400 - ** I *

CKT SIZE ———— | ————

COLOR OPTION
0 - NATURAL (WHITE)
1 - BLACK
2 - RED
3 - YELLOW
4 - BLUE
6 - GREEN

- NOTE:**
- MATERIALS : HOUSING - NYLON (PA66), UL94 V-0
COLOR : SEE OPTION
TERMINAL - BRASS
 - FINISHES : TERMINAL - TIN THICKNESS 1.27-2.54 MICROMETER OVER
NICKEL THICKNESS 2.54 MICROMETER MIN OVERALL
COPPER THICKNESS 1.07 MICROMETER MIN OVERALL
 - PRODUCT SPECIFICATION : PS-87369-0001
 - BULK PACK IN PVC BAG WITH 1000 PCS PER BAG.

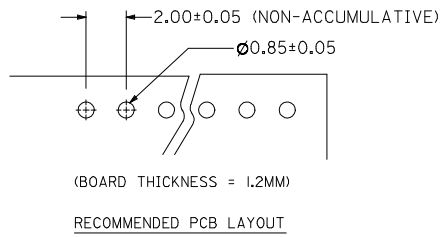

NEW RELEASE EC NO: SH2006-0288 DRW:NDHU 2005/12/07 CHKD:HARVEY 2005/12/08 APPR:GCHEN 2005/12/09	QUALITY SYMBOLS	GENERAL TOLERANCES (UNLESS SPECIFIED)	DIMENSION STYLE	SCALE	DESIGN UNITS	THIRD ANGLE PROJECTION
	DESCRIPTION	mm INCH	MM ONLY	METRIC		
	REV	4 PLACES ± --- ± --- 3 PLACES ± --- ± --- 2 PLACES ± 0.2 ± --- 1 PLACE ± --- ± --- ANGULAR ± ---°	DRAWN BY DATE GOH 1995/02/04	TITLE 2.00MM WIRE-BOARD STRAIGHT HEADER		
		DRAFT WHERE APPLICABLE MUST REMAIN WITHIN DIMENSIONS	CHECKED BY DATE	MOLEX INCORPORATED		

APPROVED BY DATE	MATERIAL NO.	DOCUMENT NO.	SHEET NO.
	SEE TABLE	SD-89400-**1*	1 OF 1
THIS DRAWING CONTAINS INFORMATION THAT IS PROPRIETARY TO MOLEX INCORPORATED AND SHOULD NOT BE USED WITHOUT WRITTEN PERMISSION			

9 8 7 6 5 4 3 2 1

X-ON Electronics

Largest Supplier of Electrical and Electronic Components

Click to view similar products for [Headers & Wire Housings](#) category:

Click to view products by [Molex](#) manufacturer:

Other Similar products are found below :

[892-18-020-10-001101](#) [58102-G61-06LF](#) [582553-1](#) [0009485154](#) [009176003701906](#) [0050291907](#) [LY20-4P-DT1-P1E-BR](#) [02.125.8002.8](#)
[609-3404](#) [61062-3](#) [622-0430](#) [622-3653LF](#) [63453-116](#) [636-1030](#) [636-1427](#) [636-3427](#) [636-4007](#) [641938-9](#) [641991-4](#) [644827-2](#) [65817-010LF](#)
[65817-015LF](#) [65863-015LF](#) [66207-023LF](#) [67095-007LF](#) [67601157](#) [68648-049](#) [70.362.1628.0](#) [70-4210](#) [70-4226B](#) [70-4853B](#) [707-5020](#) [707-5028](#) [71.350.2428.0](#) [71918-208LF](#) [71961-016LF](#) [733-134](#) [733-162](#) [754199-000](#) [760-3052](#) [787-8014-00](#) [79531-3000](#) [FCN-360C032-B](#) [FCN-367T-T012/H](#) [FCN-723D010/2](#) [80.063.4001.1](#) [800-90-001-10-001000](#) [800-90-010-10-002000](#) [801-43-002-10-013000](#) [801-43-006-10-002000](#)