

MATERIALS AND FINISHES

SMB JACK FAKRA FOR 1.32 CABLE

BODY, REAR BODY: BRASS
PLATED NICKEL

HOUSING: BRASS
PLATED TIN

CENTER CONTACT: BRASS
PLATED GOLD

INSULATOR : TEFLON

OUTER CASTING: HIGHT TEMPERATURE PLASTIC
KEYING CODE D
COLOR BORDEAUXVIOLET

MCRF W/1.32 CABLE

BODY: PHOSPHOR BRONZE
PLATED GOLD

CENTER CONTACT: PHOSPHOR BRONZE
PLATED GOLD

INSULATOR: PBT

CABLE: 1.32 MM CABLE
OR EQUIVALENT

SHRINK TUBE: VERSAFIT
OR EQUIVALENT

PACKAGING BY POLY BAG

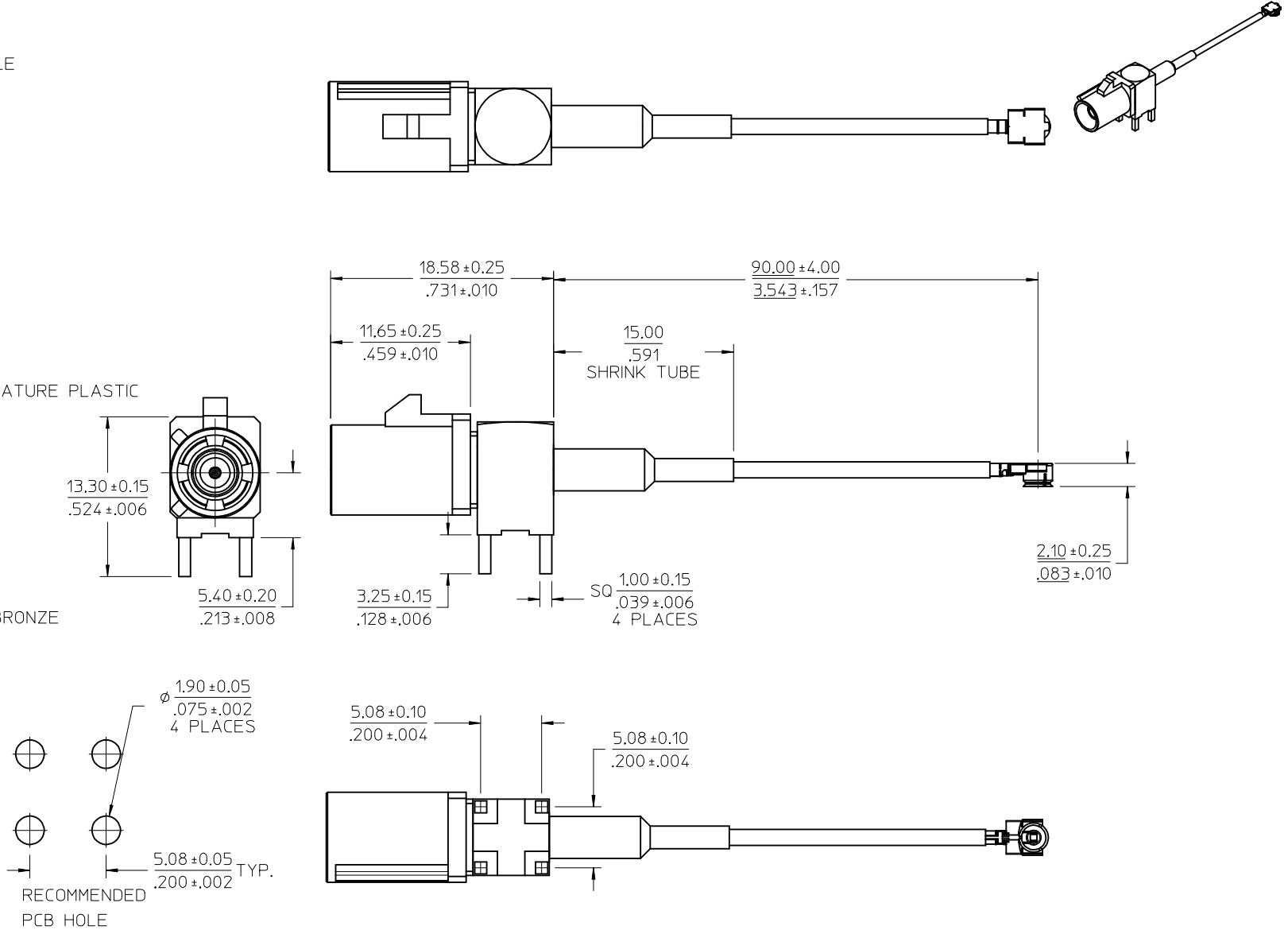

PART # 89762-9030

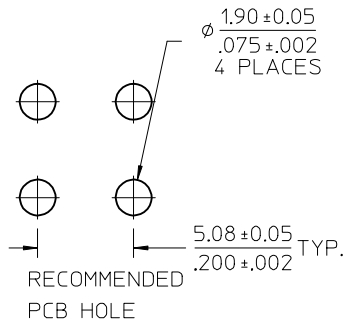

RTM PDR16042232 EC NO: URF2016-0719 DRW: CWE102 2016/04/14 CHKD: APPR: YCHENG 2016/04/26 REV: A	QUALITY SYMBOLS	GENERAL TOLERANCES (UNLESS SPECIFIED)	DIMENSION STYLE	SCALE	DESIGN UNITS	THIRD ANGLE PROJECTION
	▽=0	mm INCH	MM/IN	METRIC		
	▽=0	4 PLACES ± --- ± ---	DRAWN BY DATE	TITLE	DOCUMENT NO.	SHEET NO.
	▽=0	3 PLACES ± --- ± ---	CWE102 2016/04/14			
	2 PLACES ± --- ± ---	CHECKED BY DATE	CA SMB JACK FAKRA TO MCRF W/1.32MM CABLE CA-FAKRA _J/MCRF			
	1 PLACE ± --- ± ---	JOANNE 2016/04/14	molex			
	0 PLACE ± --- ± ---	APPROVED BY DATE	SD-89762-903			
		YCHENG 2016/04/26	1 OF 2			
		MATERIAL NO.	THIS DRAWING CONTAINS INFORMATION THAT IS PROPRIETARY TO MOLEX INCORPORATED AND SHOULD NOT BE USED WITHOUT WRITTEN PERMISSION			
		897629030				

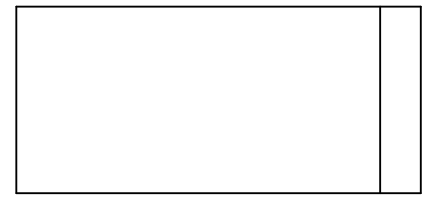
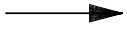
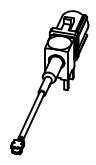

P/N: 89762-9030

25 SET PER BAG

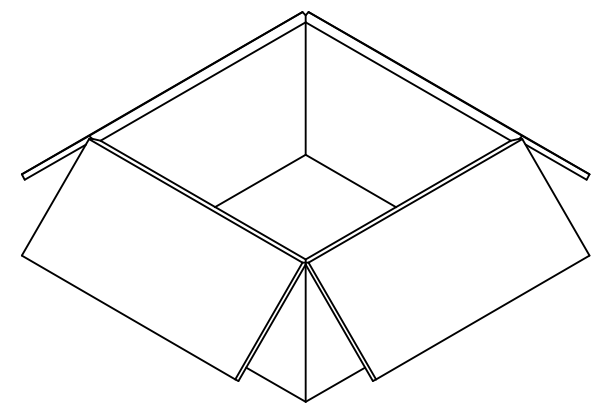
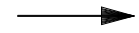
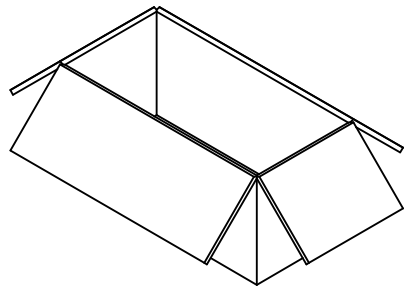

500 SET PER INNER
CARTON BOX
P/N: 96707-0001
367mm*173mm*188mm

1000 SET PER OUTER
CARTON BOX
P/N: 96708-0005
385mm*367mm*206mm

SEE SHEET 1 EC NO: URF2016-0719 DRAWN: CWE102 2016/04/14 CHKD: APPR: YCHENG 2016/04/26	QUALITY SYMBOLS	
REV	DESCRIPTION	

GENERAL TOLERANCES (UNLESS SPECIFIED)	
mm	INCH
4 PLACES ± .005	± .0004
3 PLACES ± .005	± .0004
2 PLACES ± .005	± .0004
1 PLACE ± .005	± .0004
0 PLACE ± .005	± .0004
ANGULAR ± 2 °	
DRAFT WHERE APPLICABLE MUST REMAIN WITHIN DIMENSIONS	

DIMENSION STYLE	
MM/IN	
DRAWN BY	DATE
CWE102	2016/04/14
CHECKED BY	DATE
JOANNE	2016/04/14
APPROVED BY	DATE
YCHENG	2016/04/26
MATERIAL NO.	
SEE SHEET 1	

SCALE	DESIGN UNITS	THIRD ANGLE PROJECTION
	METRIC	
TITLE		
CA SMB JACK FAKRA TO MCRF W/1.32MM CABLE CA-FAKRA_J/MCRF		
molex		
DOCUMENT NO.	SHEET NO.	
SD-89762-903	2 OF 2	

X-ON Electronics

Largest Supplier of Electrical and Electronic Components

Click to view similar products for [RF Cable Assemblies](#) category:

Click to view products by [Molex](#) manufacturer:

Other Similar products are found below :

[73-6352-10](#) [73-6353-3](#) [73-6364-6](#) [MDM-21SH011F](#) [R285001001](#) [R288940004](#) [145111-05-12.00](#) [1661-C-24](#) [1801171170914KE](#)
[24P104C24J1-012](#) [24P104C24P1-018](#) [24P204C24J1-003](#) [FCB-3030-ALT](#) [21117-046](#) [21117-050](#) [24P103C24P2-003](#) [PTWY-24-78](#)
[R284008001](#) [R285001021](#) [R288940003](#) [R288940034](#) [MDM-15PH011F-A174](#) [MDM-21PH006P-A174](#) [4814-BB-24](#) [5260-72](#) [DLP-COAX1](#)
[4814-K-48](#) [115101-09-06.00](#) [MXHT83QE3000](#) [73-6351-25](#) [73-6352-3](#) [73-6353-25](#) [81-6201-1600](#) [GD0BQ0BQ024.0](#) [1-3636-600-5210](#)
[R288940009](#) [MDM-15SH006A](#) [PT82NSMA](#) [73-6353-10](#) [Minibend-9](#) [Minibend-4](#) [BNC TO SMA Cable](#) [MIKROE-274](#) [Minibend-10](#)
[Microbend MTR-11](#) [PT815NN](#) [Minibend-3](#) [Minibend-11](#) [Minibend-6](#) [Minibend-2.5](#)