

EM-90879-001

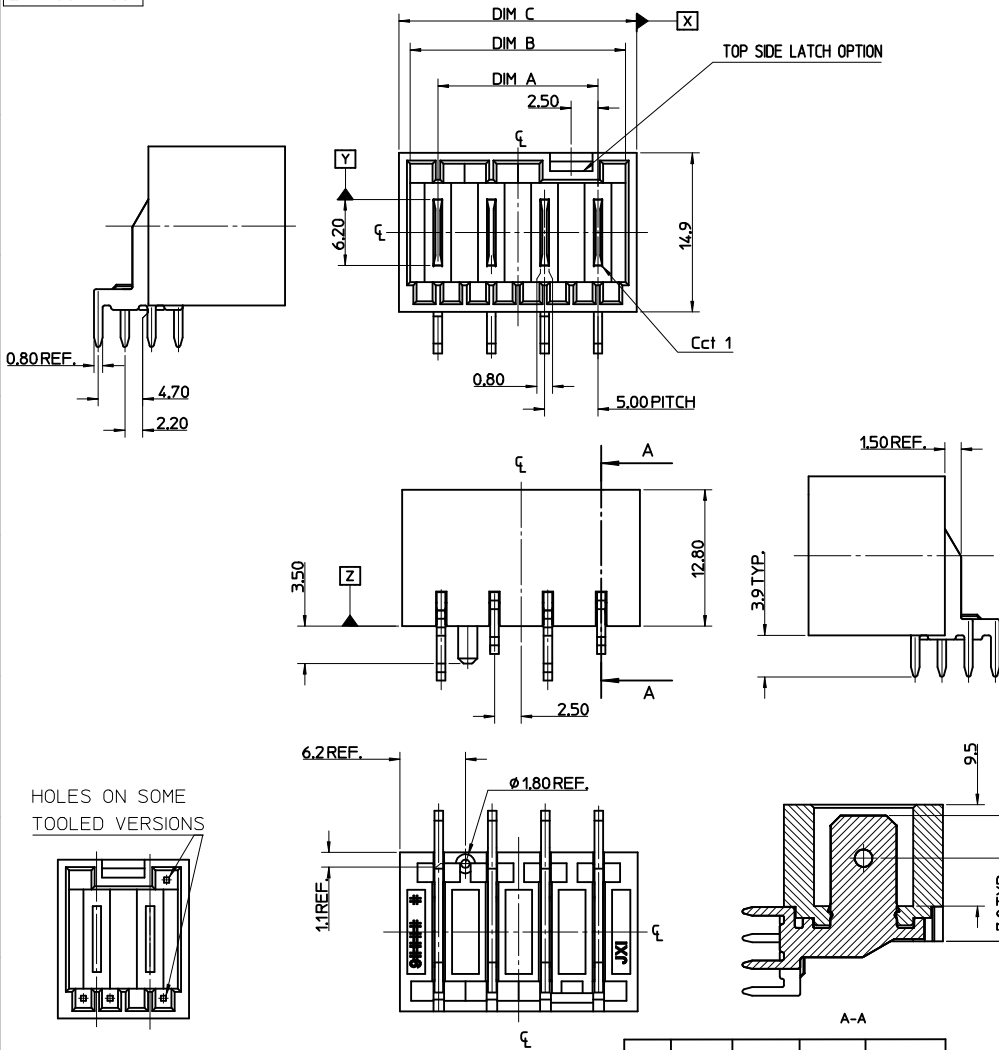

NOTES:

- MATERIAL:
HOUSING: PA 66 , UL94 V-0 750°C GWT NO FLAME
TERMINAL: BRASS 0.80REF. THICK
PLATING: OPTIONAL (SEE CHARTS SHEETS 2-8)
TIN PLATING OPTION : 34µm TIN OVER
127µm NICKEL ALL AREAS.
SELECTIVE SILVER
CONTACT AREA : 24µm SILVER OVER 127µm NICKEL. ALL OTHER AREAS FLASH OF SILVER 0.10µm
- PRODUCT CONFORMS TO SPECIFICATION PS-99020-0037/39
- MATES WITH MOLEX 91338, 90833, 90835, 91777, 91778, 91954, 92000 & 91779
- PARTS PACKED IN TRAYS OPTION C SEE PK-90858-001 FOR PACKAGING INFORMATION
- PLATED THRU HOLE
- RECOMMENDED PCB THICKNESS: 1.5 mm REF

CCT	DIM A	DIM B	DIM C	TOL
2	5.00	10.20	12.30	
3	10.00	15.20	17.30	
4	15.00	20.20	22.30	
5	20.00	25.20	27.30	
6	25.00	30.20	32.30	+/-0.30
7	30.00	35.20	37.30	
8	35.00	40.20	42.30	
9	40.00	45.20	47.30	
10	45.00	50.20	52.30	
11	50.00	55.20	57.30	
12	55.00	60.20	62.30	

RECOMMENDED PCB LAYOUT

P.C.B. POLARISATION OPTION 'A'

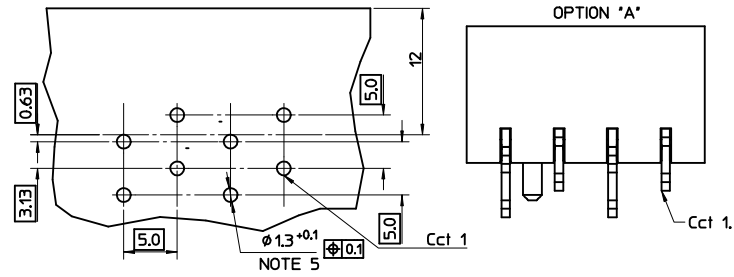

P.C.B. OPTION 'A'

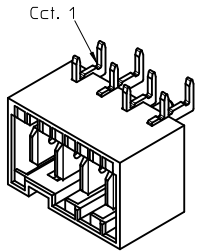
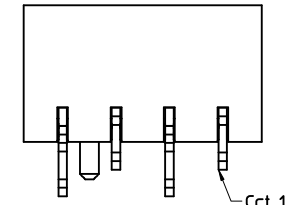

P.C.B. POLARISATION OPTION 'B'
(FOR REVERSE FOOTPRINT)

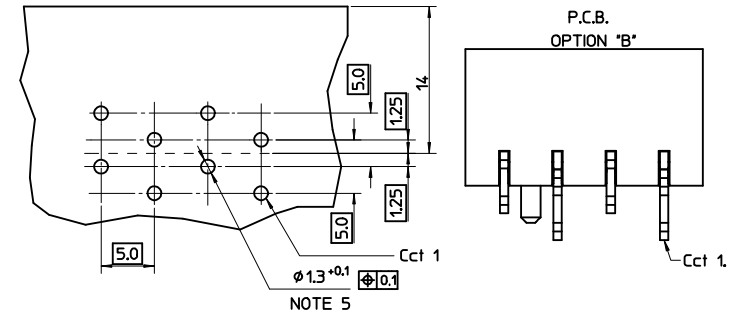

P.C.B. OPTION 'B'

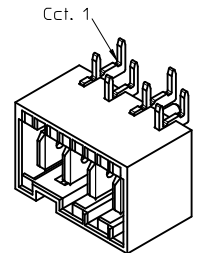
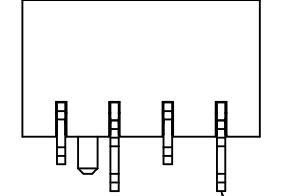

P.C.B. POLARISATION OPTION 'C'
(STRAIGHT PINS)

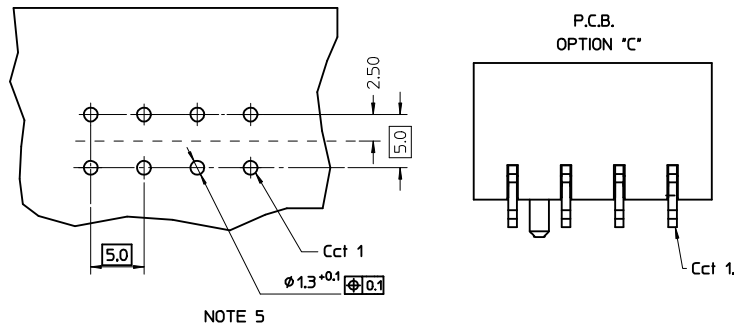

P.C.B. OPTION 'C'

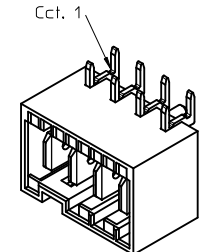
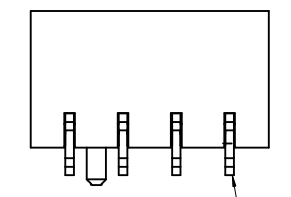

QUALITY SYMBOLS	GENERAL TOLERANCES (UNLESS SPECIFIED)		DIMENSION STYLE		SCALE	DESIGN UNITS	THIRD ANGLE PROJECTION	
	mm	INCH	MM ONLY	DATE				
▽=0	4 PLACES ±---	±---	B. RUTTLE	2006/10/10	1:1	METRIC	RAST 5 R.A. HDR PA 66 HOUSING	
▽=0	3 PLACES ±---	±---	CHECKED BY	DATE				
	2 PLACES ±0.1	±---	T. TOURISH	2006/10/10				
	1 PLACE ±0.2	±---	APPROVED BY	DATE				
	0 PLACE ±	±	B.MAGUIRE	2010/11/01				
	ANGULAR ± 2 °		MATERIAL NO.		DOCUMENT NO.		SHEET NO.	
	DRAFT WHERE APPLICABLE MUST REMAIN WITHIN DIMENSIONS		SEE SHEETS 2-8		SD-93003-001		1 OF 8	
	THIS DRAWING CONTAINS INFORMATION THAT IS PROPRIETARY TO MOLEX INCORPORATED AND SHOULD NOT BE USED WITHOUT WRITTEN PERMISSION							

NON-POTABLE HEADER, LOWER SIDE LATCH OPTION

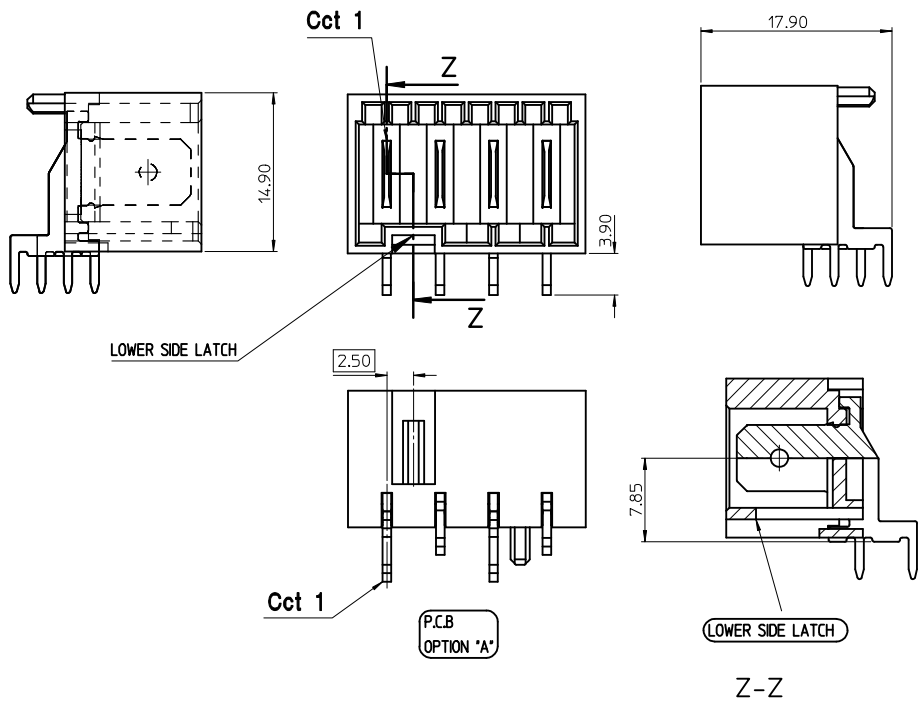

POTABLE HEADER OPTION WITH LOWER SIDE LATCH
P/N 93003-0070 - 2CCT ONLY
CONTACT ENGINEERING FOR LARGER CIRCUIT SIZES

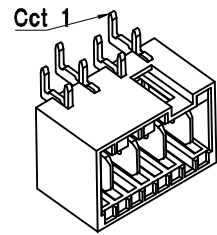
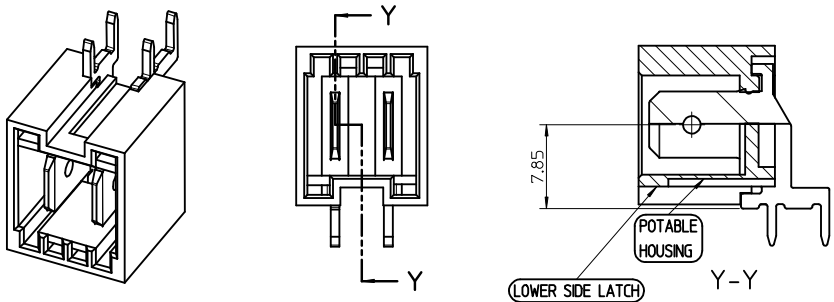

P.C.B
OPTION 'A'

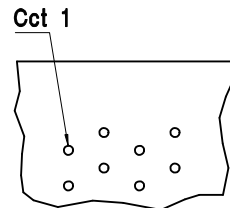
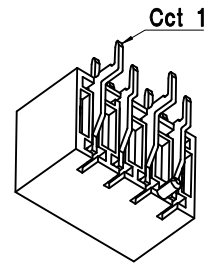

P.C.B. POLARISATION
OPTION "A"
PCB VIEW IS FROM
SOLDER SIDE

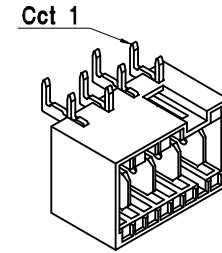

P.C.B
OPTION 'B'

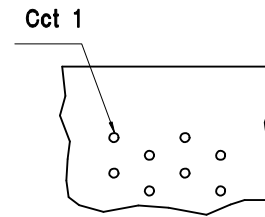
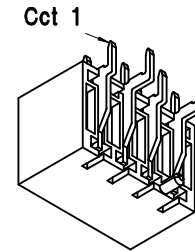

P.C.B. POLARISATION
OPTION "B"
PCB VIEW IS FROM
SOLDER SIDE

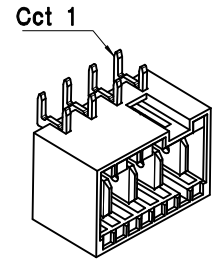

P.C.B
OPTION 'C'

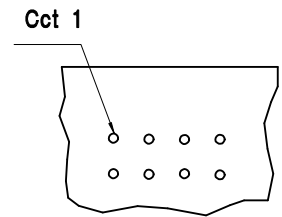
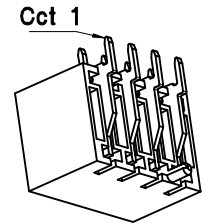

P.C.B. POLARISATION
OPTION "B"
PCB VIEW IS FROM
SOLDER SIDE

SEE SHEET 1 EC NO: IPG2017-0750 DRAWN: ZRAMER 2017/02/07 CHKD: APPR: BRUTTLE 2017/02/24 AR	QUALITY SYMBOLS ▽=0 ▽=0	GENERAL TOLERANCES (UNLESS SPECIFIED) mm INCH 4 PLACES ± --- ± --- 3 PLACES ± --- ± --- 2 PLACES ± 0.1 ± --- 1 PLACE ± 0.2 ± --- 0 PLACE ± ± ANGULAR ± 2 °	DIMENSION STYLE MM ONLY DRAWN BY DATE B. RUTTLE 2006/10/10 CHECKED BY DATE T. TOURISH 2006/10/10 APPROVED BY DATE BMAGUIRE 2010/11/01	SCALE 3:1 DESIGN UNITS METRIC THIRD ANGLE PROJECTION	TITLE RAST 5 R.A. HDR PA 66 HOUSING
	DRAFT WHERE APPLICABLE MUST REMAIN WITHIN DIMENSIONS	MATERIAL NO. SEE CHARTS	DOCUMENT NO. SD-93003-001	SHEET NO. 2 OF 8	
	THIS DRAWING CONTAINS INFORMATION THAT IS PROPRIETARY TO MOLEX INCORPORATED AND SHOULD NOT BE USED WITHOUT WRITTEN PERMISSION				
	SIZE A2				

2 CIRCUIT		SEE CODE DESIGNATION TABLE FOR NUMBERING FORMAT WHEN ADDING NEW PART NUMBERS								P.C.B. POLARISATION OPTION	TOP SIDE LATCH	POTABLE HOUSING		
PART NO. (ITN)	TERM NO. (ITN)	HOUSING NO.	TERMINAL VOID POSITION	UNBLOCKED POSITION KEYS	UNBLOCKED CODING KEYS	LATCH POSITION	CONFIGURATION (SEE NOTES)	LUMBERG K REF	TERM NO. (SILVER)				PART NO. (SILVER)	
93003-0003	91703-0005/8	93002-0002	NONE	1b 2a	01c d20	1/2		K01	91703-0006/9	93003-0499	A	YES	NO	
93003-0046	91703-0005/8	93002-0003	NONE	1a 2b	01c	1/2		K02	91703-0006/9	93003-0498	A	YES		
93003-0026	91703-0005/8	93002-0004	NONE	1b 2b	01c	1/2		K09	91703-0006/9	93003-0488	A	YES		
93003-0018	91703-0005/8	93002-0005	NONE	2a	01c, d20	1/2		K03	91703-0006/9	93003-0495	A	YES		
93003-0021	91703-0005/8	93002-0006	NONE	1b	01c, d20	1/2		K16	91703-0006/9	93003-0492	A	YES		
93003-0022	91703-0005/8	93002-0007	NONE	1a 2b	NONE	1/2		K06	91703-0006/9	93003-0491	A	YES		
93003-0019	91703-0005/8	93002-0008	NONE	1a 2b	d20	1/2		K05	91703-0006/9	93003-0478	A	YES		
93003-0058	91703-0005/8	93002-0009	NONE	2b	NONE	1/2		K11	91703-0006/9	93003-0476	A	YES		
93003-0029	91703-0005/8	93002-0010	NONE	1a 1b	d20	1/2		K13	91703-0006/9	93003-0486	A	YES		
93003-0030	91703-0005/8	93002-0011	NONE	2a 2b	NONE	1/2		K31	91703-0006/9	93003-0485	A	YES		
93003-0059	91703-0005/8	93002-0012	NONE	2b	d20	1/2		K38	91703-0006/9	93003-0475	A	YES		
93003-0060	91703-0005/8	93002-0013	NONE	1a 2a	01c d20	1/2		K44	91703-0006/9	93003-0474	A	YES		
93003-0061	91703-0005/8	93002-0014	NONE	1a 1b	NONE	1/2		K40	91703-0006/9	93003-0473	A	YES		
93003-0020	91703-0005/8	93002-0015	NONE	1a 1b	01c	1/2		K04	91703-0006/9	93003-0493	A	YES		
93003-0062	91703-0005/8	93002-0016	NONE	2b	01c d20	1/2		K15	91703-0006/9	93003-0472	A	YES		
93003-0057	91703-0005/8	93002-0017	NONE	1a	01c d20	1/2		K12	91703-0006/9	93003-0477	A	YES		
93003-0009	91703-0005/8	93002-0018	NONE	1a 2a	01c	1/2		K10	91703-0006/9	93003-0496	A	YES		
93003-0049	91703-0005/8	93002-0019	NONE	ALL	d20	1/2		K34	91703-0006/9	93003-0481	A	YES		
93003-0056	91703-0005/8	93002-0020	NONE	1b 2a 2b	d20	1/2		K07	91703-0006/9	93003-0479	A	YES		
93003-0063	91703-0005/8	93002-0002	NONE	1b 2a	01c d20	1/2		K01	91703-0006/9	93003-0471	B	YES		
93003-0064	91703-0005/8	93002-0024	NONE	ALL	ALL	1/2		K00	91703-0006/9	93003-0470	A	YES		
93003-0065	91703-0005/8	93002-0003	NONE	1a 2b	01c	1/2		K02	91703-0006/9	93003-0469	A	NO		
93003-0066	91703-0005/8	93002-0003	NONE	1a 2b	01c	1/2		K02	91703-0006/9	93003-0468	B	NO		
93003-0067	91703-0005/8	93002-0035	NONE	1b 2a 2b	01c d20	1/2		K78	91703-0006/9	93003-0467	A	YES		
93003-0068	91703-0005/8	93002-0002	NONE	1b 2a	01c d20	1/2		K01	91703-0006/9	93003-0466	A	NO		
93003-0069	91703-0005/8	93002-0005	NONE	2a	01c d20	1/2		K03	91703-0006/9	93003-0465	A	NO		
93003-0070	91703-0005/8	93228-0008	NONE	1a 2b	NONE	1/2		---	91703-0006/9	93003-0464	A	NO		YES
93003-0071	91703-0005	93002-0028	NONE	1a 2a 2b	01c d20	1/2		---	91703-0006	93003-0463	C	YES		NO

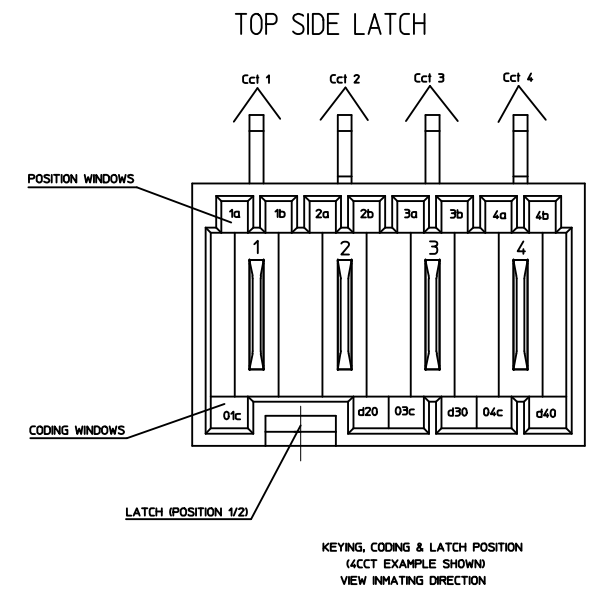
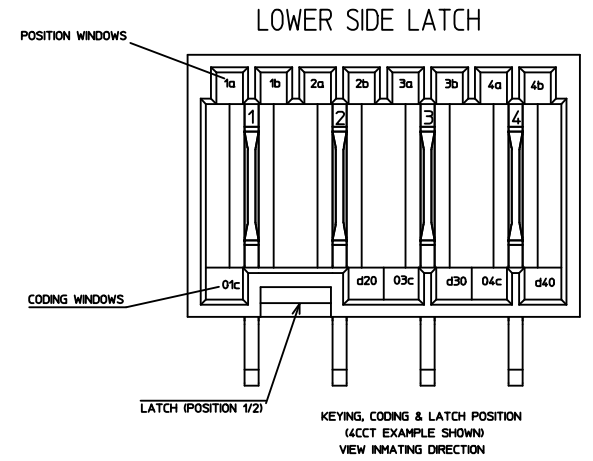

SEE SHEET 1 SEC NO: IFC2017-0750 DRAWN:ZGRAMER CHKD: APP:R:BRITTLE	2017/02/07	2017/02/24	QUALITY SYMBOLS	GENERAL TOLERANCES (UNLESS SPECIFIED)	DIMENSION STYLE	SCALE	DESIGN UNITS	THIRD ANGLE PROJECTION
			▽=0	m.m INCH	MM ONLY	7:1	METRIC	
			▽=0	4 PLACES ± --- ± ---	DRAWN BY DATE			
				3 PLACES ± --- ± ---	B. RUTILE 2006/10/10			
			2 PLACES ± 0.1 ± ---	CHECKED BY DATE				RAST 5 R.A. HDR PA 66 HOUSING
			1 PLACE ± 0.2 ± ---	T. TOURISH 2006/10/10				
			0 PLACE ± ±	APPROVED BY DATE				molex
			ANGULAR ± 2 °	B.MAGUIRE 2010/11/01				
			DRAFT WHERE APPLICABLE MUST REMAIN WITHIN DIMENSIONS	SEE CHARTS	MATERIAL NO.	DOCUMENT NO.		SHEET NO.
				SIZE 1		SD-93003-001		3 OF 8
					THIS DRAWING CONTAINS INFORMATION THAT IS PROPRIETARY TO MOLEX INCORPORATED AND SHOULD NOT BE USED WITHOUT WRITTEN PERMISSION			

3 CIRCUIT												P.C.B. POLARISATION OPTION	TOP SIDE LATCH
SEE CODE DESIGNATION TABLE FOR NUMBERING FORMAT WHEN ADDING NEW PART NUMBERS													
PART NO. (TIN)	TERM NO. (TIN)	MOLEX HOUSING NO.	TERMINAL VOID POSITION	UNLOCKED POSITION KEYS	UNLOCKED CODING KEYS	LATCH POSITION	CONFIGURATION (SEE NOTES)	LUMBERG K REF.	TERM NO. (SILVER)	PART NO. (SILVER)			
93003-0502	91703-0005/8	93002-1000	NONE	1b	01c, d20	1/2		K01	91703-0006/9	93003-1249	A	YES	
93003-0508	91703-0005/8	93002-1001	NONE	1a	03c	1/2		K04	91703-0006/9	93003-1248	A	YES	
93003-0528	91703-0005/8	93002-1002	NONE	1a 1b	d30	1/2		K05	91703-0006/9	93003-1247	A	YES	
93003-0512	91703-0005/8	93002-1003	NONE	1a 3b	01c	1/2		K06	91703-0006/9	93003-1246	A	YES	
93003-0513	91703-0005/8	93002-1004	NONE	1b	d20 03c	1/2		K09	91703-0006/9	93003-1245	A	YES	
93003-0529	91703-0005/8	93002-1005	NONE	1b 2a 2b	d30	1/2		K33	91703-0006/9	93003-1244	A	YES	
93003-0530	91703-0005/8	93002-1006	NONE	2b	d20	1/2		K56	91703-0006/9	93003-1243	A	YES	
93003-0526	91703-0005/8	93002-1007	NONE	ALL	d10 d30	2/3		K38	91703-0006/9	93003-1242	A	YES	
93003-0527	91703-0005/8	93002-1008	NONE	ALL	d20	1/2		K40	91703-0006/9	93003-1241	A	YES	
93003-0531	91703-0005/8	93002-1014	NONE	ALL	ALL	1/2		K00	91703-0006/9	93003-1240	A	YES	
93003-0532	91703-0005/8	93002-1020	NONE	3b	01c d30	1/2		K37	91703-0006/9	93003-1239	A	YES	
93003-0533	91703-0005/8	93002-1021	NONE	1b 3a	01c	1/2		K03	91703-0006/9	93003-1238	A	NO	
93003-0534	91703-0005/8	93002-1000	CCT 2	1b	01c d20	1/2		K--	91703-0006/9	93003-1237	A	YES	
93003-0535	91703-0005/8	93002-1024	CCT 2	3b	01c 03c	1/2		K--	91703-0006/9	93003-1236	A	YES	
93003-0536	91703-0005	93002-1011	CCT 2	3b	01c d30	2/3		K--	91703-0006	93003-1235	C	YES	
93003-0537	91703-0005	93002-1000	NONE	1b	01c d20	1/2		K--	91703-0006	93003-1234	C	YES	
93003-0538	91703-0005	93002-1036	NONE	NONE	d10 02c d30	2/3		K--	91703-0006	93003-1233	C	YES	
93003-0539	91703-0005/8	93002-1000	NONE	1b	01c d20	1/2		K01	91703-0006/9	93003-1232	A	NO	

4 CIRCUIT												P.C.B. POLARISATION OPTION	TOP SIDE LATCH
SEE CODE DESIGNATION TABLE FOR NUMBERING FORMAT WHEN ADDING NEW PART NUMBERS													
PART NO. (TIN)	TERM NO. (TIN)	MOLEX HOUSING NO.	TERMINAL VOID POSITION	UNLOCKED POSITION KEYS	UNLOCKED CODING KEYS	LATCH POSITION	CONFIGURATION (SEE NOTES)	LUMBERG K REF.	TERM NO. (SILVER)	PART NO. (SILVER)			
93003-1254	91703-0005/8	93002-2000	NONE	1b	03c d40	1/2 3/4		K01	91703-0006/9	93003-1999	A	YES	
93003-1264	91703-0005/8	93002-2001	NONE	1a 4b	d40	1/2 3/4		K03	91703-0006/9	93003-1997	A	YES	
93003-1265	91703-0005/8	93002-2002	NONE	2a 4b	d20	1/2 3/4		K07	91703-0006/9	93003-1996	A	YES	
93003-1267	91703-0005/8	93002-2003	NONE	1b 2a 3a 4b	01c d40	1/2 3/4		K37	91703-0006/9	93003-1994	A	YES	
93003-1278	91703-0005/8	93002-2004	NONE	1a 2b 4b	01c 03c d40	1/2 3/4		K44	91703-0006/9	93003-1988	A	YES	
93003-1279	91703-0005/8	93002-2005	NONE	1a 3a 3b	01c d20 d40	1/2 3/4		K32	91703-0006/9	93003-1987	A	YES	
93003-1280	91703-0005/8	93002-2006	NONE	1b 2a 4b	01c d20 03c	1/2 3/4		K61	91703-0006/9	93003-1986	A	YES	
93003-1281	91703-0005/8	93002-2007	NONE	1a 3a	d40	1/2 3/4		K06	91703-0006/9	93003-1985	A	YES	
93003-1282	91703-0005/8	93002-2008	NONE	1a 2b 3b 4a	01c 03c d40	1/2 3/4		K65	91703-0006/9	93003-1984	A	YES	
93003-1266	91703-0005/8	93002-2009	NONE	2a 4b	d20 03c	1/2 3/4		K30	91703-0006/9	93003-1995	A	YES	
93003-1276	91703-0005/8	93002-2010	NONE	3b	d30	2/3		K04	91703-0006/9	93003-1989	A	YES	
93003-1283	91703-0005/8	93002-2018	NONE	ALL	ALL	1/2 3/4		K00	91703-0006/9	93003-1983	A	YES	
93003-1284	91703-0005/8	93002-2022	NONE	1b	03c	1/2 3/4		N/A	91703-0006/9	93003-1982	A	YES	
93003-1285	91703-0005/8	93002-2024	NONE	ALL	03c, d40	1/2 3/4		N/A	91703-0006/9	93003-1981	A	YES	
93003-1286	91703-0005/8	93002-2000	NONE	1b	03c, d40	1/2 3/4		K01	91703-0006/9	93003-1980	B	YES	
93003-1287	91703-0005/8	93002-2025	CCT 2	1a 3a 3b 4a 4b	03c, d40	1/2 3/4		---	91703-0006/9	93003-1979	A	YES	
93003-1288	91703-0005/8	93002-2000	NONE	1b	03c, d40	1/2 3/4		K01	91703-0006/9	93003-1978	A	NO	
93003-1289	91703-0005/8	93002-2032	NONE	1a 2b 3b 4a	d20 03c d40	1/2 3/4		K86	91703-0006/9	93003-1977	A	YES	
93003-1290	91703-0005/8	93002-2000	3	1b	03c d40	1/2 3/4		K01	91703-0006/9	93003-1976	A	YES	
93003-1291	91703-0005/8	93002-2018	NONE	ALL	ALL	1/2 3/4		K00	91703-0006/9	93003-1975	A	NO	
93003-1292	91703-0005/8	93002-2043	NONE	2a 2b 3b 4b	01c d40	1/2 3/4		---	91703-0006/9	93003-1974	A	YES	
93003-1293	91703-0005/8	93002-2045	NONE	1b 2b 4a 4b	d20 03c	1/2 3/4		K296	91703-0006/9	93003-1973	A	NO	
93003-1294	91703-0005	93002-2000	NONE	1b	03c d40	1/2 3/4		K**	91703-0006	93003-1972	C	YES	
93003-1295	91703-0005/8	93002-2000	NONE	1b	03c d40	1/2 3/4		K**	91703-0006/9	93003-1971	A	YES	

SEE SHEET 1 SEC NO: 1P02017-0750 DRAWN BY: DRWINZGRANER CHKD: AR APPR: BRUTLE 2017/02/24	QUALITY SYMBOLS 	GENERAL TOLERANCES (UNLESS SPECIFIED) mm INCH 4 PLACES ± --- ± --- 3 PLACES ± --- ± --- 2 PLACES ± 0.1 ± --- 1 PLACE ± 0.2 ± --- 0 PLACE ± ±	DIMENSION STYLE MM ONLY	SCALE 1:1	DESIGN UNITS METRIC	THIRD ANGLE PROJECTION
	DRAWN BY: B. RUTLE DATE: 2006/10/10	CHECKED BY: T. TOURISH DATE: 2006/10/10	APPROVED BY: BMAGUIRE DATE: 2010/11/01	MATERIAL NO.	DOCUMENT NO.	SHEET NO.
	DRAFT WHERE APPLICABLE MUST REMAIN WITHIN DIMENSIONS	SEE CHARTS	ANGULAR ± 2 °	THIS DRAWING CONTAINS INFORMATION THAT IS PROPRIETARY TO MOLEX INCORPORATED AND SHOULD NOT BE USED WITHOUT WRITTEN PERMISSION	RAST 5 R.A. HDR PA 66 HOUSING	SD-93003-001 4 OF 8
	RAST 5 R.A. HDR PA 66 HOUSING 					

5 CIRCUIT												SEE CODE DESIGNATION TABLE FOR NUMBERING FORMAT WHEN ADDING NEW PART NUMBERS		P.C.B. POLARISATION OPTION	TOP SIDE LATCH
PART NO. (TIN)	TERM NO. (TIN)	MOLEX HOUSING NO.	TERMINAL VOID POSITION	UNLOCKED POSITION KEYS	UNLOCKED CODING KEYS	LATCH POSITION	CONFIGURATION (SEE NOTES)	LUMBERG K REF	TERM NO. (SILVER)	PART NO. (SILVER)					
93003-2000	91703-0005/8	93002-3000	NONE	1a 5b	01c d30	1/2 2/3		K01	91703-0006/9	93003-2749	A	YES			
93003-2001	91703-0005/8	93002-3001	NONE	1a 3a	01c d30	1/2 4/5		K30	91703-0006/9	93003-2748	A	YES			
93003-2002	91703-0005/8	93002-3002	NONE	1a 5b	01c d20 03c d50	1/2 3/4		K31	91703-0006/9	93003-2747	A	YES			
93003-2003	91703-0005/8	93002-3003	NONE	1b 2a 3b 5a	01c 03c	1/2 3/4		K35	91703-0006/9	93003-2746	A	YES			
93003-2023	91703-0005/8	93002-3004	NONE	1a 2a 2b 4b 5b	01c d30 04c d50	1/2 2/3 4/5		K36	91703-0006/9	93003-2732	A	YES			
93003-2024	91703-0005/8	93002-3005	NONE	2a	01c d50	2/3 4/5		K43	91703-0006/9	93003-2731	A	YES			
93003-2025	91703-0005/8	93002-3006	NONE	2a 4b	01c d20 d40	1/2 3/4		K44	91703-0006/9	93003-2730	A	YES			
93003-2026	91703-0005/8	93002-3007	NONE	2b	d20	1/2 4/5		K02	91703-0006/9	93003-2729	A	YES			
93003-2027	91703-0005/8	93002-3008	NONE	4b 5a	01c d30 04c d50	1/2 4/5		K45	91703-0006/9	93003-2728	A	YES			
93003-2028	91703-0005/8	93002-3009	NONE	NONE	01c d40	1/2 3/4		K46	91703-0006/9	93003-2727	A	YES			
93003-2029	91703-0005/8	93002-3010	NONE	1a 4b	d30	1/2 4/5		K04	91703-0006/9	93003-2726	A	YES			
93003-2030	91703-0005/8	93002-3011	NONE	1a 5b	d20 d40	1/2 3/4		K77	91703-0006/9	93003-2725	A	YES			
93003-2005	91703-0005/8	93002-3012	NONE	1b 2b 4a	d20 d30 d50	1/2 4/5		K40	91703-0006/9	93003-2744	A	YES			
93003-2016	91703-0005/8	93002-3013	NONE	3b 4a 5b	01c d30 d50	2/3 4/5		K47	91703-0006/9	93003-2738	A	YES			
93003-2018	91703-0005/8	93002-3014	NONE	1a 4b	01c	1/2 3/4		K48	91703-0006/9	93003-2736	A	YES			
93003-2020	91703-0005/8	93002-3015	NONE	1a 5b	d30 04c	2/3		K50	91703-0006/9	93003-2734	A	YES			
93003-2021	91703-0005/8	93002-3016	NONE	1b 2a 4a	01c 04c d50	1/2 4/5		K51	91703-0006/9	93003-2733	A	YES			
93003-2022	91703-0005/8	93002-3017	NONE	2b 3b 4a	01c d20 d40	1/2 3/4		K52	91703-0006/9	93003-2735	A	YES			
93003-2031	91703-005/8	93002-3024	NONE	ALL	ALL	1/2 3/4		K00	91703-0006/9	93003-2724	A	YES			
93003-2032	91703-005/8	93002-3025	CCT 3	2b	d30	1/2 4/5		N/A	91703-0006/9	93003-2723	B	YES			
93003-2033	91703-005/8	93002-3027	CCT 2	2b	01c d20 03c d30 04c d50	1/2 4/5		N/A	91703-0006/9	93003-2722	A	YES			
93003-2034	91703-005/8	93002-3028	CCT 3	2b	01c d20 03c 04c d50	1/2 4/5		N/A	91703-0006/9	93003-2721	A	YES			

6 CIRCUIT												SEE CODE DESIGNATION TABLE FOR NUMBERING FORMAT WHEN ADDING NEW PART NUMBERS		P.C.B. POLARISATION OPTION	TOP SIDE LATCH
PART NO. (TIN)	TERM NO. (TIN)	MOLEX HOUSING NO.	TERMINAL VOID POSITION	UNLOCKED POSITION KEYS	UNLOCKED CODING KEYS	LATCH POSITION	CONFIGURATION (SEE NOTES)	LUMBERG K REF	TERM NO. (SILVER)	PART NO. (SILVER)					
93003-2753	91703-0005/8	93002-4000	NONE	1b	03c d60	1/2 4/5		K01	91703-0006/9	93003-3499	A	YES			
93003-2754	91703-0005/8	93002-4001	NONE	1a 3b 4b	01c d50 06c	1/2 4/5		K30	91703-0006/9	93003-3498	A	YES			
93003-2755	91703-0005/8	93002-4002	NONE	1a 1b 2b 3a 3b 4b	d30 04c d50	1/2 2/3 4/5		K37	91703-0006/9	93003-3497	A	YES			
93003-2756	91703-0005/8	93002-4003	NONE	1a 1b 4a 4b	d10 d50	2/3 4/5		K39	91703-0006/9	93003-3496	A	YES			
93003-2757	91703-0005/8	93002-4004	NONE	2a 4b 5a 6a	d20 03c 05c	1/2 3/4 5/6		K42	91703-0006/9	93003-3495	A	YES			
93003-2758	91703-0005/8	93002-4005	NONE	1a 2b 3a 3b 5b 6b	01c d40 d60	1/2 3/4 5/6		K43	91703-0006/9	93003-3494	A	YES			
93003-2759	91703-0005/8	93002-4006	NONE	1b 2a 3a 4b 5a 5b 6b	01c 03c d60	1/2 3/4 5/6		K44	91703-0006/9	93003-3493	A	YES			
93003-2760	91703-0005/8	93002-4007	NONE	2b	d20 d60	1/2 5/6		K46	91703-0006/9	93003-3492	A	YES			
93003-2761	91703-0005/8	93002-4008	NONE	2b 3b 4a	01c d50 06c	1/2 4/5		K36	91703-0006/9	93003-3491	A	YES			
93003-2762	91703-0005/8	93002-4009	NONE	1b 4b	d20 03c d50 06c	1/2 4/5		K58	91703-0006/9	93003-3486	A	YES			
93003-2764	91703-0005/8	93002-4010	NONE	1a 2b 3b 4a 6b	01c 03c d40 05c d60	1/2 3/4 5/6		K59	91703-0006/9	93003-3485	A	YES			
93003-2765	91703-0005/8	93002-4011	NONE	1a 2b 4a 6b	01c d40	1/2 3/4 5/6		K62	91703-0006/9	93003-3484	A	YES			
93003-2763	91703-0005/8	93002-4012	NONE	1b 2b 3b	01c 05c d60	1/2 3/4 5/6		K51	91703-0006/9	93003-3490	A	YES			
93003-2766	91703-0005/8	93002-4013	NONE	1b	d20 03c	1/2 4/5		K55	91703-0006/9	93003-3489	A	YES			
93003-2767	91703-0005/8	93002-4014	NONE	1b 2a 3a 5a 5b	01c d20 03c d40 d60	1/2 3/4 5/6		K56	91703-0006/9	93003-3488	A	YES			
93003-2771	91703-0005/8	93002-4015	NONE	1a 3a 3b 5b 6a	01c d20 240 05c d60	1/2 3/4 5/6		K60	91703-0006/9	93003-3487	A	YES			
93003-2772	91703-0005/8	93002-4018	NONE	ALL	ALL	1/2 4/5		K00	91703-0006/9	93003-3483	A	YES			
93003-2773	91703-0005/8	93002-4024	NONE	1b 2a 2b 3a 6a 6b	d20 04c d60	1/2 5/6		K29	91703-0006/9	93003-3482	A	No			

SEE SHEET 1 SEC NO: 1P02017-0750 DRWNGZ: CARMER CHKD: APPR: BRUTTLE 2017/02/24	QUALITY SYMBOLS 	GENERAL TOLERANCES (UNLESS SPECIFIED)		DIMENSION STYLE MM ONLY		SCALE 1:1	DESIGN UNITS METRIC	THIRD ANGLE PROJECTION	
		4 PLACES ± --- ± --- 3 PLACES ± --- ± --- 2 PLACES ± 0.1 ± --- 1 PLACE ± 0.2 ± --- 0 PLACE ± ±	mm INCH ± --- ± --- ± --- ± --- ± --- ± --- ± ±	DRAWN BY B. RUTTLE	DATE 2006/10/10	TITLE RAST 5 R.A. HDR PA 66 HOUSING			
		DRAFT WHERE APPLICABLE MUST REMAIN WITHIN DIMENSIONS		CHECKED BY I. TOURISH	DATE 2006/10/10	molex			
		ANGULAR ± 2 °		APPROVED BY BMAGUIRE	DATE 2010/11/01	MATERIAL NO. SEE CHARTS		DOCUMENT NO. SD-93003-001	SHEET NO. 5 OF 8

THIS DRAWING CONTAINS INFORMATION THAT IS PROPRIETARY TO MOLEX
INCORPORATED AND SHOULD NOT BE USED WITHOUT WRITTEN PERMISSION

7 CIRCUIT										SEE CODE DESIGNATION TABLE FOR NUMBERING FORMAT WHEN ADDING NEW PART NUMBERS			P.C.B. POLARISATION OPTION	TOP SIDE LATCH
PART NO. (TIN)	TERM NO. (TIN)	MOLEX HOUSING NO.	TERMINAL VOID POSITION	UNBLOCKED POSITION KEYS	UNBLOCKED CODING KEYS	LATCH POSITION	CONFIGURATION (SEE NOTES)	LUMBERG K REF	TERM NO. (SILVER)	PART NO. (SILVER)				
93003-3500	91703-0005/8	93002-5000	NONE	NONE	03c d40 07c	1/2 5/6		K01	91703-0006/9	93003-4220	A	YES		
93003-3512	91703-0005/8	93002-5001	NONE	3a 4a	d30 d70	1/2 5/6		K30	91703-0006/9	93003-4248	A	YES		
93003-3504	91703-0005/8	93002-5002	NONE	2b	d20 d60	1/2 5/6		K32	91703-0006/9	93003-4247	A	YES		
93003-3513	91703-0005/8	93002-5003	NONE	1a 1b 3a 4b 5a	01c 07c	1/2 3/4 5/6		K40	91703-0006/9	93003-4240	A	YES		
93003-3514	91703-0005/8	93002-5004	NONE	2a	01c d50	2/3 4/5		K41	91703-0006/9	93003-4239	A	YES		
93003-3515	91703-0005/8	93002-5005	NONE	7b	01c d40 d70	1/2 3/4 6/7		K43	91703-0006/9	93003-4238	A	YES		
93003-3516	91703-0005/8	93002-5006	NONE	1b	03c d60	1/2 4/5		K31	91703-0006/9	93003-4237	A	YES		
93003-3517	91703-0005/8	93002-5007	NONE	1a 3a 4b 7b	01c d20 03c d6c	1/2 3/4 6/7		K45	91703-0006/9	93003-4236	A	YES		
93003-3518	91703-0005/8	93002-5008	NONE	1b 7a	02c d50	2/3 6/7		K48	91703-0006/9	93003-4235	A	YES		
93003-3519	91703-0005/8	93002-5009	NONE	1a 2b 3a 4b 6a	d20 03c d40 d50 d70	1/2 3/4 6/7		K51	91703-0006/9	93003-4234	A	YES		
93003-3520	91703-0005/8	93002-5010	NONE	1b 6a	d20 03c d50 d70	1/2 3/4 6/7		K69	91703-0006/9	93003-4233	A	YES		
93003-3505	91703-0005/8	93002-5011	NONE	1b 2a 5a 5b 7b	d20 d50 06c d70	1/2 4/5 6/7		K34	91703-0006/9	93003-4246	A	YES		
93003-3506	91703-0005/8	93002-5012	NONE	2b	d20 07c	1/2 3/4 5/6		K35	91703-0006/9	93003-4245	A	YES		
93003-3507	91703-0005/8	93002-5013	NONE	2a 2b 4b 5b 6a	d20 03c d40 d60	1/2 3/4 5/6		K38	91703-0006/9	93003-4244	A	YES		
93003-3510	91703-0005/8	93002-5014	NONE	2b 4a 4b 5b 6a	01c d20 d40 d60	1/2 3/4 5/6		K42	91703-0006/9	93003-4241	A	YES		
93003-3521	91703-0005/8	93002-5016	NONE	ALL	ALL	1/2 5/6		K00	91703-0006/9	93003-4232	A	YES		
93003-3522	91703-0005/8	93002-5019	CCT 8	ALL	03c d40 07c	1/2 5/6		---	91703-0006/9	93003-4231	A	YES		
93003-3523	91703-0005/8	93002-5000	NONE	NONE	03c d40 07c	1/2 5/6		K01	91703-0006/9	93003-4230	A	NO		
93003-3524	91703-0005/8	93002-5020	NONE	ALL	ALL	1/2 4/5 6/7		K101	91703-0006/9	93003-4229	A	YES		
93003-3525	91703-0005/8	93002-5019	NONE	ALL	03c d40 07c	1/2 5/6		---	91703-0006/9	93003-4228	A	YES		
93003-3526	91703-0005/8	93002-5017	CCT 4, 5, 6	2a 3b 4b 5a 6a 6b 7a	01c d30 04c 06c d60 d70	1/2 4/5		---	91703-0006/9	93003-4227	A	YES		
93003-3527	91703-0005/8	93002-5017	CCT 4	2a 3b 4b 5a 6a 6b 7a	01c d30 04c 06c d60 d70	1/2 4/5		---	91703-0006/9	93003-4226	A	YES		
93003-3529	91703-0005/8	93002-5024	NONE	3a 4b 7a	ALL	1/2 5/6		---	91703-0006/9	93003-4225	A	YES		

8 CIRCUIT										SEE CODE DESIGNATION TABLE FOR NUMBERING FORMAT WHEN ADDING NEW PART NUMBERS			P.C.B. POLARISATION OPTION
PART NO. (TIN)	TERM NO. (TIN)	MOLEX HOUSING NO.	TERMINAL VOID POSITION	UNBLOCKED POSITION KEYS	UNBLOCKED CODING KEYS	LATCH POSITION	CONFIGURATION (SEE NOTES)	LUMBERG K REF	TERM NO. (SILVER)	PART NO. (SILVER)			
93003-4252	91703-0005/8	93002-6000	NONE	4a 6b	03c d60	1/2 3/4 5/6 7/8		K30	91703-0006/9	93003-4998	A		
93003-4253	91703-0005/8	93002-6001	NONE	1a 2a 3a 3b 6a 7a 7b 8b	01c 05c d60	1/2 3/4 5/6 7/8		K33	91703-0006/9	93003-4997	A		
93003-4254	91703-0005/8	93002-6002	NONE	2b 3b 4b 5a 5b 7a 8b	01c d60 d80	1/2 4/5 7/8		K41	91703-0006/9	93003-4996	A		
93003-4255	91703-0005/8	93002-6003	NONE	1b 4b 7b 8b	01c d20 04c d50 07c	1/2 4/5 7/8		K45	91703-0006/9	93003-4995	A		
93003-4256	91703-0005/8	93002-6004	NONE	1a 1b 3b 5a 6b 7a 8b	01c 03c d40 d60	1/2 3/4 5/6 7/8		K46	91703-0006/9	93003-4993	A		
93003-4257	91703-0005/8	93002-6005	NONE	1b 5a 6b 8a	03c d40 05c 07c d80	1/2 3/4 5/6 7/8		K48	91703-0006/9	93003-4992	A		
93003-4259	91703-0005/8	93002-6006	NONE	8b	02c d30 07c	2/3 7/8			91703-0006/9	93003-4991	A		
93003-4258	91703-0005/8	93002-6007	NONE	1a 4b 5b 6a 8b	d40 d60 07c d80	1/2 3/4 5/6 7/8		K44	91703-0006/9	93003-4994	A		
93003-4263	91703-0005/8	93002-6008	NONE	8b	02c d30	2/3		K49	91703-0006/9	93003-4990	A		
93003-4264	91703-0005/8	93002-6006	NONE	8b	02c d30 07c	2/3 7/8			91703-0006/9	93002-4989	A		

SEE SHEET 1 SEC NO: IP2017-0750 DRAWING: GRAMER 2017/02/07 CHKD: AR APPR: BRITTLE REV:	QUALITY SYMBOLS ▽=0 ▽=0	GENERAL TOLERANCES (UNLESS SPECIFIED) mm INCH 4 PLACES ± --- ± --- 3 PLACES ± --- ± --- 2 PLACES ± 0.1 ± --- 1 PLACE ± 0.2 ± --- 0 PLACE ± ±	DIMENSION STYLE MM ONLY	SCALE 1:1	DESIGN UNITS METRIC	THIRD ANGLE PROJECTION
	DRAWN BY DATE B. RUTLE 2006/10/10	CHECKED BY DATE T. TOURISH 2006/10/10	APPROVED BY DATE BMAGUIRE 2010/11/01	MATERIAL NO.	DOCUMENT NO. SD-93003-001	SHEET NO. 6 OF 8
	DRAFT WHERE APPLICABLE MUST REMAIN WITHIN DIMENSIONS	SEE CHARTS	THIS DRAWING CONTAINS INFORMATION THAT IS PROPRIETARY TO MOLEX INCORPORATED AND SHOULD NOT BE USED WITHOUT WRITTEN PERMISSION			
	RAST 5 R.A. HDR PA 66 HOUSING					

9 CIRCUIT											SEE CODE DESIGNATION TABLE FOR NUMBERING FORMAT WHEN ADDING NEW PART NUMBERS				P.C.B. POLARISATION OPTION
PART NO. (ITN)	TERM NO. (ITN)	MOLEX HOUSING NO.	TERMINAL VOID POSITION	UNBLOCKED POSITION KEYS	UNBLOCKED CODING KEYS	LATCH POSITION	CONFIGURATION (SEE NOTES)	LUMBERG K REF.	TERM NO. (SILVER)	PART NO. (SILVER)					
93003-5002	91703-0005/8	93002-7000	NONE	1a 2a 2b 3a 3b 6a 7a 8a 9b	d20 03c d40 d50 d90	1/2 3/4 6/7 7/8 8/9		K30	91703-0006/9	93003-5997	A				
93003-5003	91703-0005/8	93002-7001	NONE	1b 2a 3b 5a 6a 7b 8a 8b	01c 03c d70 08c	1/2 3/4 6/7 8/9		K31	91703-0006/9	93003-5996	A				
93003-5004	91703-0005/8	93002-7002	NONE	1b 2a 3a 5a 6a 7b 8b	01c 03c d70 08c d90	1/2 3/4 6/7 8/9		K32	91703-0006/9	93003-5995	A				
93003-5005	91703-0005/8	93002-7003	NONE	1a 1b 3a 4b 5a 6b 7a	01c d40 09c	1/2 3/4 5/6 7/8		K37	91703-0006/9	93003-5994	A				
93003-5006	91703-0005/8	93002-7004	NONE	1b 5a 8a 9a	03c d40 d60 08c	1/2 3/4 5/6 8/9		K38	91703-0006/9	93003-5993	A				
93003-5007	91703-0005/8	93002-7005	NONE	2a 4b 5a 6b 6b 7a 9a	d20 05c 07c	1/2 3/4 5/6 7/8		K39	91703-0006/9	93003-5992	A				
93003-5009	91703-0005/8	93002-7006	NONE	5b	d30 d70	1/2 6/7		K04	91703-0006/9	93003-5998	A				
93003-5008	91703-0005/8	93002-7007	NONE	2b 3b 4a 5a 6b	d10 02c 04c 08c d90	2/3 4/5 6/7 8/9		K40	91703-0006/9	93003-5991	A				
93003-5010	91703-0005/8	93002-7008	NONE	2b 5a	d80	2/3 7/8		K03	91703-0006/9	93003-5990	A				

10 CIRCUIT											SEE CODE DESIGNATION TABLE FOR NUMBERING FORMAT WHEN ADDING NEW PART NUMBERS				P.C.B. POLARISATION OPTION
PART NO. (TNI)	TERM NO. (TNI)	MOLEX HOUSING NO.	TERMINAL VOID POSITION	UNBLOCKED POSITION KEYS	UNBLOCKED CODING KEYS	LATCH POSITION	CONFIGURATION (SEE NOTES)	LUMBERG K REF.	TERM NO. (SILVER)	PART NO. (SILVER)					
93003-6002	91703-0005/8	93002-8000	NONE	2a 3b 6a 9a	03c d80	1/2 4/5 6/7 9/10		K30	91703-0006/9	93003-6997	A				
93003-6003	91703-0005/8	93002-8001	NONE	1a 3b 7b 9b	01c d20 d40 05c 07c	1/2 3/4 5/6 7/8 9/10		K35	91703-0006/9	93003-6996	A				
93003-6005	91703-0005/8	93002-8002	NONE	1b 2a 2b 4a 5b 6a 8a 9a 10a	d30 04c 06c 09c	1/2 4/5 6/7 9/10		K41	91703-0006/9	93003-6993	A				
93003-6006	91703-0005/8	93002-8003	NONE	1a 3b 4b 8a 10a 10b	01c d50 06c 07c d80 09c	1/2 4/5 7/8 9/10		K42	91703-0006/9	93003-6992	A				
93003-6007	91703-0005/8	93002-8004	NONE	2a 4b 8a 10a	d20 05c d70 08c	1/2 3/4 5/6 8/9		K44	91703-0006/9	93003-6991	A				
93003-6008	91703-0005/8	93002-8005	NONE	1b 2a 3a 4b 5b 9a	01c d40 d60 07c 09c d100	1/2 3/4 5/6 7/8 9/10		K48	91703-0006/9	93003-6990	A				
93003-6009	91703-0005/8	93002-8006	NONE	1a 4b 6b 9a	03c 04c d50 06c d70 08c d90	1/2 4/5 6/7 8/9		K38	91703-0006/9	93003-6989	A				
93003-6010	91703-0005/8	93002-8007	NONE	1a 3b 7b 8a	01c d20 d40 05c d100	1/2 3/4 5/6 7/8 9/10		K33	91703-0006/9	93003-6988	A				
93003-6012	91703-0005/8	93002-8008	NONE	10a	d20 08c	1/2 9/10		K56	91703-0006/9	93003-6987	A				
93003-6004	91703-0005/8	93002-8009	NONE	1b 3b 5b 9a	01c d60 07c 09c d100	1/2 3/4 5/6 7/8 9/10		K36	91703-0006/9	93003-6995	A				
93003-6011	91703-0005/8	93002-8010	NONE	1b 2b 4a 7a 9a	d20 d30 d50 06c d70 d80	1/2 4/5 6/7 9/10		K43	91703-0006/9	93003-6999	A				
93003-6013	91703-0005/8	93002-8011	NONE	1a 2a 2b 3a 4a 4b 5a 6a 6b 7a 8a 8b 9a 10a 10b	NONE	1/2 3/4 5/6 7/8 9/10		K45	91703-0006/9	93003-6985	A				
93003-6014	91703-0005/8	93002-8012	NONE	2a 2b 3a 4a 5a 9a 10a	d20 d40 07c d70 08c d100	1/2 3/4 5/6 8/9		K46	91703-0006/9	93003-6984	A				
93003-6017	91703-0005/8	93002-8013	NONE	1b 2a 3a 4b 6a 7a 8a 8b	01c d40 d60 d80	1/2 3/4 5/6 9/10		K49	91703-0006/9	93003-6981	A				
93003-6018	91703-0005/8	93002-8014	NONE	1b 5a 8b 9a 10b	03c d40 d80 09c	1/2 3/4 5/6 7/8 9/10		K50	91703-0006/9	93003-6980	A				
93003-6019	91703-0005/8	93002-8015	NONE	1b 3a 4a 4b 6b 9a 9b	01c d50 06c d70 09c	1/2 4/5 6/7 9/10		K51	91703-0006/9	93003-6979	A				
93003-6020	91703-0005/8	93002-8016	NONE	1b 4a 7a 9a	01c d20 06c d80 09c	1/2 4/5 7/8 9/10		K52	91703-0006/9	93003-6978	A				

SEE SHEET 1 SEC NO: IPG2017-0750 DRWNGZ: GRAMER CHKD: APPR: BRUTTE 2017/02/24	QUALITY SYMBOLS ▽=0 ▽=0	GENERAL TOLERANCES (UNLESS SPECIFIED) mm INCH 4 PLACES ± --- ± --- 3 PLACES ± --- ± --- 2 PLACES ± 0.1 ± --- 1 PLACE ± 0.2 ± --- 0 PLACE ± ±	DIMENSION STYLE MM ONLY	SCALE 1:1	DESIGN UNITS METRIC	THIRD ANGLE PROJECTION	
	DRAWN BY B. RUTLE 2006/10/10	DATE 2006/10/10	CHECKED BY T. TOURISH 2006/10/10	DATE 2006/10/10	APPROVED BY BMAGUIRE 2010/11/01	MATERIAL NO. SEE CHARTS	DOCUMENT NO. SD-93003-001
	DRAFT WHERE APPLICABLE MUST REMAIN WITHIN DIMENSIONS	SIZE 1	THIS DRAWING CONTAINS INFORMATION THAT IS PROPRIETARY TO MOLEX INCORPORATED AND SHOULD NOT BE USED WITHOUT WRITTEN PERMISSION	SHEET NO. 7 OF 8			

11 CIRCUIT											SEE CODE DESIGNATION TABLE FOR NUMBERING FORMAT WHEN ADDING NEW PART NUMBERS			P.C.B. POLARISATION OPTION
PART NO. (TIN)	TERM NO. (TIN)	MOLEX HOUSING NO.	TERMINAL VOID POSITION	UNBLOCKED POSITION KEYS	UNBLOCKED CODING KEYS	LATCH POSITION	CONFIGURATION (SEE NOTES)	LUMBERG K REF	TERM NO. (SILVER)	PART NO. (SILVER)				
93003-7001	91703-0005/8	93002-9000	NONE	1a 2b 3c 4a 4b 5a 7a 8a 9a 10a 11a	01c d40 05c 08c 010c	3/4 8/9		K33	91703-0006/9	93003-7999	A			
93003-7002	91703-0005/8	93002-9001	NONE	1a 1b 6b 7a 10a 11b	03c d40 d90	1/2 3/4 5/6 7/8 8/9 10/11		K30	91703-0006/9	93003-7997	A			
93003-7003	91703-0005/8	93002-9002	NONE	1a 2b 3c 4a 4b 5a 7a 8a 9a 10a 11a	01c d40 05c 08c 010c	1/2 3/4 5/6 8/9 10/11		K31	91703-0006/9	93003-7998	A			
93003-7004	91703-0005/8	93002-9003	NONE	2a 3b 4a 4b 5a 6b 7a 7b 10a 11b	01c d20 d40 d60 07c d90 010c	1/2 3/4 5/6 7/8 10/11		K32	91703-0006/9	93003-7996	A			
93003-7005	91703-0005/8	93002-9004	NONE	2a 3b 4a 4b 6a 6b 8b 10a 11a	01c d20 d40 06c 08c d90 010c	1/2 3/4 6/7 8/9 10/11		K34	91703-0006/9	93003-7995	A			
93003-7007	91703-0005/8	93002-9005	NONE	2a 4b 5b 7b 8a 11b	d10 d30 d50 d80 010c d110	2/3 4/5 7/8 10/11		K36	91703-0006/9	93003-7994	A			
93003-7008	91703-0005/8	93002-9006	NONE	1b 3a 4a 6a 7b 9b	01c d20 d40 05c d60 07c d80 09c d100	1/2 3/4 5/6 7/8 9/10		K37	91703-0006/9	93003-7992	A			
93003-7009	91703-0005/8	93002-9007	NONE	2a 6a 8a 11b	01c d50 d90 d110	2/3 4/5 6/7 8/9 10/11		K38	91703-0006/9	93003-7991	A			
93003-7010	91703-0005/8	93002-9008	NONE	1a 4a 6a 8a 11b	d30 d90 d110	1/2 4/5 6/7 8/9 10/11		K39	91703-0006/9	93003-7990	A			
93003-7013	91703-0005/8	93002-9009	NONE	1a 1b 2b 4a 5a 8b 9b	02c d80 09c d100	2/3 5/6 7/8 9/10		K46	91703-0006/9	93003-7989	A			
93003-7014	91703-0005/8	93002-9010	NONE	1b 5b 6b 8b 9b 10a 10b	01c d20 d40 05c d70 08c 010c	1/2 5/6 8/9 10/11		K47	91703-0006/9	93003-7986	A			
93003-7015	91703-0005/8	93002-9011	NONE	1a 2b 3b 5a 6a 8a 9b	d20 03c 06c 09c d100	1/2 3/4 6/7 9/10		K44	91703-0006/9	93003-7985	A			
93003-7016	91703-0005/8	93002-9012	NONE	1b 4a 7b 9b 10b	01c d20 04c d80 011c d110	1/2 4/5 6/7 9/10		K45	91703-0006/9	93003-7984	A			
93003-7017	91703-0005/8	93002-9013	NONE	1b 11b	03c d90	3/4 8/9		K43	91703-0006/9	93003-7983	A			
93003-7006	91703-0005/8	93002-9014	NONE	1b 2a 3a 4b 6b	01c d40 d60 011c	1/2 3/4 5/6 7/8 9/10		K35	91703-0006/9	93003-7993	A			
93003-7011	91703-0005/8	93002-9015	NONE	1b 3a 4b 7a 10b	01c 04c d50 07c	1/2 4/5 7/8 9/10		K40	91703-0006/9	93003-7988	A			
93003-7012	91703-0005/8	93002-9016	NONE	1b 2a 3a 4b 6b 7a 8a 8b	01c d40 d60 d80 011c	1/2 3/4 5/6 9/10		K42	91703-0006/9	93003-7987	A			

12 CIRCUIT											SEE CODE DESIGNATION TABLE FOR NUMBERING FORMAT WHEN ADDING NEW PART NUMBERS			P.C.B. POLARISATION OPTION
PART NO. (TIN)	TERM NO. (TIN)	MOLEX HOUSING NO.	TERMINAL VOID POSITION	UNBLOCKED POSITION KEYS	UNBLOCKED CODING KEYS	LATCH POSITION	CONFIGURATION (SEE NOTES)	LUMBERG K REF	TERM NO. (SILVER)	PART NO. (SILVER)				
93003-8002	91703-0005/8	93002-9500	NONE	1b 7a 8b 12b	d10 06c 09c d100 d120	2/3 4/5 7/8 11/12		K30	91703-0006/9	93003-8997	A			
93003-8001	91703-0005/8	93002-9501	NONE	2a 4b 5b 6b 7a 10b 12a 12b	d10 d30 d50 d70 09c d100 d120	2/3 4/5 6/7 9/10 11/12		K34	91703-0006/9	93003-8996	A			
93003-8003	91703-0005/8	93002-9502	NONE	1a 3b 7b 9b 11b 12a	01c d20 d40 05c 07c 011c	1/2 3/4 5/6 7/8 9/10 11/12		K44	91703-0006/9	93003-8995	A			
93003-8004	91703-0005/8	93002-9503	NONE	1b 2a 2b 4a 5b 6a 8a 9a 10a 11a 12b	d30 04c 06c 09c 011c	1/2 4/5 6/7 9/10 11/12		K46	91703-0006/9	93003-8994	A			
93003-8005	91703-0005/8	93002-9504	NONE	2b 3b 4a 8b 9b 11a	01c d20 d40 d90 d100 d120	1/2 3/4 8/9 11/12		K49	91703-0006/9	93003-8992	A			
93003-8006	91703-0005/8	93002-9505	NONE	1a 2b 3a 5b 11b 12a	01c 03c d40 d60 07c 09c	1/2 3/4 5/6 7/8 9/10 11/12		K47	91703-0006/9	93003-8993	A			
93003-8008	91703-0005/8	93002-9506	NONE	1a 5b 7b	01c d30 04c d70 012c	2/3 4/5 6/7 8/9 10/11		K50	91703-0006/9	93003-8991	A			

SEE SHEET 1 SEC NO: IPG2017-0750 DRAWING: CRAMER CHKD: AR APPR: BRUTTLE 2017/02/24	QUALITY SYMBOLS	GENERAL TOLERANCES (UNLESS SPECIFIED)	DIMENSION STYLE	SCALE	DESIGN UNITS	THIRD ANGLE PROJECTION	
	$\nabla=0$ $\nabla=0$	mm INCH 4 PLACES ± --- ± --- 3 PLACES ± --- ± --- 2 PLACES ± 0.1 ± --- 1 PLACE ± 0.2 ± --- 0 PLACE ± ±	M M ONLY	DRAWN BY DATE B. RUTTLE 2006/10/10 CHECKED BY DATE T. TOURISH 2006/10/10 APPROVED BY DATE BMAGUIRE 2010/11/01	1:1	METRIC	RAST 5 R.A. HDR PA 66 HOUSING
	ANGULAR ± 2 ° DRAFT WHERE APPLICABLE MUST REMAIN WITHIN DIMENSIONS	SEE CHARTS	MATERIAL NO. SD-93003-001	DOCUMENT NO. SD-93003-001	SHEET NO. 8 OF 8		
	THIS DRAWING CONTAINS INFORMATION THAT IS PROPRIETARY TO MOLEX INCORPORATED AND SHOULD NOT BE USED WITHOUT WRITTEN PERMISSION						

X-ON Electronics

Largest Supplier of Electrical and Electronic Components

Click to view similar products for [Power to the Board](#) category:

Click to view products by [Molex](#) manufacturer:

Other Similar products are found below :

[6450171-4](#) [6450552-7](#) [6600323-8](#) [6643429-1](#) [6646040-2](#) [6651939-1](#) [6766604-1](#) [120959-1](#) [1393557-2](#) [1393532-2](#) [1393532-3](#) [1393532-4](#)
[1393557-1](#) [1600812-5](#) [1-6450861-2](#) [1744132-7](#) [1761122-1](#) [1766250-1](#) [1892109-1](#) [2-6450860-5](#) [2-6450870-0](#) [1-6450161-4](#) [1-6450850-6](#) [1-6450869-6](#) [1645526-2](#) [1-6600130-0](#) [2005243-2](#) [377-0020-11130](#) [TE34-12-16P-F0](#) [5-6450830-6](#) [5646956-4](#) [377-0080-11131A](#) [4-6450830-9](#)
[4-6600333-3](#) [10125416-4050LF](#) [6600320-3](#) [3-6450860-5](#) [1888123-2](#) [6450166-1](#) [6643978-1](#) [6766605-1](#) [701-15-02109](#) [N11444](#) [6651938-1](#)
[6450810-7](#) [46437-1112](#) [1-1589677-8](#) [5646956-5](#) [6450813-2](#) [6450129-4](#)