

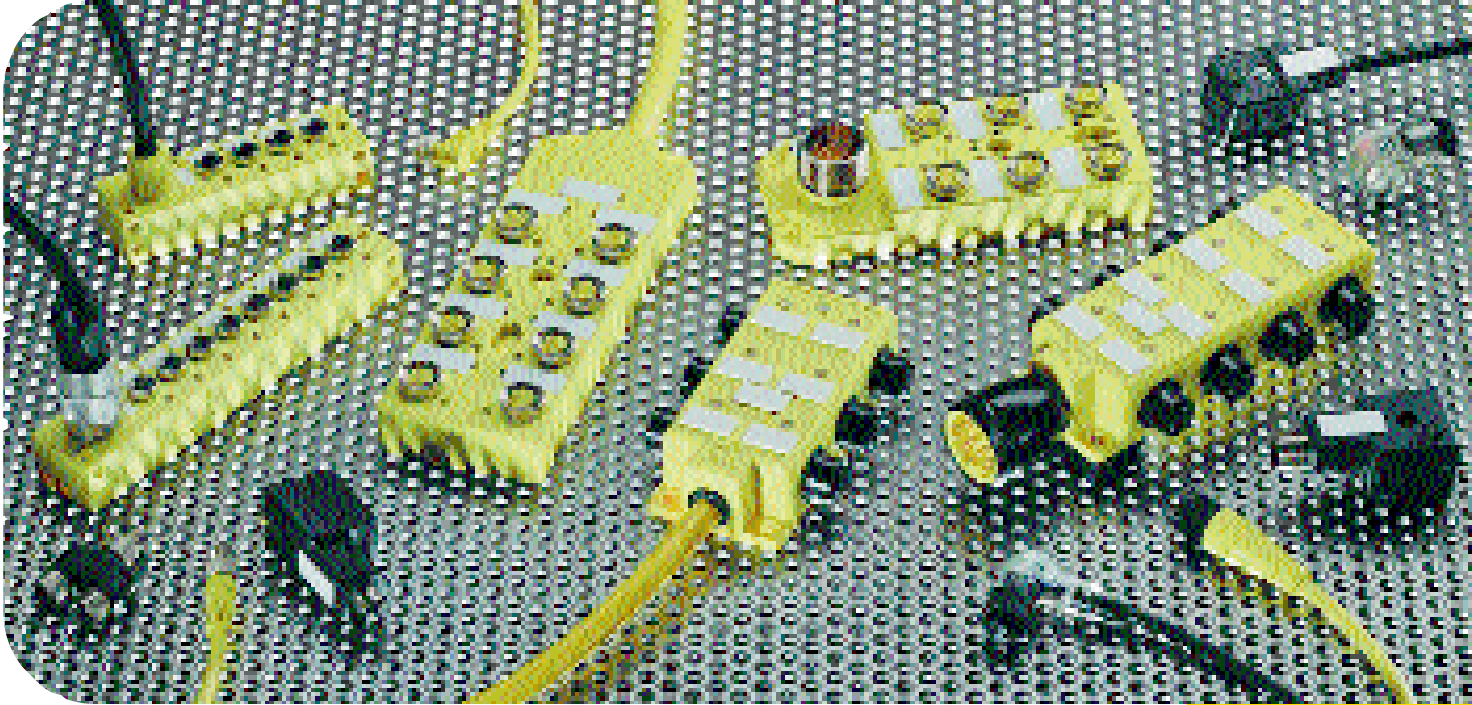

INDUSTRIAL AUTOMATION CONNECTOR SYSTEMS



**CONNECTING TOMORROW'S
TECHNOLOGY, TODAY.**



W Woodhead Connectivity

SST™ • Brad Harrison® • mPm™ • RJ·Lnxx™ • Applicom™

BRAD HARRISON® AND MPM® CONNECTOR SYSTEMS

Brad Harrison® originally started manufacturing moulded connectors in 1946 for the steel, automotive and mining industries. It was acquired by Woodhead Industries Inc. in 1969 after which the Mini-Change® connector was introduced. It's development was as a direct

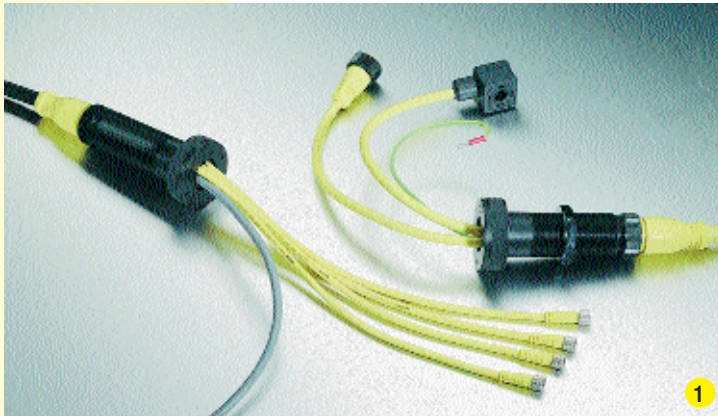

1

result of working with the automotive industry to produce a quick disconnect solution to hard wired control devices such as proximity and limit switches, valves and other devices.

Similarly, mPm® a family owned company was founded in 1973, evolved to service the expanding solenoid valve market. They rapidly developed into the market leader for DIN 43650 style connectors, and joined the group in 1998.

The two market leading brands provide a solid foundation of robust and reliable products from a flexible and supportive manufacturer for both end users and OEMs in industrial segments. Our range has been developed to provide the same high quality product and design for other market sectors such as instrumentation, transportation and materials handling to name just a few.

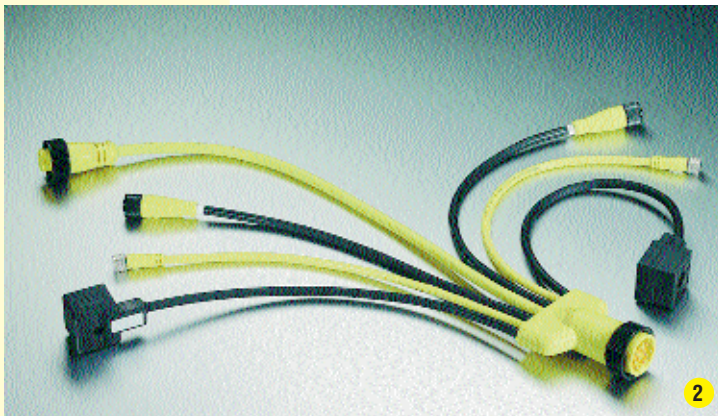

2

This catalogue has been specifically designed to cover the connector requirements of customers using industrial automation products – solenoid valves, proximity, photoelectric, capacitive, reed, hall effect and limit switches together with our latest offering in Multi-Port Splitter Boxes – but is not the limit of our capability or product range. Shown are some examples of customised solutions designed for specific applications.



3

1 Mini-Change® receptacles with integral wiring of Nano-Change® Mini-Change® and mPm® connectors for control functions. This provided a through panel connection system, which provides a water proof (IP67) solution for control systems in harsh operating conditions.

2 The Multi-In-Line Splitter is a complete wiring system built into one connector. In this case it has been used to provide a solution for wiring proximity switches and solenoid valves with the choice of either a home run connector or panel mounted receptacle for the control installation.

3 The ultimate wiring systems, this is a model of a complete plug and play solution for wiring a complex mixing machine. This comprises a variety of connector types together with a shielded circuit for drive motors.

4 Finally, a range of PCB and panel mount multi-pole Mini-Change® receptacles for integration into a control system, where environmental protection is required and a robust design.



4

In order to choose the correct connectors for your system, it is important to note the various type of connectors available. Below is a short introduction to guide you to the correct part of the catalogue.

Nano-Change® (M8) Multi-Port Systems

The Nano-Change® 3 and 4 pole connectors are not interchangeable, so care has to be taken in selecting the correct product.

Typically, inductive, reed and Hall effect switches and a limited range of photoelectric sensors use 3 pole connectors. Where as many photoelectric switches use the 4 pole connector, in this case pin 2 is typically used for programming the device or as an alarm output.

Using the In-line Splitter, a 4 pole twin I/O unit can be used to connect two devices per port, so doubling the capacity of the system.

- 3 Pole – Single I/O units 5
- 4 Pole – Twin I/O units 6
- M16 Home Run Connectors 7
- M8 to M8 Sensor/Input Jumpers 8
- M12 to M8 Sensor/Input Jumpers 9
- Solenoid Valve to M8 Output Jumpers 10
- M12 to M8 Adapters and Splitters 13
- Solenoid Valve to M8 Adapters 14

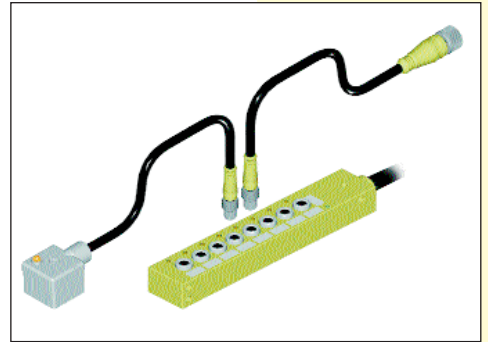

Micro-Change® (M12) Multi-Port Systems

The single I/O or 4 wire units, have common power and earth circuits, plus I/O from each port. These are fully compatible with all sensors and solenoids with the additional choice of either PNP or NPN LED indication of power and status.

The twin I/O or 5 wire units allow for two devices (input or output) to be connected per port doubling the capacity of the unit. Using a 4 pole, 4 wire jumper cable with these units completes the connection for switches with programming functions or complementary outputs.

- 4 Wire – Top-Mount – Single I/O Units 16
- 5 Wire – Top-Mount – Twin I/O Units 17
- 4 Wire – Side-Mount – Single I/O Units 18
- M23 Home Run Connectors 19
- Mini-Change® Home Run Connectors 20
- M8 to M12 Sensor Jumpers 21
- M12 to M12 Sensor Jumpers 22
- Solenoid Valve to M12 Output Jumpers 23
- M8 to M12 Adapters and Splitters 26
- Solenoid Valve to M12 Adapters 27

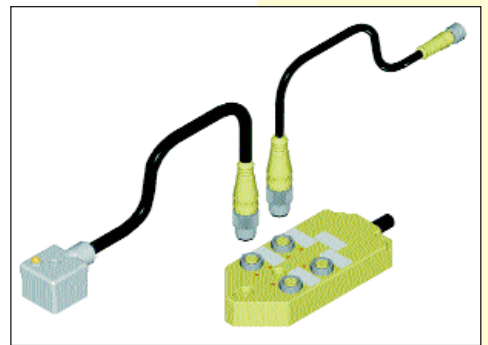

Nano-Change® (M8) 3, 4 and 5 pole connectors

Nano-Change® is available in 3, 4 and 5 pole designs with either a snap fit or M8 threaded coupling nut. Versions with LED indication show power to the device while a separate LED reports the signal status (on or off).

The range is complemented by panel mount receptacles either with PCB or wire tails.

- Moulded Snap Connectors 29
- Moulded Coupler Connectors 30
- Attachable Connectors 31
- Female and Male Receptacles 31

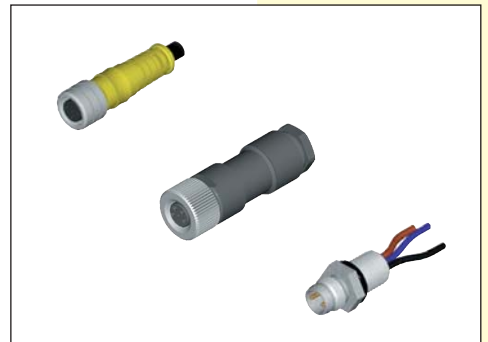

Micro-Change® (M12) 3, 4, 5 and 8 pole connectors

Micro-Change® single key way connectors are available as 3, 4, 5 or 8 pole. The 3, 4 and 5 poles devices are fully interchangeable for maximum flexibility.

Female and male attachable connectors with screw terminals and choice of gland size on the straight versions, plus a range of panel and PCB mount receptacles, complete the range.

- Moulded Connectors 33
- Attachable Connectors 34
- Female and Male Receptacles 35



mPm® DIN 43650 Form A, B and C connectors

The mPm® Din 43650 Form A, B and C connectors provide the option of fully moulded or field attachable versions.

In each case, choice of either connectors with or without indication and suppression circuits are available.

- Moulded Connectors 37
- Attachable Connectors 39
- Part Number Matrixes and Connector Specification 40
- Multi-Port and Cable Specification 41
- Dimensional Information 42

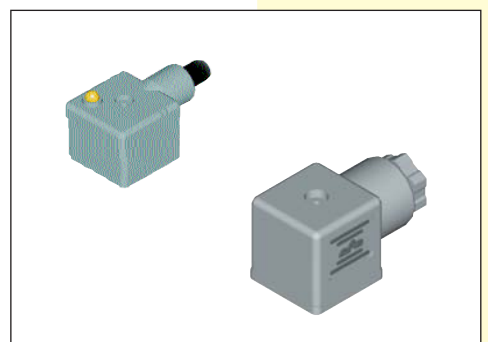

NANO-CHANGE® MULTI-PORT SPLITTER BOX SYSTEMS

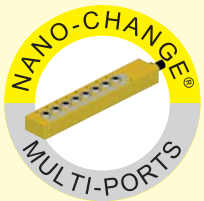
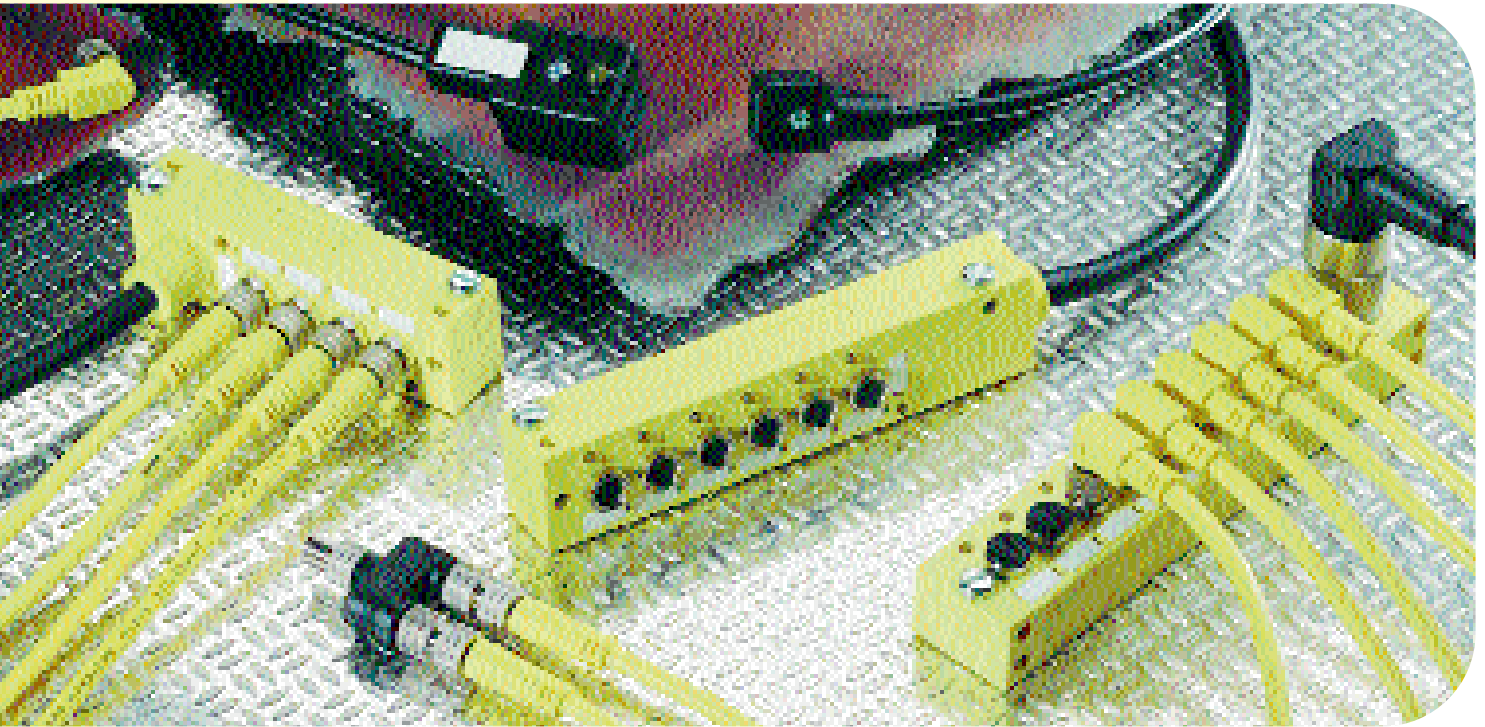

- **Compact design fits into small and previously inaccessible spaces helping to minimise overall machine size**
- **Factory built and tested units, cuts the demand on highly skilled workforce and decreases machine built time, whilst eliminating wiring errors**
- **Simplifies control systems, reducing the size of cable trays, trunking and control cabinets by cutting the number of cables and terminals required**
- **Three case styles each providing choice of three mounting positions with twin I/O units providing connections for 100 devices in just over the space of a CD case**



3 pole – Single I/O Multi-Ports

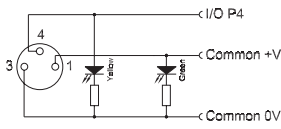

Function	Cable Colour	M16 Connector Pin No	M12 Connector Pin No	Function	Cable Colour	M16 Connector Pin No	M12 Connector Pin No	Function	Cable Colour	M16 Connector Pin No
+V	Brown	A&M	5	Port 5 P4	Pink	G	6	Port 9 P4	White/Blue	C
0V	Blue	L&U	7	Port 6 P4	Red	R	8	Port 10 P4	Brown/Blue	N
Port 1 P4	White	P	1	Port 7 P4	Black	E				
Port 2 P4	Green	J	2	Port 8 P4	Violet	0				
Port 3 P4	Yellow	T	3							
Port 4 P4	Grey	S	4							

Cable

Length (m)

Integral End Cable Entry

4 Port

6 Port

8 Port

10 Port

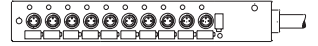
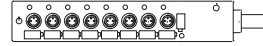
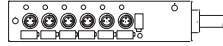
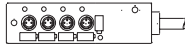
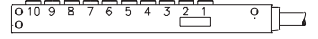
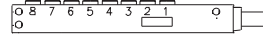
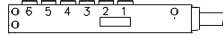
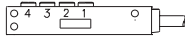

PUR		4 Port	6 Port	8 Port	10 Port
5.0		BEY401P-FBP-05	BEY601P-FBP-05	BEY801P-FBP-05	BEYA01P-FBP-05
10.0		BEY401P-FBP-10	BEY601P-FBP-10	BEY801P-FBP-10	BEYA01P-FBP-10
20.0		BEY401P-FBP-20	BEY601P-FBP-20	BEY801P-FBP-20	BEYA01P-FBP-20

Integral Top Cable Entry

4 Port

6 Port

8 Port

10 Port

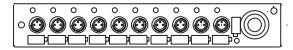
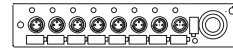
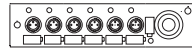
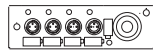
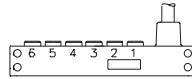
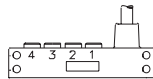

PUR		4 Port	6 Port	8 Port	10 Port
5.0		BNY401P-FBP-05	BNY601P-FBP-05	BNY801P-FBP-05	BNYA01P-FBP-05
10.0		BNY401P-FBP-10	BNY601P-FBP-10	BNY801P-FBP-10	BNYA01P-FBP-10
20.0		BNY401P-FBP-20	BNY601P-FBP-20	BNY801P-FBP-20	BNYA01P-FBP-20

Integral M16 14 Pole Home Run Connector

4 Port

6 Port

8 Port

10 Port



See top of page 7 for connectors

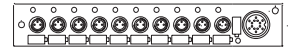
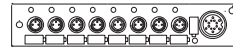
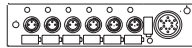
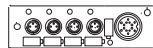
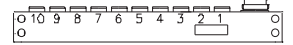
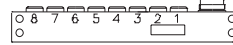
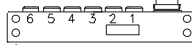
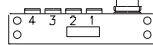

4 Port	6 Port	8 Port	10 Port
BNY401P-FBC	BNY601P-FBC	BNY801P-FBC	BNYA01P-FBC

Integral M12 8 Pole Home Run Connector

4 Port

6 Port

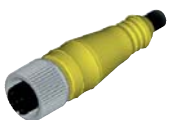

See page 33 for connectors

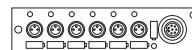
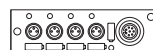
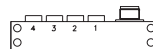

4 Port	6 Port
BNY401P-FBF	BNY601P-FBF

Nano-Change® (M8) Multi-Port Splitter Boxes

4 pole – Twin I/O Multi-Ports

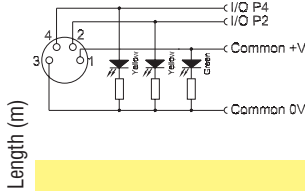
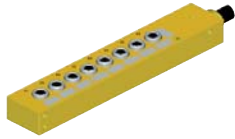

Function	Cable Colour	M16 Connector Pin No	Function	Cable Colour	M16 Connector Pin No	Function	Cable Colour	M16 Connector Pin No	Function	Cable Colour	M16 Connector Pin No
+V	Brown	A									
0V	Blue	L									
Port 1 P4	White	U	Port 6 P4	Red	N	Port 1 P2	Grey/Pink	P	Port 6 P2	Yellow/Brown	C
Port 2 P4	Green	J	Port 7 P4	Black		Port 2 P2	Red/Blue	S	Port 7 P2	White/Grey	
Port 3 P4	Yellow	M	Port 8 P4	Violet		Port 3 P2	White/Green	T	Port 8 P2	Grey/Brown	
Port 4 P4	Grey	R	Port 9 P4	White/Blue		Port 4 P2	Brown/Green	G	Port 9 P2	White/Pink	
Port 5 P4	Pink	O	Port 10 P4	Brown/Blue		Port 5 P2	White/Yellow	E	Port 10 P2	Pink/Brown	

Integral End Cable Entry

4 Port

6 Port

8 Port

10 Port

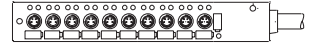
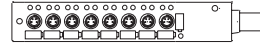
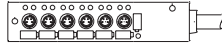
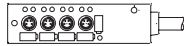
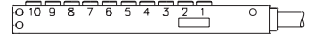
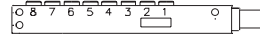
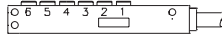
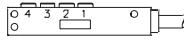

PUR	Length (m)	4 Port	6 Port	8 Port	10 Port
	5.0	BEY403P-FBP-05	BEY603P-FBP-05	BEY803P-FBP-05	BEYA03P-FBP-05
	10.0	BEY403P-FBP-10	BEY603P-FBP-10	BEY803P-FBP-10	BEYA03P-FBP-10
	20.0	BEY403P-FBP-20	BEY603P-FBP-20	BEY803P-FBP-20	BEYA03P-FBP-20

Integral Top Cable Entry

4 Port

6 Port

8 Port

10 Port

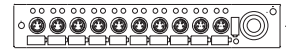
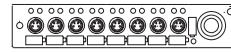
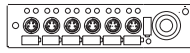
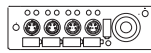
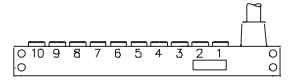
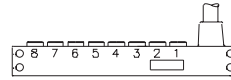
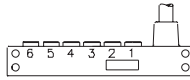
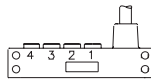

PUR	Length (m)	4 Port	6 Port	8 Port	10 Port
	5.0	BNY403P-FBP-05	BNY603P-FBP-05	BNY803P-FBP-05	BNYA03P-FBP-05
	10.0	BNY403P-FBP-10	BNY603P-FBP-10	BNY803P-FBP-10	BNYA03P-FBP-10
	20.0	BNY403P-FBP-20	BNY603P-FBP-20	BNY803P-FBP-20	BNYA03P-FBP-20

Integral M16 Home Run Connector

4 Port

6 Port

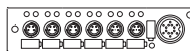
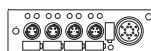
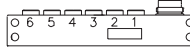
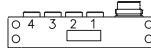

See bottom of page 7 for connectors

BNY403P-FBC

BNY603P-FBC

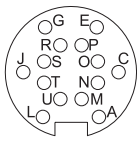

Female Connector Face View

Function	M16 Connector Pin No	Cable Colour	Function	M16 Connector Pin No	Cable Colour	Function	M16 Connector Pin No	Cable Colour
+V	A&M	Brown						
0V	L&U	Blue						
Port 1 P4	P	White	Port 5 P4	G	Pink	Port 9 P4	C	White/Blue
Port 2 P4	J	Green	Port 6 P4	R	Red	Port 10 P4	N	Brown/Blue
Port 3 P4	T	Yellow	Port 7 P4	E	Black			
Port 4 P4	S	Grey	Port 8 P4	O	Violet			

Female Connector

Cable Length (m)

Female Straight

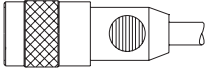

	BNY401P-FBC 3 Pole/4 Port	BNY601P-FBC 3 Pole/6 Port	BNY801P-FBC 3 Pole/8 Port	BNYA01P-FBC 3 Pole/10 Port
PUR 5.0	L04300M78M050	L04200M78M050	L04100M78M050	L04A00M78M050
10.0	L04300M78M100	L04200M78M100	L04100M78M100	L04A00M78M100
20.0	L04300M78M200	L04200M78M200	L04100M78M200	L04A00M78M200

Female 90°

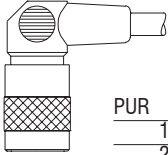

PUR 5.0	L04301M78M050	L04201M78M050	L04101M78M050	L04A01M78M050
10.0	L04301M78M100	L04201M78M100	L04101M78M100	L04A01M78M100
20.0	L04301M78M200	L04201M78M200	L04101M78M200	L04A01P78M200

Home Run Connectors for Nano-Change® Single I/O Multi-Ports

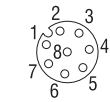
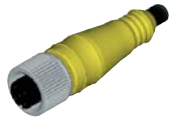

Female Connector Face View

Function	M12 Connector Pin No	Cable Colour
+V	5	Brown
0V	7	Blue
Port 1 P4	1	White
Port 2 P4	2	Green
Port 3 P4	3	Yellow
Port 4 P4	4	Grey
Port 5 P4	6	Pink
Port 6 P4	8	Red

Female Straight

Micro-Change (M12) 8 Pole Home Run Connectors for Nano-Change Single I/O Multi-Ports

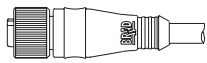

	BNY401P-FBF 3 Pole/4 Port	BNY601P-FBF 3 Pole/6 Port
PUR 5.0	808300P78M050	808200P78M050
10.0	808300P78M100	808200P78M100
20.0	808300P78M200	808200P78M200

Female 90°

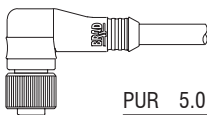

PUR 5.0	808301P78M050	808201P78M050
10.0	808301P78M100	808201P78M100
20.0	808301P78M200	808201P78M200

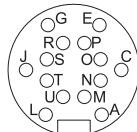

Female Connector Face View

Function	M16 Connector Pin No	Cable Colour	Function	M16 Connector Pin No	Cable Colour	Function	M16 Connector Pin No	Cable Colour	Function	M16 Connector Pin No	Cable Colour
+V	A	Brown									
0V	L	Blue									
Port 1 P4	U	White	Port 4 P4	R	Grey	Port 1 P2	P	Grey/Pink	Port 4 P2	G	Brown/Green
Port 2 P4	J	Green	Port 5 P4	O	Pink	Port 2 P2	S	Red/Blue	Port 5 P2	E	White/Yellow
Port 3 P4	M	Yellow	Port 6 P4	N	Red	Port 3 P2	T	White/Green	Port 6 P2	C	Yellow/Brown

Home Run Connector for Nano-Change® Twin I/O Multi-Ports

Female Straight

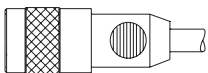

	BNY403P-FBC 4 Pole/4 Port	BNY603P-FBC 4 Pole/6 Port
PUR 5.0	L044000P78M050	L04000P78M050
10.0	L044000P78M100	L04000P78M100
20.0	L044000P78M200	L04000P78M200

Female 90°

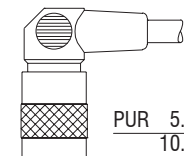

PUR 5.0	L04401P78M050	L04001P78M050
10.0	L04401P78M100	L04001P78M100
20.0	L04401P78M200	L04001P78M200

Nano-Change® (M8) Jumper Cables



M8 3 Pole – Single I/O Multi-Port

M8 4 Pole – Twin I/O Multi-Port

Female Connector

Cable

Length (m)



- 1 Brown
- 3 Blue
- 4 Black

WIRING CONFIGURATION



- 1 Brown
- 2 White
- 3 Blue
- 4 Black

WIRING CONFIGURATION

Nano-Change® (M8) Straight



- 1 Brown
- 3 Blue
- 4 Black

Material	Length (m)	Part No. 1	Part No. 2	Part No. 3	Part No. 4
PVC	0.6	443030E03M006	443032E03M006	443430E03M006	443432E03M006
	1.0	443030E03M010	443032E03M010	443430E03M010	443432E03M010
	2.0	443030E03M020	443032E03M020	443430E03M020	443432E03M020
	3.0	443030E03M030	443032E03M030	443430E03M030	443432E03M030
PUR	0.6	443030P03M006	443032P03M006	443430P03M006	443432P03M006
	1.0	443030P03M010	443032P03M010	443430P03M010	443432P03M010
	2.0	443030P03M020	443032P03M020	443430P03M020	443432P03M020
	3.0	443030P03M030	443032P03M030	443430P03M030	443432P03M030

Nano-Change® (M8) 90°

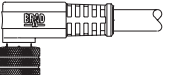

- 1 Brown
- 3 Blue
- 4 Black

Material	Length (m)	Part No. 1	Part No. 2	Part No. 3	Part No. 4
PVC	0.6	443031E03M006	443033E03M006	443431E03M006	443433E03M006
	1.0	443031E03M010	443033E03M010	443431E03M010	443433E03M010
	2.0	443031E03M020	443033E03M020	443431E03M020	443433E03M020
	3.0	443031E03M030	443033E03M030	443431E03M030	443433E03M030
PUR	0.6	443031P03M006	443033P03M006	443431P03M006	443433P03M006
	1.0	443031P03M010	443033P03M010	443431P03M010	443433P03M010
	2.0	443031P03M020	443033P03M020	443431P03M020	443433P03M020
	3.0	443031P03M030	443033P03M030	443431P03M030	443433P03M030

Nano-Change® (M8) 90° PNP LED

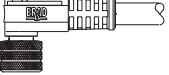

- 1 Brown
- 3 Blue
- 4 Black

Material	Length (m)	Part No. 1	Part No. 2	Part No. 3	Part No. 4
PVC	0.6	4430P7E03M006	4430P9E03M006	4434P7E03M006	4434P9E03M006
	1.0	4430P7E03M010	4430P9E03M010	4434P7E03M010	4434P9E03M010
	2.0	4430P7E03M020	4430P9E03M020	4434P7E03M020	4434P9E03M020
	3.0	4430P7E03M030	4430P9E03M030	4434P7E03M030	4434P9E03M030
PUR	0.6	4430P7P03M006	4430P9P03M006	4434P7P03M006	4434P9P03M006
	1.0	4430P7P03M010	4430P9P03M010	4434P7P03M010	4434P9P03M010
	2.0	4430P7P03M020	4430P9P03M020	4434P7P03M020	4434P9P03M020
	3.0	4430P7P03M030	4430P9P03M030	4434P7P03M030	4434P9P03M030

Nano-Change® (M8) Straight

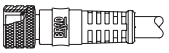

- 1 Brown
- 2 White
- 3 Blue
- 4 Black

Material	Length (m)	Part No. 1	Part No. 2	Part No. 3	Part No. 4
PVC	0.6	444330E03M006	444332E03M006	444030E03M006	444032E03M006
	1.0	444330E03M010	444332E03M010	444030E03M010	444032E03M010
	2.0	444330E03M020	444332E03M020	444030E03M020	444032E03M020
	3.0	444330E03M030	444332E03M030	444030E03M030	444032E03M030
PUR	0.6	444330P03M006	444332P03M006	444030P03M006	444032P03M006
	1.0	444330P03M010	444332P03M010	444030P03M010	444032P03M010
	2.0	444330P03M020	444332P03M020	444030P03M020	444032P03M020
	3.0	444330P03M030	444332P03M030	444030P03M030	444032P03M030

Nano-Change® (M8) 90°

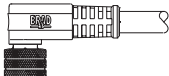

- 1 Brown
- 2 White
- 3 Blue
- 4 Black

Material	Length (m)	Part No. 1	Part No. 2	Part No. 3	Part No. 4
PVC	0.6	444331E03M006	444333E03M006	444031E03M006	444033E03M006
	1.0	444331E03M010	444333E03M010	444031E03M010	444033E03M010
	2.0	444331E03M020	444333E03M020	444031E03M020	444033E03M020
	3.0	444331E03M030	444333E03M030	444031E03M030	444033E03M030
PUR	0.6	444331P03M006	444333P03M006	444031P03M006	444033P03M006
	1.0	444331P03M010	444333P03M010	444031P03M010	444033P03M010
	2.0	444331P03M020	444333P03M020	444031P03M020	444033P03M020
	3.0	444331P03M030	444333P03M030	444031P03M030	444033P03M030

Options: NPN format LED indication, choice of cables, see page 40 for more information

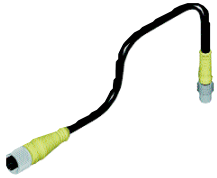

M8 3 Pole – Single I/O Multi-Port

M8 4 Pole – Twin I/O Multi-Port

Female Connector

Cable

Length (m)

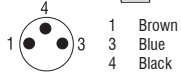

- 1 Brown
- 3 Blue
- 4 Black

WIRING CONFIGURATION



- 1 Brown
- 2 White
- 3 Blue
- 4 Black

WIRING CONFIGURATION

Micro-Change® (M12) Straight



- 1 Brown
- 2 White*
- 3 Blue
- 4 Black

		843030E03M006	843032E03M006	844030E03M006	844032E03M006
PVC	0.6	843030E03M006	843032E03M006	844030E03M006	844032E03M006
	1.0	843030E03M010	843032E03M010	844030E03M010	844032E03M010
	2.0	843030E03M020	843032E03M020	844030E03M020	844032E03M020
	3.0	843030E03M030	843032E03M030	844030E03M030	844032E03M030
PUR	0.6	843030P03M006	843032P03M006	844030P03M006	844032P03M006
	1.0	843030P03M010	843032P03M010	844030P03M010	844032P03M010
	2.0	843030P03M020	843032P03M020	844030P03M020	844032P03M020
	3.0	843030P03M030	843032P03M030	844030P03M030	844032P03M030

Micro-Change® (M12) 90°

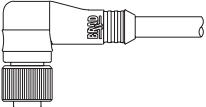

- 1 Brown
- 2 White*
- 3 Blue
- 4 Black

		843031E03M006	843033E03M006	844031E03M006	844033E03M006
PVC	0.6	843031E03M006	843033E03M006	844031E03M006	844033E03M006
	1.0	843031E03M010	843033E03M010	844031E03M010	844033E03M010
	2.0	843031E03M020	843033E03M020	844031E03M020	844033E03M020
	3.0	843031E03M030	843033E03M030	844031E03M030	844033E03M030
PUR	0.6	843031P03M006	843033P03M006	844031P03M006	844033P03M006
	1.0	843031P03M010	843033P03M010	844031P03M010	844033P03M010
	2.0	843031P03M020	843033P03M020	844031P03M020	844033P03M020
	3.0	843031P03M030	843033P03M030	844031P03M030	844033P03M030

Micro-Change® (M12) PNP LED

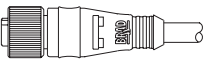

- 1 Brown
- 2 White*
- 3 Blue
- 4 Black

		8430P6E03M006	8430P8E03M006	8440P6E03M006	8440P8E03M006
PVC	0.6	8430P6E03M006	8430P8E03M006	8440P6E03M006	8440P8E03M006
	1.0	8430P6E03M010	8430P8E03M010	8440P6E03M010	8440P8E03M010
	2.0	8430P6E03M020	8430P8E03M020	8440P6E03M020	8440P8E03M020
	3.0	8430P6E03M030	8430P8E03M030	8440P6E03M030	8440P8E03M030
PUR	0.6	8430P6P03M006	8430P8P03M006	8440P6P03M006	8440P8P03M006
	1.0	8430P6P03M010	8430P8P03M010	8440P6P03M010	8440P8P03M010
	2.0	8430P6P03M020	8430P8P03M020	8440P6P03M020	8440P8P03M020
	3.0	8430P6P03M030	8430P8P03M030	8440P6P03M030	8440P8P03M030

Micro-Change® (M12) 90° PNP LED

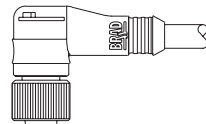

- 1 Brown
- 2 White*
- 3 Blue
- 4 Black

		8430P7E03M006	8430P9E03M006	8440P7E03M006	8440P9E03M006
PVC	0.6	8430P7E03M006	8430P9E03M006	8440P7E03M006	8440P9E03M006
	1.0	8430P7E03M010	8430P9E03M010	8440P7E03M010	8440P9E03M010
	2.0	8430P7E03M020	8430P9E03M020	8440P7E03M020	8440P9E03M020
	3.0	8430P7E03M030	8430P9E03M030	8440P7E03M030	8440P9E03M030
PUR	0.6	8430P7P03M006	8430P9P03M006	8440P7P03M006	8440P9P03M006
	1.0	8430P7P03M010	8430P9P03M010	8440P7P03M010	8440P9P03M010
	2.0	8430P7P03M020	8430P9P03M020	8440P7P03M020	8440P9P03M020
	3.0	8430P7P03M030	8430P9P03M030	8440P7P03M030	8440P9P03M030

* White not used on single I/O connectors

Nano-Change® (M8) Jumper Cables

M8 3 Pole – Single I/O Multi-Port

M8 4 Pole – Twin I/O Multi-Port

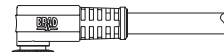
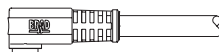

Female Connector

Cable

Length (m)

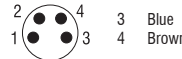
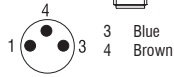

Form A (18mm) 2 pole + earth

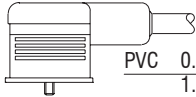
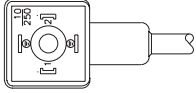

- 1 Brown
- 2 Blue
- 3 Yellow/Green*

Cable	Length (m)	Part No.	Part No.	Part No.	Part No.
PVC	0.6	E43000E12M006	E43002E12M006	E44000E12M006	E44002E12M006
	1.0	E43000E12M010	E43002E12M010	E44000E12M010	E44002E12M010
	2.0	E43000E12M020	E43002E12M020	E44000E12M020	E44002E12M020
	3.0	E43000E12M030	E43002E12M030	E44000E12M030	E44002E12M030
PUR	0.6	E43000P12M006	E43002P12M006	E44000P12M006	E44002P12M006
	1.0	E43000P12M010	E43002P12M010	E44000P12M010	E44002P12M010
	2.0	E43000P12M020	E43002P12M020	E44000P12M020	E44002P12M020
	3.0	E43000P12M030	E43002P12M030	E44000P12M030	E44002P12M030

Form A (18mm) 2 pole + earth – 24 V LED & VDR

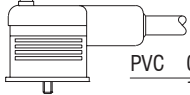
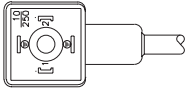

- 1 Brown
- 2 Blue
- 3 Yellow/Green*

Cable	Length (m)	Part No.	Part No.	Part No.	Part No.
PVC	0.6	E430B0E12M006	E430B2E12M006	E440B0E12M006	E440B2E12M006
	1.0	E430B0E12M010	E430B2E12M010	E440B0E12M010	E440B2E12M010
	2.0	E430B0E12M020	E430B2E12M020	E440B0E12M020	E440B2E12M020
	3.0	E430B0E12M030	E430B2E12M030	E440B0E12M030	E440B2E12M030
PUR	0.6	E430B0P12M006	E430B2P12M006	E440B0P12M006	E440B2P12M006
	1.0	E430B0P12M010	E430B2P12M010	E440B0P12M010	E440B2P12M010
	2.0	E430B0P12M020	E430B2P12M020	E440B0P12M020	E440B2P12M020
	3.0	E430B0P12M030	E430B2P12M030	E440B0P12M030	E440B2P12M030

Form B Ind (11mm) 2 pole + 12 o'clock earth

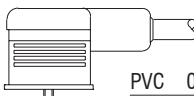
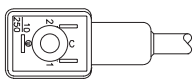

- 1 Brown
- 2 Blue
- 3 Yellow/Green*

Cable	Length (m)	Part No.	Part No.	Part No.	Part No.
PVC	0.6	F43001E12M006	F43003E12M006	F44001E12M006	F44003E12M006
	1.0	F43001E12M010	F43003E12M010	F44001E12M010	F44003E12M010
	2.0	F43001E12M020	F43003E12M020	F44001E12M020	F44003E12M020
	3.0	F43001E12M030	F43003E12M030	F44001E12M030	F44003E12M030
PUR	0.6	F43001P12M006	F43003P12M006	F44001P12M006	F44003P12M006
	1.0	F43001P12M010	F43003P12M010	F44001P12M010	F44003P12M010
	2.0	F43001P12M020	F43003P12M020	F44001P12M020	F44003P12M020
	3.0	F43001P12M030	F43003P12M030	F44001P12M030	F44003P12M030

Form B Ind (11mm) 2 pole + 12 o'clock earth – 24 V LED & VDR

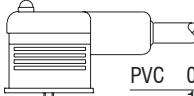
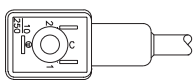

- 1 Brown
- 2 Blue
- 3 Yellow/Green*

Cable	Length (m)	Part No.	Part No.	Part No.	Part No.
PVC	0.6	F430B1E12M006	F430B3E12M006	F440B1E12M006	F440B3E12M006
	1.0	F430B1E12M010	F430B3E12M010	F440B1E12M010	F440B3E12M010
	2.0	F430B1E12M020	F430B3E12M020	F440B1E12M020	F440B3E12M020
	3.0	F430B1E12M030	F430B3E12M030	F440B1E12M030	F440B3E12M030
PUR	0.6	F430B1P12M006	F430B3P12M006	F440B1P12M006	F440B3P12M006
	1.0	F430B1P12M010	F430B3P12M010	F440B1P12M010	F440B3P12M010
	2.0	F430B1P12M020	F430B3P12M020	F440B1P12M020	F440B3P12M020
	3.0	F430B1P12M030	F430B3P12M030	F440B1P12M030	F440B3P12M030

* Yellow/Green not connected

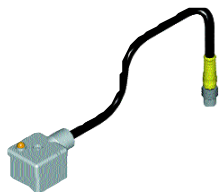

Female Connector

Cable

Length (m)

M8 3 Pole – Single I/O Multi-Port

M8 4 Pole – Twin I/O Multi-Port

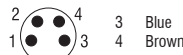
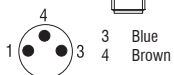
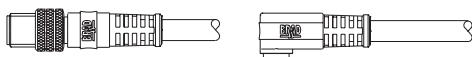

Form B Ind (11mm) 2 pole + 6 o'clock earth

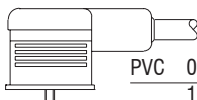
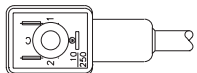

- 1 Brown
- 2 Blue
- 3 Yellow/Green*

	PVC	F43000E12M006	F43002E12M006	F44000E12M006	F44002E12M006
	0.6	F43000E12M006	F43002E12M006	F44000E12M006	F44002E12M006
	1.0	F43000E12M010	F43002E12M010	F44000E12M010	F44002E12M010
	2.0	F43000E12M020	F43002E12M020	F44000E12M020	F44002E12M020
	3.0	F43000E12M030	F43002E12M030	F44000E12M030	F44002E12M030
	PUR	F43000P12M006	F43002P12M006	F44000P12M006	F44002P12M006
	0.6	F43000P12M006	F43002P12M006	F44000P12M006	F44002P12M006
	1.0	F43000P12M010	F43002P12M010	F44000P12M010	F44002P12M010
	2.0	F43000P12M020	F43002P12M020	F44000P12M020	F44002P12M020
	3.0	F43000P12M030	F43002P12M030	F44000P12M030	F44002P12M030

Form B Ind (11mm) 2 pole + 6 o'clock earth – 24 V LED & VDR

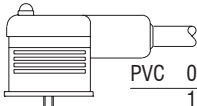
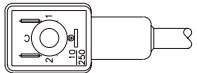

- 1 Brown
- 2 Blue
- 3 Yellow/Green*

	PVC	F430B0E12M006	F430B2E12M006	F440B0E12M006	F440B2E12M006
	0.6	F430B0E12M006	F430B2E12M006	F440B0E12M006	F440B2E12M006
	1.0	F430B0E12M010	F430B2E12M010	F440B0E12M010	F440B2E12M010
	2.0	F430B0E12M020	F430B2E12M020	F440B0E12M020	F440B2E12M020
	3.0	F430B0E12M030	F430B2E12M030	F440B0E12M030	F440B2E12M030
	PUR	F430B0P12M006	F430B2P12M006	F440B0P12M006	F440B2P12M006
	0.6	F430B0P12M006	F430B2P12M006	F440B0P12M006	F440B2P12M006
	1.0	F430B0P12M010	F430B2P12M010	F440B0P12M010	F440B2P12M010
	2.0	F430B0P12M020	F430B2P12M020	F440B0P12M020	F440B2P12M020
	3.0	F430B0P12M030	F430B2P12M030	F440B0P12M030	F440B2P12M030

Form B DIN (10mm) 2 pole + 12 o'clock earth

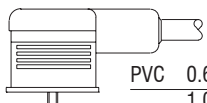
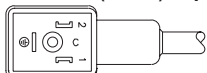

- 1 Brown
- 2 Blue
- 3 Yellow/Green*

	PVC	D43001E12M006	D43003E12M006	D44001E12M006	D44003E12M006
	0.6	D43001E12M006	D43003E12M006	D44001E12M006	D44003E12M006
	1.0	D43001E12M010	D43003E12M010	D44001E12M010	D44003E12M010
	2.0	D43001E12M020	D43003E12M020	D44001E12M020	D44003E12M020
	3.0	D43001E12M030	D43003E12M030	D44001E12M030	D44003E12M030
	PUR	D43001P12M006	D43003P12M006	D44001P12M006	D44003P12M006
	0.6	D43001P12M006	D43003P12M006	D44001P12M006	D44003P12M006
	1.0	D43001P12M010	D43003P12M010	D44001P12M010	D44003P12M010
	2.0	D43001P12M020	D43003P12M020	D44001P12M020	D44003P12M020
	3.0	D43001P12M030	D43003P12M030	D44001P12M030	D44003P12M030

Form B DIN (10mm) 2 pole + 12 o'clock earth – 24 V LED & VDR

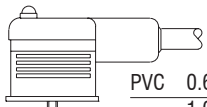
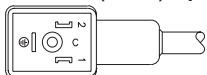

- 1 Brown
- 2 Blue
- 3 Yellow/Green*

	PVC	D430B1E12M006	D430B3E12M006	D440B1E12M006	D440B3E12M006
	0.6	D430B1E12M006	D430B3E12M006	D440B1E12M006	D440B3E12M006
	1.0	D430B1E12M010	D430B3E12M010	D440B1E12M010	D440B3E12M010
	2.0	D430B1E12M020	D430B3E12M020	D440B1E12M020	D440B3E12M020
	3.0	D430B1E12M030	D430B3E12M030	D440B1E12M030	D440B3E12M030
	PUR	D430B1P12M006	D430B3P12M006	D440B1P12M006	D440B3P12M006
	0.6	D430B1P12M006	D430B3P12M006	D440B1P12M006	D440B3P12M006
	1.0	D430B1P12M010	D430B3P12M010	D440B1P12M010	D440B3P12M010
	2.0	D430B1P12M020	D430B3P12M020	D440B1P12M020	D440B3P12M020
	3.0	D430B1P12M030	D430B3P12M030	D440B1P12M030	D440B3P12M030

* Yellow/Green not connected

Nano-Change® (M8) Jumper Cables

M8 3 Pole – Single I/O Multi-Port

M8 4 Pole – Twin I/O Multi-Port



Female Connector

Cable

Length (m)

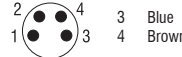
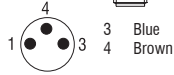
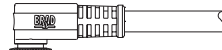
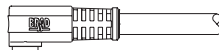

Form B DIN (10mm) 2 pole + 6 o'clock earth

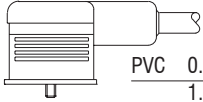
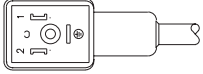

- 1 Brown
- 2 Blue
- 3 Yellow/Green*

Cable	Length (m)	D43000E12M006	D43002E12M006	D44000E12M006	D44002E12M006
PVC	0.6	D43000E12M006	D43002E12M006	D44000E12M006	D44002E12M006
	1.0	D43000E12M010	D43002E12M010	D44000E12M010	D44002E12M010
	2.0	D43000E12M020	D43002E12M020	D44000E12M020	D44002E12M020
	3.0	D43000E12M030	D43002E12M030	D44000E12M030	D44002E12M030
PUR	0.6	D43000P12M006	D43002P12M006	D44000P12M006	D44002P12M006
	1.0	D43000P12M010	D43002P12M010	D44000P12M010	D44002P12M010
	2.0	D43000P12M020	D43002P12M020	D44000P12M020	D44002P12M020
	3.0	D43000P12M030	D43002P12M030	D44000P12M030	D44002P12M030

Form B DIN (10mm) 2 pole + 6 o'clock earth – 24 V LED & VDR

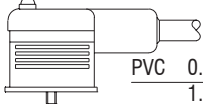
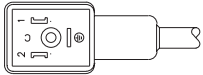

- 1 Brown
- 2 Blue
- 3 Yellow/Green*

Cable	Length (m)	D430B0E12M006	D430B2E12M006	D440B0E12M006	D440B2E12M006
PVC	0.6	D430B0E12M006	D430B2E12M006	D440B0E12M006	D440B2E12M006
	1.0	D430B0E12M010	D430B2E12M010	D440B0E12M010	D440B2E12M010
	2.0	D430B0E12M020	D430B2E12M020	D440B0E12M020	D440B2E12M020
	3.0	D430B0E12M030	D430B2E12M030	D440B0E12M030	D440B2E12M030
PUR	0.6	D430B0P12M006	D430B2P12M006	D440B0P12M006	D440B2P12M006
	1.0	D430B0P12M010	D430B2P12M010	D440B0P12M010	D440B2P12M010
	2.0	D430B0P12M020	D430B2P12M020	D440B0P12M020	D440B2P12M020
	3.0	D430B0P12M030	D430B2P12M030	D440B0P12M030	D440B2P12M030

Form C DIN (8mm) 2 pole + earth

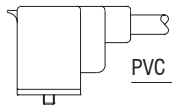
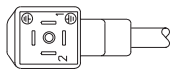

- 1 Brown
- 2 Blue
- 3 Yellow/Green*

Cable	Length (m)	H43000E12M006	H43002E12M006	H44000E12M006	H44002E12M006
PVC	0.6	H43000E12M006	H43002E12M006	H44000E12M006	H44002E12M006
	1.0	H43000E12M010	H43002E12M010	H44000E12M010	H44002E12M010
	2.0	H43000E12M020	H43002E12M020	H44000E12M020	H44002E12M020
	3.0	H43000E12M030	H43002E12M030	H44000E12M030	H44002E12M030
PUR	0.6	H43000P12M006	H43002P12M006	H44000P12M006	H44002P12M006
	1.0	H43000P12M010	H43002P12M010	H44000P12M010	H44002P12M010
	2.0	H43000P12M020	H43002P12M020	H44000P12M020	H44002P12M020
	3.0	H43000P12M030	H43002P12M030	H44000P12M030	H44002P12M030

Form C DIN (8mm) 2 pole + earth – 24 V LED & VDR

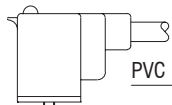
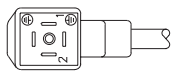

- 1 Brown
- 2 Blue
- 3 Yellow/Green*

* Yellow/Green not connected

Cable	Length (m)	H430B0E12M006	H430B2E12M006	H440B0E12M006	H440B2E12M006
PVC	0.6	H430B0E12M006	H430B2E12M006	H440B0E12M006	H440B2E12M006
	1.0	H430B0E12M010	H430B2E12M010	H440B0E12M010	H440B2E12M010
	2.0	H430B0E12M020	H430B2E12M020	H440B0E12M020	H440B2E12M020
	3.0	H430B0E12M030	H430B2E12M030	H440B0E12M030	H440B2E12M030
PUR	0.6	H430B0P12M006	H430B2P12M006	H440B0P12M006	H440B2P12M006
	1.0	H430B0P12M010	H430B2P12M010	H440B0P12M010	H440B2P12M010
	2.0	H430B0P12M020	H430B2P12M020	H440B0P12M020	H440B2P12M020
	3.0	H430B0P12M030	H430B2P12M030	H440B0P12M030	H440B2P12M030

Nano-Change® (M8) Jumper Cables

M8 3 Pole – Single I/O Multi-Port

M8 4 Pole – Twin I/O Multi-Port

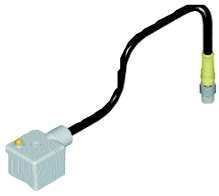

Female Connector

Cable

Length (m)

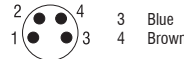
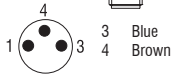

Form C Ind (9.4mm) 2 pole + earth

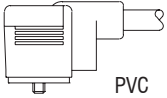
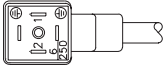

PVC	0.6	G43000E12M006	G43002E12M006	G44000E12M006	G44002E12M006
	1.0	G43000E12M010	G43002E12M010	G44000E12M010	G44002E12M010
1 Brown 2 Blue 3 Yellow/Green*	2.0	G43000E12M020	G43002E12M020	G44000E12M020	G44002E12M020
	3.0	G43000E12M030	G43002E12M030	G44000E12M030	G44002E12M030
PUR	0.6	G43000P12M006	G43002P12M006	G44000P12M006	G44002P12M006
	1.0	G43000P12M010	G43002P12M010	G44000P12M010	G44002P12M010
1 Brown 2 Blue 3 Yellow/Green*	2.0	G43000P12M020	G43002P12M020	G44000P12M020	G44002P12M020
	3.0	G43000P12M030	G43002P12M030	G44000P12M030	G44002P12M030

Form C Ind (9.4mm) 2 pole + earth – 24 V LED & VDR

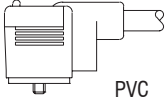
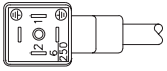

PVC	0.6	G430B0E12M006	G430B2E12M006	G440B0E12M006	G440B2E12M006
	1.0	G430B0E12M010	G430B2E12M010	G440B0E12M010	G440B2E12M010
1 Brown 2 Blue 3 Yellow/Green*	2.0	G430B0E12M020	G430B2E12M020	G440B0E12M020	G440B2E12M020
	3.0	G430B0E12M030	G430B2E12M030	G440B0E12M030	G440B2E12M030
PUR	0.6	G430B0P12M006	G430B2P12M006	G440B0P12M006	G440B2P12M006
	1.0	G430B0P12M010	G430B2P12M010	G440B0P12M010	G440B2P12M010
* Yellow/Green not connected	2.0	G430B0P12M020	G430B2P12M020	G440B0P12M020	G440B2P12M020
	3.0	G430B0P12M030	G430B2P12M030	G440B0P12M030	G440B2P12M030

Nano-Change (M8) Adapters and In-Line Splitters

M8 3 Pole – Single I/O Multi-Port

M8 4 Pole – Twin I/O Multi-Port

Female Connector



1 Brown 2 Blue 3 Black



1 Brown 2 White 3 Blue 4 Black

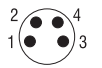

1 Brown 2 Black B 3 Blue 4 Black A

In-line splitter M8 to M8



1 Brown 2 Blue 3 Black 4 Black

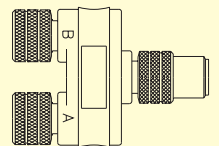

444A30

Adapter M12 to M8



1 Brown 2 White 3 Blue 4 Black

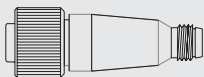

853030

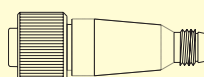

854030



M8 3 Pole – Single I/O Multi-Port

M8 4 Pole – Twin I/O Multi-Port

Female Connector

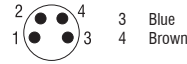

Circuit

WIRING CONFIGURATION

WIRING CONFIGURATION

Form A (18mm) 2 pole + earth

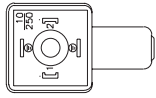

- 1 Brown
- 2 Blue

None
24 V LED & VDR

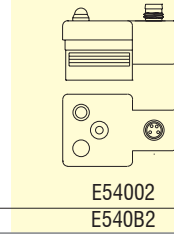
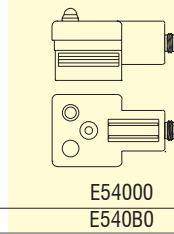
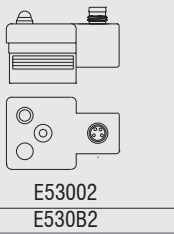
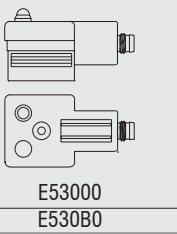

Form B (11mm) 2 pole + 12 o'clock earth

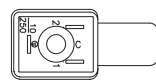

- 1 Brown
- 2 Blue

None
24 V LED & VDR

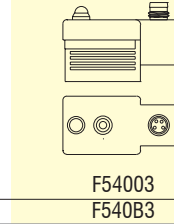
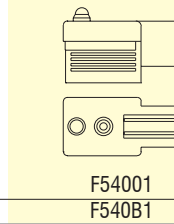
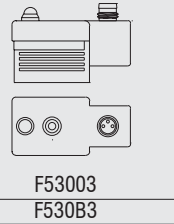
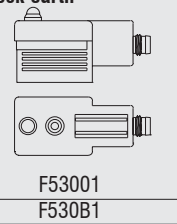

Form B (11mm) 2 pole + 6 o'clock earth

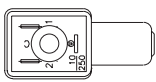

- 1 Brown
- 2 Blue

None
24 V LED & VDR

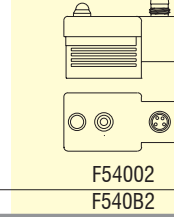
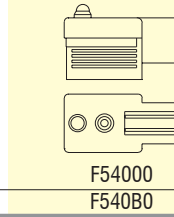
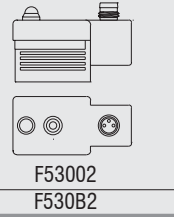
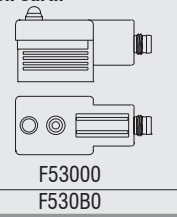

Form B (10mm) 2 pole + 12 o'clock earth

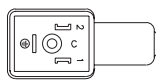

- 1 Brown
- 2 Blue

None
24 V LED & VDR

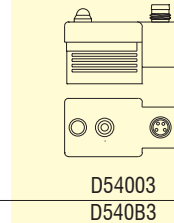
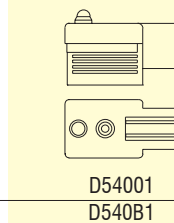
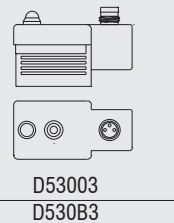
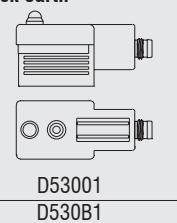

Form B (10mm) 2 pole + 6 o'clock earth

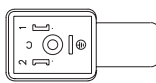

- 1 Brown
- 2 Blue

None
24 V LED & VDR

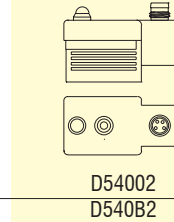
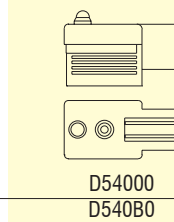
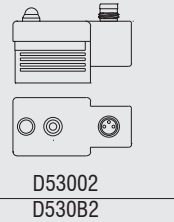
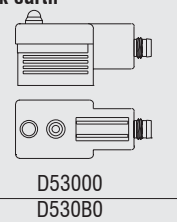

Form C (8mm) 2 pole + earth

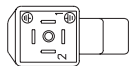

- 1 Brown
- 2 Blue

None
24 V LED & VDR

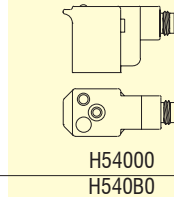
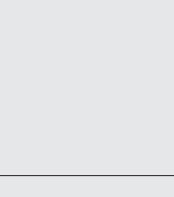
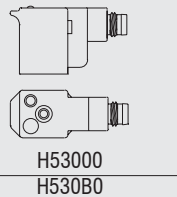

Form C (9.4mm) 2 pole + earth

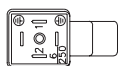

- 1 Brown
- 2 Blue

None
24 V LED & VDR

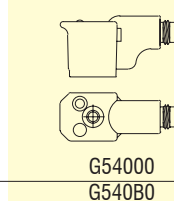
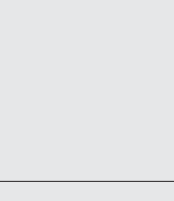
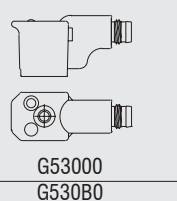

MICRO-CHANGE® MULTI-PORT SPLITTER BOX SYSTEMS

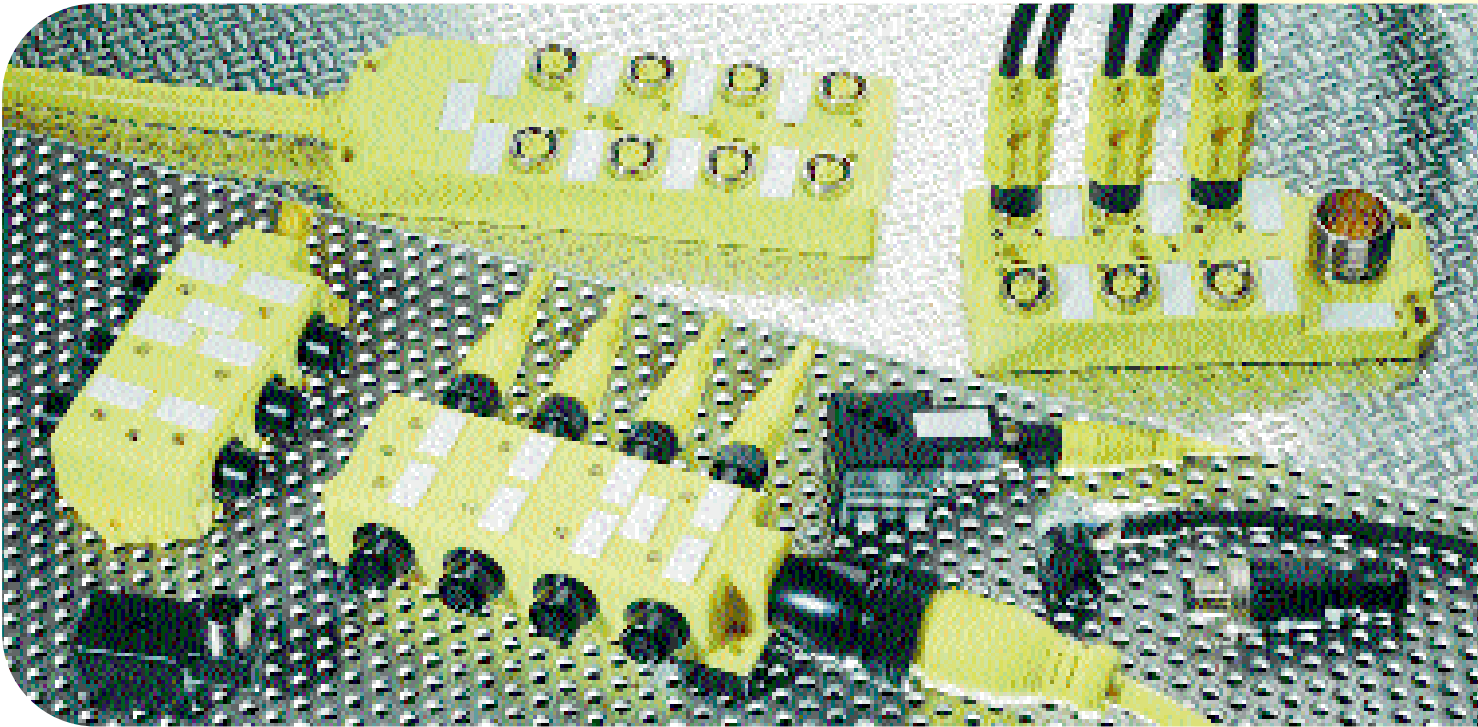

- **Frees up skilled workforce for more demanding tasks, whilst reducing the risk of wiring errors and increasing factory throughput**
- **Quick disconnect solution enables installation or maintenance by semiskilled operators, especially when unscheduled down time occurs through device or cable failure.**
- **Twin I/O versions increases the density of control devices per unit with LED indication of power and signals for fast fault finding**
- **Unique choice of either top or side mounted I/O connections for compact or low profile installations, all provided in a robust design sealed waterproof up to IP68**

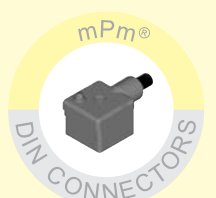

Micro-Change® (M12) Multi-Port Splitter Boxes

5 pole 4 Wire – Single I/O Top-Mount Multi-Ports

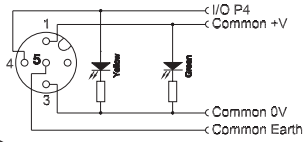
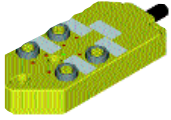

Function	Cable Colour	M23 Connector Pin No	Mini-Change Pin No	Function	Cable Colour	M23 Connector Pin No	Mini-Change Pin No
+V	Brown	11	10	Earth	Green/Yellow	12	9
0V	Blue	9 & 10	11				
Port 1 P4	White	1	1	Port 5 P4	Pink	5	5
Port 2 P4	Green	2	2	Port 6 P4	Red	6	6
Port 3 P4	Yellow	3	3	Port 7 P4	Black	7	7
Port 4 P4	Grey	4	4	Port 8 P4	Violet	8	8

Cable

Length (m)

Integral Cable Entry

4 Port

6 Port

8 Port

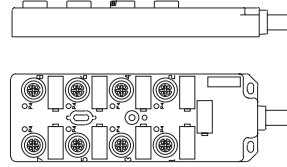
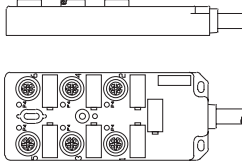
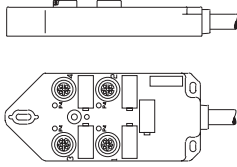

PVC	5.0	BTY400P-FBE-05	BTY600P-FBE-05	BTY800P-FBE-05
	10.0	BTY400P-FBE-10	BTY600P-FBE-10	BTY800P-FBE-10
	20.0	BTY400P-FBE-20	BTY600P-FBE-20	BTY800P-FBE-20
PUR	5.0	BTY400P-FBP-05	BTY600P-FBP-05	BTY800P-FBP-05
	10.0	BTY400P-FBP-10	BTY600P-FBP-10	BTY800P-FBP-10
	20.0	BTY400P-FBP-20	BTY600P-FBP-20	BTY800P-FBP-20

Integral M23 12 Pole Home Run Connector

4 Port

6 Port

8 Port

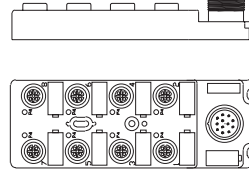
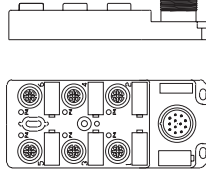
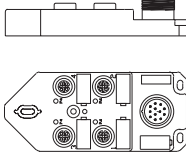

See top of page 19 for connectors

BTY401P-FBC

BTY601P-FBC

BTY801P-FBC

Integral Mini-Change® 12 Pole Home Run Connector

4 Port

6 Port

8 Port

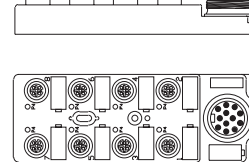
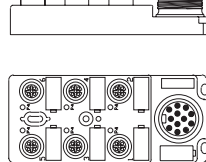
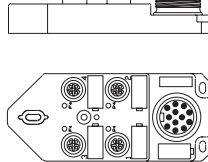

See top of page 20 for connectors

BTY401P-FBB

BTY601P-FBB

BTY801P-FBB

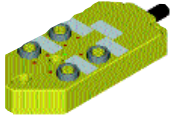

5 pole 5 Wire – Twin I/O Top-Mount Multi-Ports

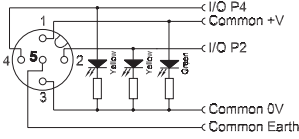

Function	Cable Colour	M23 Connector Pin No	Mini-Change Pin No	Attachable	Function	Cable Colour	M23 Connector Pin No	Mini-Change Pin No	Attachable
+V	Brown	19	7	17	Earth	Green/Yellow	12	12	19
0V	Blue	6	5	18					
Port 1 P4	White	15	15	1	Port 1 P2	Grey/Pink	7	19	9
Port 2 P4	Green	5	6	2	Port 2 P2	Red/Blue	4	4	10
Port 3 P4	Yellow	16	16	3	Port 3 P2	White/Green	8	8	11
Port 4 P4	Grey	3	3	4	Port 4 P2	Brown/Green	14	14	12
Port 5 P4	Pink	17	17	5	Port 5 P2	White/Yellow	9	9	13
Port 6 P4	Red	2	2	6	Port 6 P2	Yellow/Brown	13	13	14
Port 7 P4	Black	11	11	7	Port 7 P2	White/Grey	10	10	15
Port 8 P4	Violet	1	1	8	Port 8 P2	Grey/Brown	18	18	16

Cable

Length (m)

Integral Cable Entry

4 Port

6 Port

8 Port

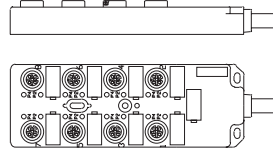
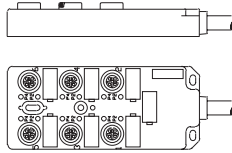
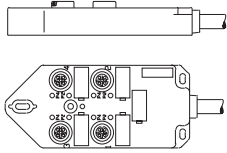

Cable	Length (m)	4 Port	6 Port	8 Port
PVC	5.0	BTY405P-FBE-05	BTY605P-FBE-05	BTY805P-FBE-05
	10.0	BTY405P-FBE-10	BTY605P-FBE-10	BTY805P-FBE-10
	20.0	BTY405P-FBE-20	BTY605P-FBE-20	BTY805P-FBE-20
PUR	5.0	BTY405P-FBP-05	BTY605P-FBP-05	BTY805P-FBP-05
	10.0	BTY405P-FBP-10	BTY605P-FBP-10	BTY805P-FBP-10
	20.0	BTY405P-FBP-20	BTY605P-FBP-20	BTY805P-FBP-20

Integral M23 19 Pole Home Run Connector

4 Port

6 Port

8 Port

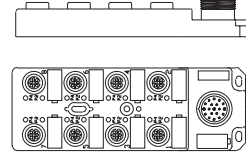
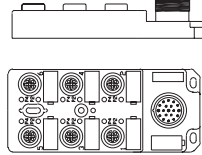
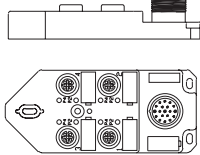

See bottom of page 19 for connectors

BTY403P-FBC

BTY603P-FBC

BTY803P-FBC

Integral Mini-Change® 19 Pole Home Run Connector

4 Port

6 Port

8 Port

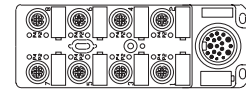
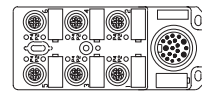
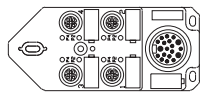

See bottom of page 20 for connectors

BTY403P-FBB

BTY603P-FBB

BTY803P-FBB

Field Attachables

4 Port

6 Port

8 Port

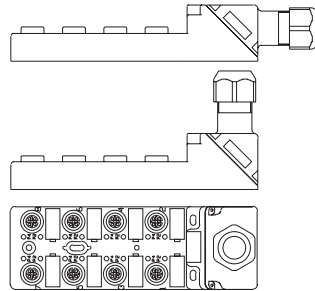
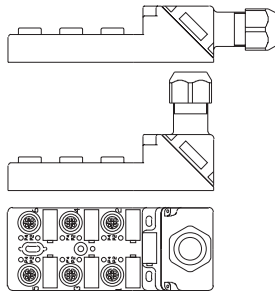
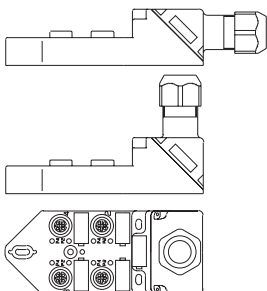

Includes removable cable terminals for ease of assembly

BTY403P-FBA

BTY603P-FBA

BTY803P-FBA

Standard: Power and two status LEDs per port, identification labels, two sealing caps
Options: NPN format LED indication, choice of cable see page 40 for more information

Micro-Change® (M12) Multi-Port Splitter Boxes

5 pole 3 Wire – Single I/O Side-Mount Multi-Ports

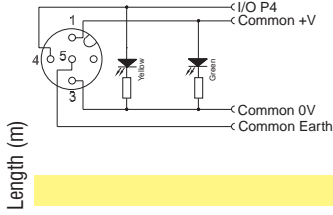

Function	Cable Colour	Mini-Change Pin No	Function	Cable Colour	Mini-Change Pin No
+V	Brown	10	Earth*	Green/Yellow	9
0V	Blue	11			
Port 1 P4	White	1	Port 5 P4	Pink	5
Port 2 P4	Green	2	Port 6 P4	Red	6
Port 3 P4	Yellow	3	Port 7 P4	Black	7
Port 4 P4	Grey	4	Port 8 P4	Violet	8

Standard: Power and single status LED per port, identification labels, two sealing caps
Options: NPN format LED indication, choice of cable see page 40 for more information

Cable

Length (m)

Integral Cable Entry

4 Port

6 Port

8 Port

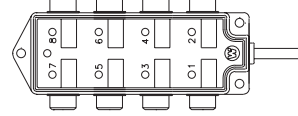
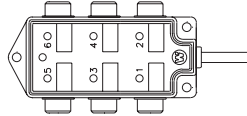
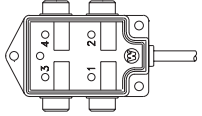
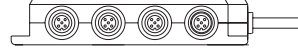
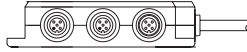

* Earth (pin 5) not connected on this model

PVC	5.0	BSY404P-FBE-05	BSY604P-FBE-05	BSY804P-FBE-05
	10.0	BSY404P-FBE-10	BSY604P-FBE-10	BSY804P-FBE-10
	20.0	BSY404P-FBE-20	BSY604P-FBE-20	BSY804P-FBE-20
PUR	5.0	BSY404P-FBP-05	BSY604P-FBP-05	BSY804P-FBP-05
	10.0	BSY404P-FBP-10	BSY604P-FBP-10	BSY804P-FBP-10
	20.0	BSY404P-FBP-20	BSY604P-FBP-20	BSY804P-FBP-20

Integral Mini-Change® 12 Pole Home Run Connector

4 Port

6 Port

8 Port



See top of page 20 for connectors

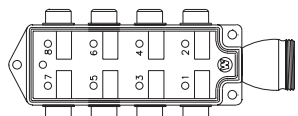
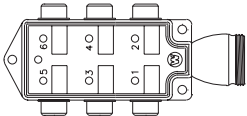
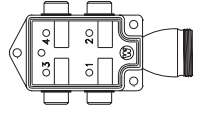
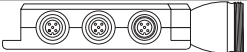
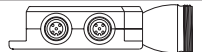

* Earth (pin 5) connected on this model

BSY401P-FBB

BSY601P-FBB

BSY801P-FBB

5 pole 5 Wire – Twin I/O Side-Mount Multi-Ports

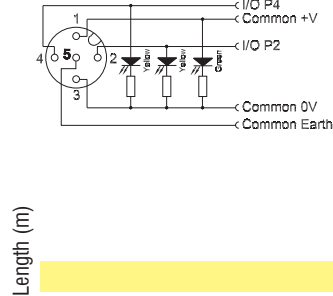

Function	Cable Colour	Mini-Change Pin No	Function	Cable Colour	Mini-Change Pin No
+V	Brown	7	Earth	Green/Yellow	12
0V	Blue	5			
Port 1 P4	White	15	Port 1 P2	Grey/Pink	19
Port 2 P4	Green	6	Port 2 P2	Red/Blue	4
Port 3 P4	Yellow	16	Port 3 P2	White/Green	8
Port 4 P4	Grey	3	Port 4 P2	Brown/Green	14
Port 5 P4	Pink	17	Port 5 P2	White/Yellow	9
Port 6 P4	Red	2	Port 6 P2	Yellow/Brown	13
Port 7 P4	Black	11	Port 7 P2	White/Grey	10
Port 8 P4	Violet	1	Port 8 P2	Grey/Brown	18

Standard: Power and two status LED per port, identification labels, two sealing caps
Options: NPN format LED indication, choice of cable see page 40 for more information

Cable

Length (m)

Integral Cable Entry

4 Port

6 Port

8 Port

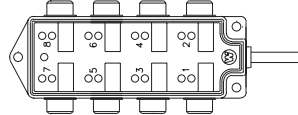
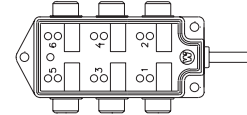
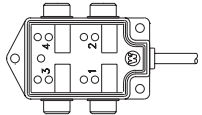
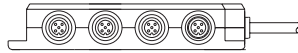
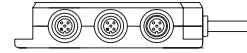
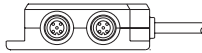

PVC	5.0	BSY403P-FBE-05	BSY603P-FBE-05	BSY803P-FBE-05
	10.0	BSY403P-FBE-10	BSY603P-FBE-10	BSY803P-FBE-10
	20.0	BSY403P-FBE-20	BSY603P-FBE-20	BSY803P-FBE-20
PUR	5.0	BSY403P-FBP-05	BSY603P-FBP-05	BSY803P-FBP-05
	10.0	BSY403P-FBP-10	BSY603P-FBP-10	BSY803P-FBP-10
	20.0	BSY403P-FBP-20	BSY603P-FBP-20	BSY803P-FBP-20

Integral Mini-Change® 18 Pole Home Run Connector

4 Port

6 Port

8 Port

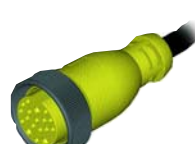

See top of page 20 for connectors

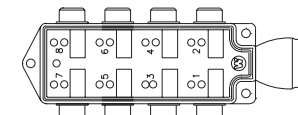
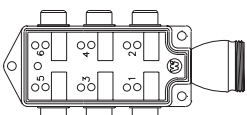
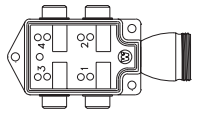
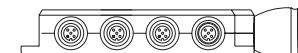
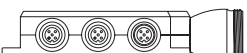
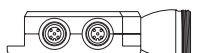

BSY403P-FBB

BSY603P-FBB

BSY803P-FBB

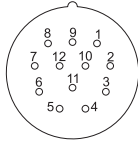

Female Connector Face View

Function	M23 Connector Pin No	Cable Colour	Function	M23 Connector Pin No	Cable Colour
+V	11	Brown	Earth	12	Green/Yellow
0V	9 & 10	Blue			
Port 1 P4	1	White	Port 5 P4	5	Pink
Port 2 P4	2	Green	Port 6 P4	6	Red
Port 3 P4	3	Yellow	Port 7 P4	7	Black
Port 4 P4	4	Grey	Port 8 P4	8	Violet

Female Connector

Cable Length (m)

M23 12 Pole Moulded Connector

M23 Straight

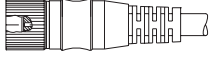

		BTY401P-FBC 5 Pole/4 Wire - 4 Port	BTY601P-FBC 5 Pole/4 Wire - 6 Port	BTY801P-FBC 5 Pole/4 Wire - 8 Port		
PVC	5.0	K02300E80M050	K02200E80M050	K02100E80M050		
	10.0	K02300E80M100	K02200E80M100	K02100E80M100		
	20.0	K02300E80M200	K02200E80M200	K02100E80M200		
PUR	5.0	K02300P80M050	K02200P80M050	K02100P80M050		
	10.0	K02300P80M100	K02200P80M100	K02100P80M100		
	20.0	K02300P80M200	K02200P80M200	K02100P80M200		

M23 90°

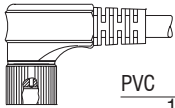

PVC	5.0	K02301E80M050	K02201E80M050	K02101E80M050		
	10.0	K02301E80M100	K02201E80M100	K02101E80M100		
	20.0	K02301E80M200	K02201E80M200	K02101E80M200		
PUR	5.0	K02301P80M050	K02201P80M050	K02101P80M050		
	10.0	K02301P80M100	K02201P80M100	K02101P80M100		
	20.0	K02301P80M200	K02201P80M200	K02101P80M200		

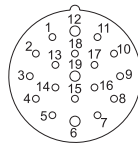

Female Connector Face View

Function	M23 Connector Pin No	Cable Colour	Function	M23 Connector Pin No	Cable Colour
+V	19	Brown	Earth	12	Green/Yellow
0V	6	Blue			
Port 1 P4	15	White	Port 1 P2	7	Grey/Pink
Port 2 P4	5	Green	Port 2 P2	4	Red/Blue
Port 3 P4	16	Yellow	Port 3 P2	8	White/Green
Port 4 P4	3	Grey	Port 4 P2	14	Brown/Green
Port 5 P4	17	Pink	Port 5 P2	9	White/Yellow
Port 6 P4	2	Red	Port 6 P2	13	Yellow/Brown
Port 7 P4	11	Black	Port 7 P2	10	White/Grey
Port 8 P4	1	Violet	Port 8 P2	18	Grey/Brown

M23 19 Pole Moulded Connector

M23 Straight

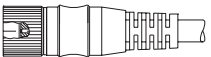

		BTY403P-FBC 5 Pole/5 Wire - 4 Port	BTY603P-FBC 5 Pole/5 Wire - 6 Port	BTY803P-FBC 5 Pole/5 Wire - 8 Port		
PVC	5.0	K03300E80M050	K03200E80M050	K03000E80M050		
	10.0	K03300E80M100	K03200E80M100	K03000E80M100		
	20.0	K03300E80M200	K03200E80M200	K03000E80M200		
PUR	5.0	K03300P80M050	K03200P80M050	K03000P80M050		
	10.0	K03300P80M100	K03200P80M100	K03000P80M100		
	20.0	K03300P80M200	K03200P80M200	K03000P80M200		

M23 90°

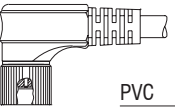

PVC	5.0	K03301E80M050	K03201E80M050	K03001E80M050		
	10.0	K03301E80M100	K03201E80M100	K03001E80M100		
	20.0	K03301E80M200	K03201E80M200	K03001E80M200		
PUR	5.0	K03301P80M050	K03201P80M050	K03001P80M050		
	10.0	K03301P80M100	K03201P80M100	K03001P80M100		
	20.0	K03301P80M200	K03201P80M200	K03001P80M200		

Home Run Connectors for Micro-Change® Multi-Port Splitter Boxes



Female Connector

Cable Length (m)

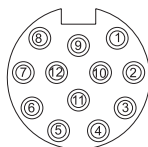

Female Connector Face View

Function	Mini-Change Pin No	Cable Colour	Function	Mini-Change Pin No	Cable Colour
+V	10	Brown	Earth	9	Green/Yellow
0V	11	Blue			
Port 1 P4	1	White	Port 5 P4	5	Pink
Port 2 P4	2	Green	Port 6 P4	6	Red
Port 3 P4	3	Yellow	Port 7 P4	7	Black
Port 4 P4	4	Grey	Port 8 P4	8	Violet

Mini-Change® 12 pole Moulded Connector

Mini-Change® Straight

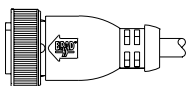

		BTY401P-FBB BSY401P-FBB 5 Pole/4 Wire - 4 Port	BTY601P-FBB BSY601P-FBB 5 Pole/4 Wire - 6 Port	BTY801P-FBB BSY801P-FBB 5 Pole/4 Wire - 8 Port		
PVC	5.0	302300E80M050	302200E80M050	302100E80M050		
	10.0	302300E80M100	302200E80M100	302100E80M100		
	20.0	302300E80M200	302200E80M200	302100E80M200		
PUR	5.0	302300P80M050	302200P80M050	302100P80M050		
	10.0	302300P80M100	302200P80M100	302100P80M100		
	20.0	302300P80M200	302200P80M200	302100P80M200		

Mini-Change® 90°

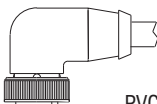

PVC	5.0	302301E80M050	302201E80M050	302101E80M050		
	10.0	302301E80M100	302201E80M100	302101E80M100		
	20.0	302301E80M200	302201E80M200	302101E80M200		
PUR	5.0	302301P80M050	302201P80M050	302101P80M050		
	10.0	302301P80M100	302201P80M100	302101P80M100		
	20.0	302301P80M200	302201P80M200	302101P80M200		

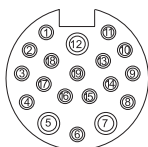

Female Connector Face View

Function	Mini-Change Pin No	Cable Colour	Function	Mini-Change Pin No	Cable Colour
+V	7	Brown	Earth	12	Green/Yellow
0V	5	Blue			
Port 1 P4	15	White	Port 1 P2	19	Grey/Pink
Port 2 P4	6	Green	Port 2 P2	4	Red/Blue
Port 3 P4	16	Yellow	Port 3 P2	8	White/Green
Port 4 P4	3	Grey	Port 4 P2	14	Brown/Green
Port 5 P4	17	Pink	Port 5 P2	9	White/Yellow
Port 6 P4	2	Red	Port 6 P2	13	Yellow/Brown
Port 7 P4	11	Black	Port 7 P2	10	White/Grey
Port 8 P4	1	Violet	Port 8 P2	18	Grey/Brown

Mini-Change® 19 pole Moulded Connector

Mini-Change® Straight

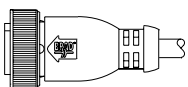

		BTY403P-FBB BSY403P-FBB 5 Pole/5 Wire - 4 Port	BTY603P-FBB BSY603P-FBB 5 Pole/5 Wire - 6 Port	BTY803P-FBB BSY803P-FBB 5 Pole/5 Wire - 8 Port		
PVC	5.0	303300E80M050	303200E80M050	303000E80M050		
	10.0	303300E80M100	303200E80M100	303000E80M100		
	20.0	303300E80M200	303200E80M200	303000E80M200		
PUR	5.0	303300P80M050	303200P80M050	303000P80M050		
	10.0	303300P80M100	303200P80M100	303000P80M100		
	20.0	303300P80M200	303200P80M200	303000P80M200		

Mini-Change® 90°

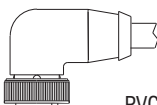

PVC	5.0	303301E80M050	303201E80M050	303001E80M050		
	10.0	303301E80M100	303201E80M100	303001E80M100		
	20.0	303301E80M200	303201E80M200	303001E80M200		
PUR	5.0	303301P80M050	303201P80M050	303001P80M050		
	10.0	303301P80M100	303201P80M100	303001P80M100		
	20.0	303301P80M200	303201P80M200	303001P80M200		

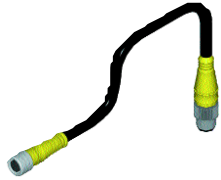

Female Connector

Cable

Length (m)

M12 Single I/O Multi-Port

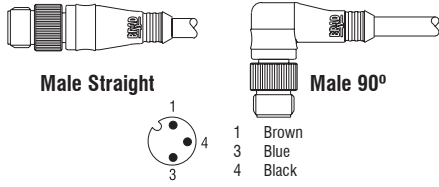

WIRING CONFIGURATION

M12 Twin I/O Multi-Port

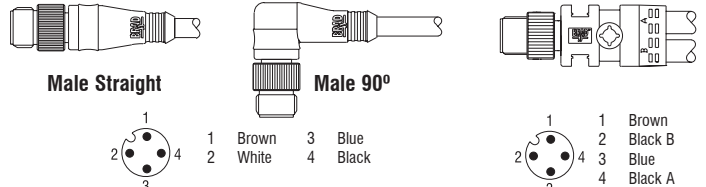

WIRING CONFIGURATION

Nano-Change® (M8) Straight



- 1 Brown
- 3 Blue
- 4 Black

PVC	0.6	483030E03M006	483032E03M006
	1.0	483030E03M010	483032E03M010
PUR	0.6	483030P03M006	483032P03M006
	1.0	483030P03M010	483032P03M010
	2.0	483030P03M020	483032P03M020
	3.0	483030P03M030	483032P03M030

Nano-Change® (M8) 90°

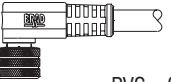

- Pin No. Wire
- 1 Brown
- 3 Blue
- 4 Black

PVC	0.6	483031E03M006	483033E03M006
	1.0	483031E03M010	483033E03M010
PUR	0.6	483031P03M006	483033P03M006
	1.0	483031P03M010	483033P03M010
	2.0	483031P03M020	483033P03M020
	3.0	483031P03M030	483033P03M030

Also compatible with Twin I/O Multi-Ports

Nano-Change® (M8) 90° PNP LED

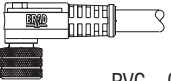

- 1 Brown
- 3 Blue
- 4 Black

PVC	0.6	4830P7E03M006	4830P9E03M006
	1.0	4830P7E03M010	4830P9E03M010
PUR	0.6	4830P7P03M006	4830P9P03M006
	1.0	4830P7P03M010	4830P9P03M010
	2.0	4830P7P03M020	4830P9P03M020
	3.0	4830P7P03M030	4830P9P03M030

Nano-Change® (M8) Straight



- 1 Brown
- 2 White*
- 3 Blue
- 4 Black

PVC	0.6	484030E03M006	484032E03M006
	1.0	484030E03M010	484032E03M010
PUR	0.6	484030P03M006	484032P03M006
	1.0	484030P03M010	484032P03M010
	2.0	484030P03M020	484032P03M020
	3.0	484030P03M030	484032P03M030

Nano-Change® (M8) 90°

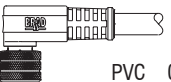

- 1 Brown
- 2 White*
- 3 Blue
- 4 Black

PVC	0.6	484031E03M006	484033E03M006
	1.0	484031E03M010	484033E03M010
PUR	0.6	484031P03M006	484033P03M006
	1.0	484031P03M010	484033P03M010
	2.0	484031P03M020	484033P03M020
	3.0	484031P03M030	484033P03M030

Also compatible with Single I/O Multi-Ports

* White not used on in-line splitter connectors

Options: NPN format LED indication, choice of cable and coupling materials, see page 40 for more information

Micro-Change® (M12) Jumper Cables

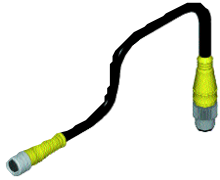

Female Connector

Cable

Length (m)

M12 Single I/O Multi-Port

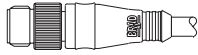

Male Straight

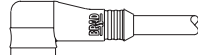

Male 90°



- 1 Brown
- 2 Blue
- 3 Black
- 4 Black

WIRING CONFIGURATION

M12 Twin I/O Multi-Port

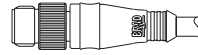

Male Straight

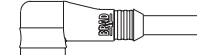

Male 90°



- 1 Brown
- 2 White
- 3 Blue
- 4 Black

WIRING CONFIGURATION

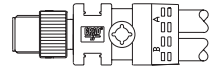

- 1 Brown
- 2 Black B
- 3 Blue
- 4 Black A

Micro-Change® (M12) Straight

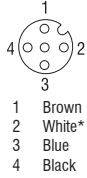

Material	Length (m)	Part Number 1	Part Number 2	Part Number 3	Part Number 4
PVC	0.6	883030E03M006	883032E03M006	884030E03M006	884032E03M006
	1.0	883030E03M010	883032E03M010	884030E03M010	884032E03M010
	2.0	883030E03M020	883032E03M020	884030E03M020	884032E03M020
	3.0	883030E03M030	883032E03M030	884030E03M030	884032E03M030
PUR	0.6	883030P03M006	883032P03M006	884030P03M006	884032P03M006
	1.0	883030P03M010	883032P03M010	884030P03M010	884032P03M010
	2.0	883030P03M020	883032P03M020	884030P03M020	884032P03M020
	3.0	883030P03M030	883032P03M030	884030P03M030	884032P03M030

Micro-Change® (M12) 90°

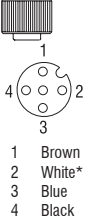

Material	Length (m)	Part Number 1	Part Number 2	Part Number 3	Part Number 4
PVC	0.6	883031E03M006	883033E03M006	884031E03M006	884033E03M006
	1.0	883031E03M010	883033E03M010	884031E03M010	884033E03M010
	2.0	883031E03M020	883033E03M020	884031E03M020	884033E03M020
	3.0	883031E03M030	883033E03M030	884031E03M030	884033E03M030
PUR	0.6	883031P03M006	883033P03M006	884031P03M006	884033P03M006
	1.0	883031P03M010	883033P03M010	884031P03M010	884033P03M010
	2.0	883031P03M020	883033P03M020	884031P03M020	884033P03M020
	3.0	883031P03M030	883033P03M030	884031P03M030	884033P03M030

Micro-Change® (M12) PNP LED



Material	Length (m)	Part Number 1	Part Number 2	Part Number 3	Part Number 4
PVC	0.6	8830P6E03M006	8830P8E03M006	8840P6E03M006	8840P8E03M006
	1.0	8830P6E03M010	8830P8E03M010	8840P6E03M010	8840P8E03M010
	2.0	8830P6E03M020	8830P8E03M020	8840P6E03M020	8840P8E03M020
	3.0	8830P6E03M030	8830P8E03M030	8840P6E03M030	8840P8E03M030
PUR	0.6	8830P6P03M006	8830P8P03M006	8840P6P03M006	8840P8P03M006
	1.0	8830P6P03M010	8830P8P03M010	8840P6P03M010	8840P8P03M010
	2.0	8830P6P03M020	8830P8P03M020	8840P6P03M020	8840P8P03M020
	3.0	8830P6P03M030	8830P8P03M030	8840P6P03M030	8840P8P03M030

Micro-Change® (M12) 90° PNP LED

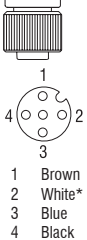
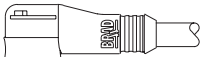

Material	Length (m)	Part Number 1	Part Number 2	Part Number 3	Part Number 4
PVC	0.6	8830P7E03M006	8830P9E03M006	8840P7E03M006	8840P9E03M006
	1.0	8830P7E03M010	8830P9E03M010	8840P7E03M010	8840P9E03M010
	2.0	8830P7E03M020	8830P9E03M020	8840P7E03M020	8840P9E03M020
	3.0	8830P7E03M030	8830P9E03M030	8840P7E03M030	8840P9E03M030
PUR	0.6	8830P7P03M006	8830P9P03M006	8840P7P03M006	8840P9P03M006
	1.0	8830P7P03M010	8830P9P03M010	8840P7P03M010	8840P9P03M010
	2.0	8830P7P03M020	8830P9P03M020	8840P7P03M020	8840P9P03M020
	3.0	8830P7P03M030	8830P9P03M030	8840P7P03M030	8840P9P03M030

* White not used on Single I/O and in-line splitter connectors

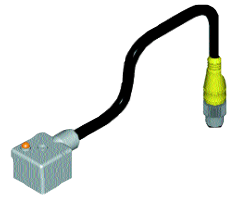

Female Connector

Cable

Length (m)

M12 Single I/O Multi-Port



Male Straight

Male 90°

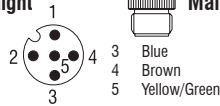

WIRING CONFIGURATION

M12 Twin I/O Multi-Port

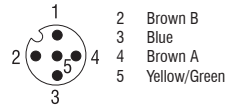
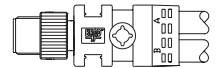

WIRING CONFIGURATION

Form A (18mm) 2 pole + earth

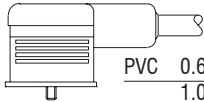
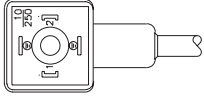

- 1 Brown
- 2 Blue
- 3 Yellow/Green

Material	Length (m)	Part Number 1	Part Number 2	Part Number 3
PVC	0.6	E85000E12M006	E85002E12M006	E85A00E12M006
	1.0	E85000E12M010	E85002E12M010	E85A00E12M010
	2.0	E85000E12M020	E85002E12M020	E85A00E12M020
PUR	0.6	E85000P12M006	E85002P12M006	E85A00P12M006
	1.0	E85000P12M010	E85002P12M010	E85A00P12M010
	2.0	E85000P12M020	E85002P12M020	E85A00P12M020
PUR	3.0	E85000P12M030	E85002P12M030	E85A00P12M030

Form A (18mm) 2 pole + earth – 24 V LED & VDR

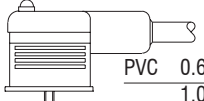
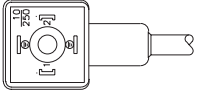

- 1 Brown
- 2 Blue
- 3 Yellow/Green

Material	Length (m)	Part Number 1	Part Number 2	Part Number 3
PVC	0.6	E850B0E12M006	E850B2E12M006	E85AB0E12M006
	1.0	E850B0E12M010	E850B2E12M010	E85AB0E12M010
	2.0	E850B0E12M020	E850B2E12M020	E85AB0E12M020
	3.0	E850B0E12M030	E850B2E12M030	E85AB0E12M030
PUR	0.6	E850B0P12M006	E850B2P12M006	E85AB0P12M006
	1.0	E850B0P12M010	E850B2P12M010	E85AB0P12M010
	2.0	E850B0P12M020	E850B2P12M020	E85AB0P12M020
	3.0	E850B0P12M030	E850B2P12M030	E85AB0P12M030

Form B Ind (11mm) 2 pole + 12 o'clock earth

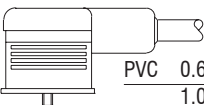
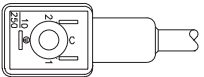

- 1 Brown
- 2 Blue
- 3 Yellow/Green

Material	Length (m)	Part Number 1	Part Number 2	Part Number 3
PVC	0.6	F85001E12M006	F85003E12M006	F85A01E12M006
	1.0	F85001E12M010	F85003E12M010	F85A01E12M010
	2.0	F85001E12M020	F85003E12M020	F85A01E12M020
	3.0	F85001E12M030	F85003E12M030	F85A01E12M030
PUR	0.6	F85001P12M006	F85003P12M006	F85A01P12M006
	1.0	F85001P12M010	F85003P12M010	F85A01P12M010
	2.0	F85001P12M020	F85003P12M020	F85A01P12M020
	3.0	F85001P12M030	F85003P12M030	F85A01P12M030

Also compatible with Twin I/O Multi-Ports

Form B Ind (11mm) 2 pole + 12 o'clock earth – 24 V LED & VDR

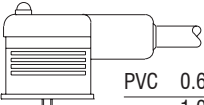
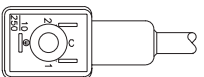

- 1 Brown
- 2 Blue
- 3 Yellow/Green

Material	Length (m)	Part Number 1	Part Number 2	Part Number 3
PVC	0.6	F850B1E12M006	F850B3E12M006	F85AB1E12M006
	1.0	F850B1E12M010	F850B3E12M010	F85AB1E12M010
	2.0	F850B1E12M020	F850B3E12M020	F85AB1E12M020
	3.0	F850B1E12M030	F850B3E12M030	F85AB1E12M030
PUR	0.6	F850B1P12M006	F850B3P12M006	F85AB1P12M006
	1.0	F850B1P12M010	F850B3P12M010	F85AB1P12M010
	2.0	F850B1P12M020	F850B3P12M020	F85AB1P12M020
	3.0	F850B1P12M030	F850B3P12M030	F85AB1P12M030

Micro-Change® (M12) Jumper Cables

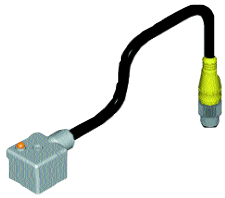

Female Connector

Cable Length (m)

M12 Single I/O Multi-Port

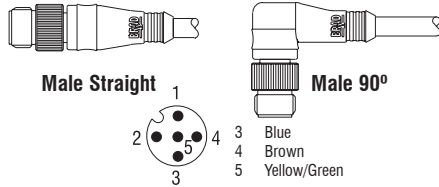

WIRING CONFIGURATION

M12 Twin I/O Multi-Port

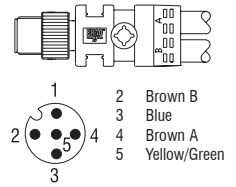

WIRING CONFIGURATION

Form B Ind (11mm) 2 pole + 6 o'clock earth

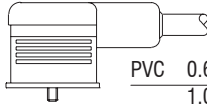
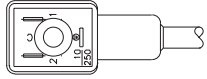

- 1 Brown
- 2 Blue
- 3 Yellow/Green

Material	Length (m)	Part Number 1	Part Number 2	Part Number 3
PVC	0.6	F85000E12M006	F85002E12M006	F85A00E12M006
	1.0	F85000E12M010	F85002E12M010	F85A00E12M010
	2.0	F85000E12M020	F85002E12M020	F85A00E12M020
	3.0	F85000E12M030	F85002E12M030	F85A00E12M030
PUR	0.6	F85000P12M006	F85002P12M006	F85A00P12M006
	1.0	F85000P12M010	F85002P12M010	F85A00P12M010
	2.0	F85000P12M020	F85002P12M020	F85A00P12M020
	3.0	F85000P12M030	F85002P12M030	F85A00P12M030

Form B Ind (11mm) 2 pole + 6 o'clock earth – 24 V LED & VDR

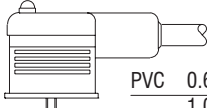
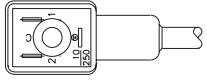

- 1 Brown
- 2 Blue
- 3 Yellow/Green

Material	Length (m)	Part Number 1	Part Number 2	Part Number 3
PVC	0.6	F850B0E12M006	F850B2E12M006	F85AB0E12M006
	1.0	F850B0E12M010	F850B2E12M010	F85AB0E12M010
	2.0	F850B0E12M020	F850B2E12M020	F85AB0E12M020
	3.0	F850B0E12M030	F850B2E12M030	F85AB0E12M030
PUR	0.6	F850B0P12M006	F850B2P12M006	F85AB0P12M006
	1.0	F850B0P12M010	F850B2P12M010	F85AB0P12M010
	2.0	F850B0P12M020	F850B2P12M020	F85AB0P12M020
	3.0	F850B0P12M030	F850B2P12M030	F85AB0P12M030

Form B DIN (10mm) 2 pole + 12 o'clock earth

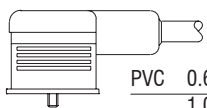
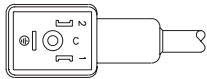

- 1 Brown
- 2 Blue
- 3 Yellow/Green

Material	Length (m)	Part Number 1	Part Number 2	Part Number 3
PVC	0.6	D85001E12M006	D85003E12M006	D85A01E12M006
	1.0	D85001E12M010	D85003E12M010	D85A01E12M010
	2.0	D85001E12M020	D85003E12M020	D85A01E12M020
	3.0	D85001E12M030	D85003E12M030	D85A01E12M030
PUR	0.6	D85001P12M006	D85003P12M006	D85A01P12M006
	1.0	D85001P12M010	D85003P12M010	D85A01P12M010
	2.0	D85001P12M020	D85003P12M020	D85A01P12M020
	3.0	D85001P12M030	D85003P12M030	D85A01P12M030

Also compatible with Twin I/O Multi-Ports

Form B DIN (10mm) 2 pole + 12 o'clock earth – 24 V LED & VDR

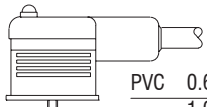
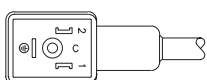

- 1 Brown
- 2 Blue
- 3 Yellow/Green

Material	Length (m)	Part Number 1	Part Number 2	Part Number 3
PVC	0.6	D850B1E12M006	D850B3E12M006	D85AB1E12M006
	1.0	D850B1E12M010	D850B3E12M010	D85AB1E12M010
	2.0	D850B1E12M020	D850B3E12M020	D85AB1E12M020
	3.0	D850B1E12M030	D850B3E12M030	D85AB1E12M030
PUR	0.6	D850B1P12M006	D850B3P12M006	D85AB1P12M006
	1.0	D850B1P12M010	D850B3P12M010	D85AB1P12M010
	2.0	D850B1P12M020	D850B3P12M020	D85AB1P12M020
	3.0	D850B1P12M030	D850B3P12M030	D85AB1P12M030

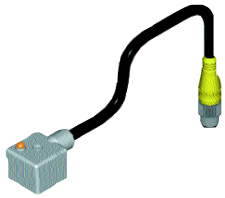

Female Connector

Cable

Length (m)

M12 Single I/O Multi-Port



Male Straight

Male 90°

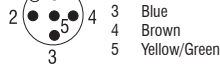

WIRING CONFIGURATION

M12 Twin I/O Multi-Port

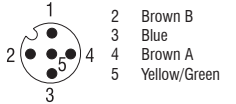
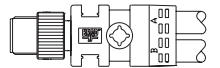

WIRING CONFIGURATION

Form B DIN (10mm) 2 pole + 6 o'clock earth

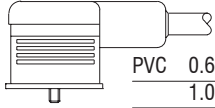
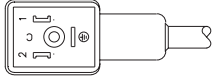

- 1 Brown
- 2 Blue
- 3 Yellow/Green

Cable	Length (m)	Material	Part No.	Part No.	Part No.
PVC	0.6		D85000E12M006	D85002E12M006	D85A00E12M006
	1.0		D85000E12M010	D85002E12M010	D85A00E12M010
	2.0		D85000E12M020	D85002E12M020	D85A00E12M020
	3.0		D85000E12M030	D85002E12M030	D85A00E12M030
PUR	0.6		D85000P12M006	D85002P12M006	D85A00P12M006
	1.0		D85000P12M010	D85002P12M010	D85A00P12M010
	2.0		D85000P12M020	D85002P12M020	D85A00P12M020
	3.0		D85000P12M030	D85002P12M030	D85A00P12M030

Form B DIN (10mm) 2 pole + 6 o'clock earth – 24 V LED & VDR

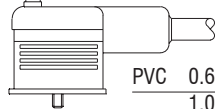
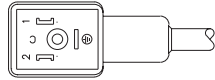

- 1 Brown
- 2 Blue
- 3 Yellow/Green

Cable	Length (m)	Material	Part No.	Part No.	Part No.
PVC	0.6		D850B0E12M006	D850B2E12M006	D85AB0E12M006
	1.0		D850B0E12M010	D850B2E12M010	D85AB0E12M010
	2.0		D850B0E12M020	D850B2E12M020	D85AB0E12M020
	3.0		D850B0E12M030	D850B2E12M030	D85AB0E12M030
PUR	0.6		D850B0P12M006	D850B2P12M006	D85AB0P12M006
	1.0		D850B0P12M010	D850B2P12M010	D85AB0P12M010
	2.0		D850B0P12M020	D850B2P12M020	D85AB0P12M020
	3.0		D850B0P12M030	D850B2P12M030	D85AB0P12M030

Form C DIN (8mm) 2 pole + earth

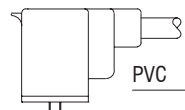
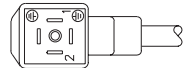

- 1 Brown
- 2 Blue
- 3 Yellow/Green

Cable	Length (m)	Material	Part No.	Part No.	Part No.
PVC	0.6		H85000E12M006	H85002E12M006	H85A00E12M006
	1.0		H85000E12M010	H85002E12M010	H85A00E12M010
	2.0		H85000E12M020	H85002E12M020	H85A00E12M020
	3.0		H85000E12M030	H85002E12M030	H85A00E12M030
PUR	0.6		H85000P12M006	H85002P12M006	H85A00P12M006
	1.0		H85000P12M010	H85002P12M010	H85A00P12M010
	2.0		H85000P12M020	H85002P12M020	H85A00P12M020
	3.0		H85000P12M030	H85002P12M030	H85A00P12M030

Also compatible with Twin I/O Multi-Ports

Form C DIN (8mm) 2 pole + earth – 24 V LED & VDR

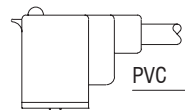
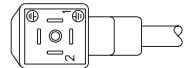

- 1 Brown
- 2 Blue
- 3 Yellow/Green

Cable	Length (m)	Material	Part No.	Part No.	Part No.
PVC	0.6		H850B0E12M006	H850B2E12M006	H85AB0E12M006
	1.0		H850B0E12M010	H850B2E12M010	H85AB0E12M010
	2.0		H850B0E12M020	H850B2E12M020	H85AB0E12M020
	3.0		H850B0E12M030	H850B2E12M030	H85AB0E12M030
PUR	0.6		H850B0P12M006	H850B2P12M006	H85AB0P12M006
	1.0		H850B0P12M010	H850B2P12M010	H85AB0P12M010
	2.0		H850B0P12M020	H850B2P12M020	H85AB0P12M020
	3.0		H850B0P12M030	H850B2P12M030	H85AB0P12M030

Micro-Change® (M12) Jumper Cables

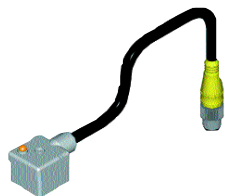

Female Connector

Cable

Length (m)

M12 Single I/O Multi-Port Jumpers



Male Straight

Male 90°



- 3 Blue
- 4 Brown
- 5 Yellow/Green

WIRING CONFIGURATION

M12 Twin I/O Multi-Port Jumpers



- 2 Brown B
- 3 Blue
- 4 Brown A
- 5 Yellow/Green

WIRING CONFIGURATION

Form C Ind (9.4mm) 2 pole + earth

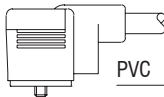
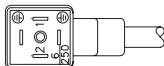

PVC

0.6

G85000E12M006

G85002E12M006

1.0

G85000E12M010

G85002E12M010

2.0

G85000E12M020

G85002E12M020

3.0

G85000E12M030

G85002E12M030

- 1 Brown
- 2 Blue
- 3 Yellow/Green

PUR

0.6

G85000P12M006

G85002P12M006

1.0

G85000P12M010

G85002P12M010

2.0

G85000P12M020

G85002P12M020

3.0

G85000P12M030

G85002P12M030

G85A00E12M006

G85A00E12M010

G85A00E12M020

G85A00E12M030

G85A00P12M006

G85A00P12M010

G85A00P12M020

G85A00P12M030

Form C Ind (9.4mm) 2 pole + earth – 24 V LED & VDR

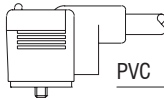
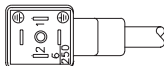

PVC

0.6

G850B0E12M006

G850B2E12M006

1.0

G850B0E12M010

G850B2E12M010

2.0

G850B0E12M020

G850B2E12M020

3.0

G850B0E12M030

G850B2E12M030

- 1 Brown
- 2 Blue
- 3 Yellow/Green

PUR

0.6

G850B0P12M006

G850B2P12M006

1.0

G850B0P12M010

G850B2P12M010

2.0

G850B0P12M020

G850B2P12M020

3.0

G850B0P12M030

G850B2P12M030

Also compatible with Twin I/O Multi-Ports

G85AB0E12M006

G85AB0E12M010

G85AB0E12M020

G85AB0E12M030

G85AB0P12M006

G85AB0P12M010

G85AB0P12M020

G85AB0P12M030

Micro-Change® (M12) Adapters and In-Line Splitters

M12 Single I/O Multi-Port

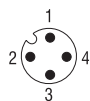

- 1 Brown
- 3 Blue
- 4 Black

Female Connector

M12 Twin I/O Multi-Port

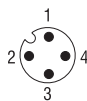

- 1 Brown
- 2 White
- 3 Blue
- 4 Black

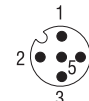

- 1 Brown
- 2 Black B
- 3 Blue
- 4 Black A
- 5 Yellow/Green

Adapter & In-line Splitter M8 to M12



- 1 Brown
- 2 White
- 3 Blue
- 4 Black

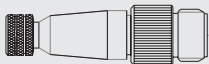

483030

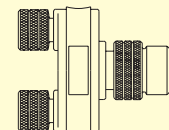

484A30

Adapter M8 to M12



- 1 Brown
- 2 White
- 3 Blue
- 4 Black

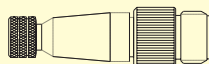

484030

In-line Splitter M12 to M12

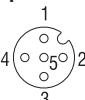

- 1 Brown
- 2 White
- 3 Blue
- 4 Black
- 5 Yellow/Green

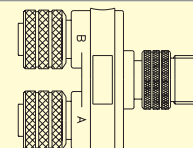

885A30

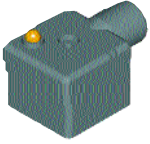

M12 Single I/O Multi-Port

Female Connector

Circuit

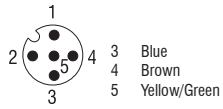

WIRING CONFIGURATION

Form A (18mm) 2 pole + earth

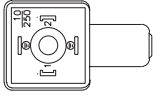

- 1 Brown
- 2 Blue
- 3 Yellow/Green

None
24 V LED & VDR

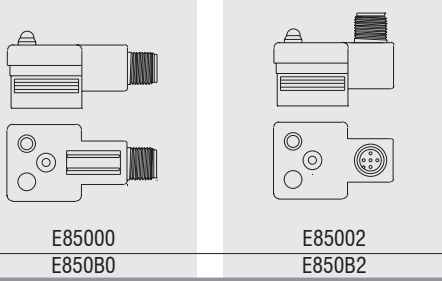

E85000
E850B0

E85002
E850B2

Form B (11mm) 2 pole + 12 o'clock earth

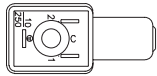

- 1 Brown
- 2 Blue
- 3 Yellow/Green

None
24 V LED & VDR

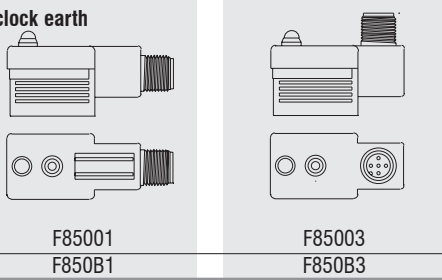

F85001
F850B1

F85003
F850B3

Form B (11mm) 2 pole + 6 o'clock earth

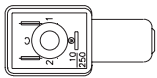

- 1 Brown
- 2 Blue
- 3 Yellow/Green

None
24 V LED & VDR

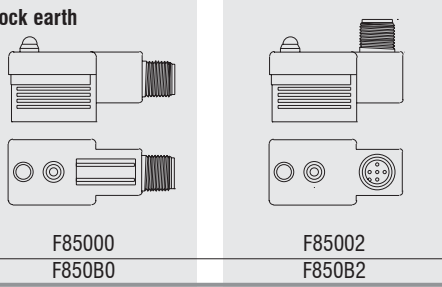

F85000
F850B0

F85002
F850B2

Form B (10mm) 2 pole + 12 o'clock earth

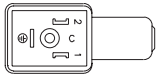

- 1 Brown
- 2 Blue
- 3 Yellow/Green

None
24 V LED & VDR

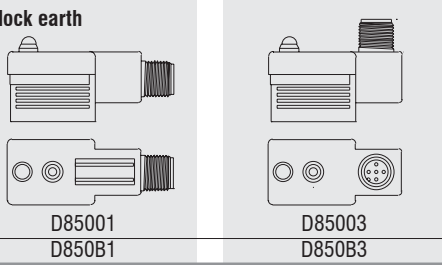

D85001
D850B1

D85003
D850B3

Form B (10mm) 2 pole + 6 o'clock earth

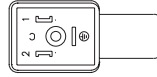

- 1 Brown
- 2 Blue
- 3 Yellow/Green

None
24 V LED & VDR

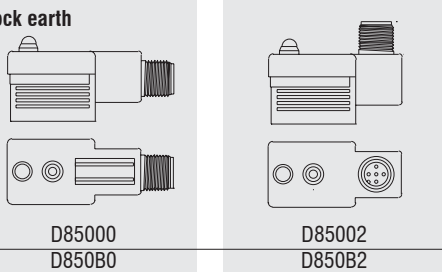

D85000
D850B0

D85002
D850B2

NANO-CHANGE® CONNECTORS

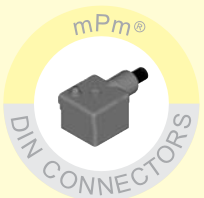
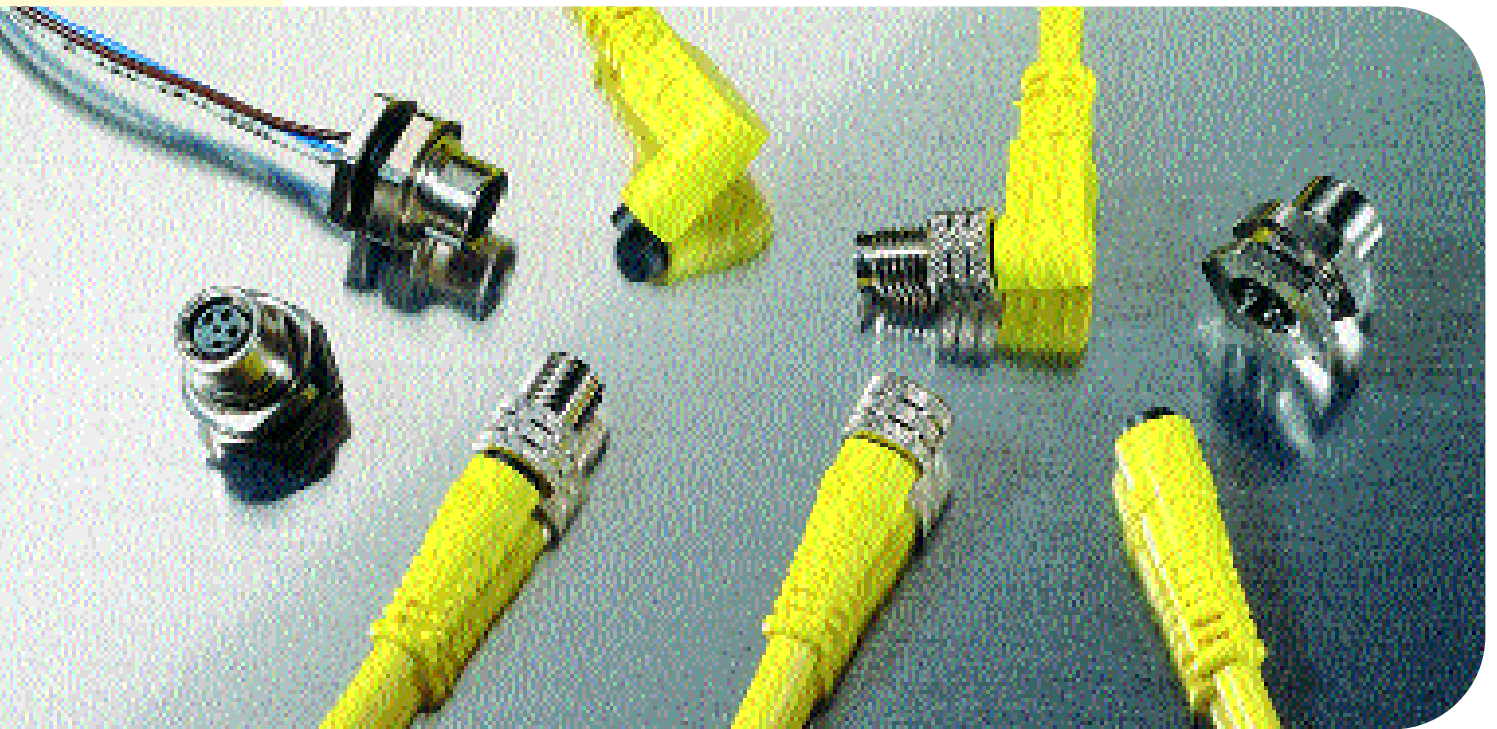

- **Quick disconnect provides simple and fast connection for the easy replacement and installation of control devices such as proximity switches**
- **Lightweight and compact, factory assembled and tested connectors reduce the risk of costly wiring errors**
- **Anti-vibration couplings ensure the connector remains secure in harsh environments, maintaining the IP67 waterproof seal and integrity of the system**



3 Pole

- 1 Brown
- 3 Blue
- 4 Black



4 Pole

- 1 Brown
- 2 White
- 3 Blue
- 4 Black



5 Pole

- 1 Brown
- 2 White
- 3 Blue
- 4 Black
- 5 Grey

WIRING CONFIGURATION

Female Connector

Cable Length (m)

Nano-Change® (M8) Straight

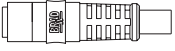

PVC	2.0	503000E03M020	504000E03M020		
	5.0	503000E03M050	504000E03M050		
	10.0	503000E03M100	504000E03M100		
PUR	2.0	503000P03M020	504000P03M020	505000P02M020	
	5.0	503000P03M050	504000P03M050	505000P02M050	
	10.0	503000P03M100	504000P03M100	505000P02M100	

Nano-Change® (M8) 90°

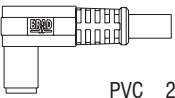

PVC	2.0	503001E03M020	504001E03M020		
	5.0	503001E03M050	504001E03M050		
	10.0	503001E03M100	504001E03M100		
PUR	2.0	503001P03M020	504001P03M020	505001P02M020	
	5.0	503001P03M050	504001P03M050	505001P02M050	
	10.0	503001P03M100	504001P03M100	505001P02M100	

Nano-Change® (M8) 90° PNP LED

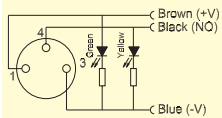
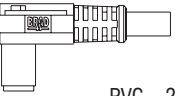

PVC	2.0	5030P1E03M020			
	5.0	5030P1E03M050			
	10.0	5030P1E03M100			
PUR	2.0	5030P1P03M020			
	5.0	5030P1P03M050			
	10.0	5030P1P03M100			



3 Pole

- 1 Brown
- 3 Blue
- 4 Black



4 Pole

- 1 Brown
- 2 White
- 3 Blue
- 4 Black

WIRING CONFIGURATION

Male Connector

(Fixed thread)

Cable Length (m)

Nano-Change® (M8) Straight



PVC	2.0	503006E03M020	504006E03M020		
	5.0	503006E03M050	504006E03M050		
	10.0	503006E03M100	504006E03M100		
PUR	2.0	503006P03M020	504006P03M020		
	5.0	503006P03M050	504006P03M050		
	10.0	503006P03M100	504006P03M100		

Nano-Change® (M8) Coupler Moulded Connectors



3 Pole

- 1 Brown
- 3 Blue
- 4 Black



4 Pole

- 1 Brown
- 2 White
- 3 Blue
- 4 Black



5 Pole

- 1 Brown
- 2 White
- 3 Blue
- 4 Black
- 5 Grey

Female Connector

Cable Length (m)

WIRING CONFIGURATION

Nano-Change® (M8) Straight



PVC	2.0	403000E03M020	404000E03M020		
	5.0	403000E03M050	404000E03M050		
	10.0	403000E03M100	404000E03M100		
PUR	2.0	403000P03M020	404000P03M020	405000P02M020	
	5.0	403000P03M050	404000P03M050	405000P02M050	
	10.0	403000P03M100	404000P03M100	405000P02M100	

Nano-Change® (M8) 90°

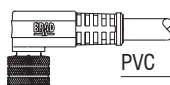

PVC	2.0	403001E03M020	404001E03M020		
	5.0	403001E03M050	404001E03M050		
	10.0	403001E03M100	404001E03M100		
PUR	2.0	403001P03M020	404001P03M020	405001P02M020	
	5.0	403001P03M050	404001P03M050	405001P02M050	
	10.0	403001P03M100	404001P03M100	405001P02M100	

Nano-Change® (M8) 90° PNP LED

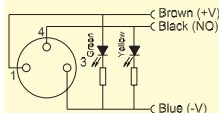
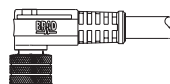

PVC	2.0	4030P1E03M020			
	5.0	4030P1E03M050			
	10.0	4030P1E03M100			
PUR	2.0	4030P1P03M020			
	5.0	4030P1P03M050			
	10.0	4030P1P03M100			



3 Pole

- 1 Brown
- 3 Blue
- 4 Black



4 Pole

- 1 Brown
- 2 White
- 3 Blue
- 4 Black



5 Pole

- 1 Brown
- 2 White
- 3 Blue
- 4 Black
- 5 Grey

Male Connector

Cable Length (m)

WIRING CONFIGURATION

Nano-Change® (M8) Straight

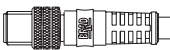

PVC	2.0	403006E03M020	404006E03M020		
	5.0	403006E03M050	404006E03M050		
	10.0	403006E03M100	404006E03M100		
PUR	2.0	403006P03M020	404006P03M020	405006P02M020	
	5.0	403006P03M050	404006P03M050	405006P02M050	
	10.0	403006P03M100	404006P03M100	405006P02M100	

Nano-Change® (M8) 90°

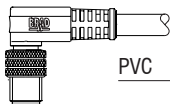

PVC	2.0	403007E03M020	404007E03M020		
	5.0	403007E03M050	404007E03M050		
	10.0	403007E03M100	404007E03M100		
PUR	2.0	403007P03M020	404007P03M020	405007P02M020	
	5.0	403007P03M050	404007P03M050	405007P02M050	
	10.0	403007P03M100	404007P03M100	405007P02M100	



3 Pole
1 Brown
3 Blue
4 Black



4 Pole
1 Brown
2 White
3 Blue
4 Black



3 Pole
1 Brown
3 Blue
4 Black



4 Pole
1 Brown
2 White
3 Blue
4 Black

Female Attachable

Termination

WIRING CONFIGURATION

Nano-Change® (M8) Straight

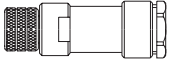

Solder

N03FA03124

N04FA03124

Nano-Change® (M8) 90°

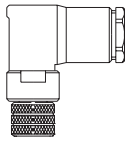

Solder

N03FA04124

N04FA04124

Male Attachable

Termination

WIRING CONFIGURATION

Nano-Change® (M8) Straight

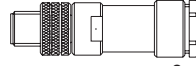

Screw
Solder

N03MA03134
N03MA03124

N04MA03134
N04MA03124

Nano-Change® (M8) 90°

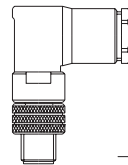

Solder

N03MA04124

N04MA04124

Nano-Change® (M8) Receptacles



3 Pole
1 Brown
3 Blue
4 Black



4 Pole
1 Brown
2 White
3 Blue
4 Black



5 Pole
1 Brown
2 White
3 Blue
4 Black
5 Grey

Wire length (mm)

WIRING CONFIGURATION

Nano-Change® M8 Mounting Thread

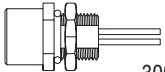

300.0

4R3F30E02C3003

4R4F30E02C3003

4R5F30E02C3003

Nano-Change® PG7 Through Panel

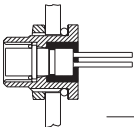

300.0

4R3H40E02C3003

4R4H40E02C3003

4R5H40E02C3003

Nano-Change® PG7 PCB Mount

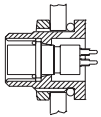

n/a

4R3H400013

4R4H400013

4R5H400013



3 Pole
1 Brown
3 Blue
4 Black



4 Pole
1 Brown
2 White
3 Blue
4 Black



5 Pole
1 Brown
2 White
3 Blue
4 Black
5 Grey

Wire length (mm)

WIRING CONFIGURATION

Nano-Change® M8 Mounting Thread

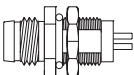

300.0

4R3F06E02C3003

4R4F06E02C3003

4R5F06E02C3003

MICRO-CHANGE® CONNECTORS

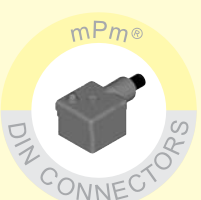

- **Compact and robust design sealed waterproof to IP68, with additional optional benefit of plastic or stainless steel couplings for corrosion resistance in wash down environments**
- **Choice of cable type and length reduces stock variations of I/O devices and provides solutions for food processing, machining and applications demanding shielded or halogen free cables**
- **Weld splatter resistant coupling nuts and cables are available as options for harsh operating conditions**

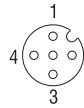

1 Brown
3 Blue
4 Black

5 Pole/3 Wire

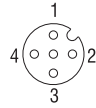

1 Brown 3 Blue
2 White 4 Black

5 Pole/4 Wire

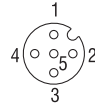

1 Brown 4 Black
2 White 5 Grey
3 Blue

5 Pole/5 Wire

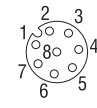

1 White 5 Grey
2 Brown 6 Pink
3 Green 7 Blue
4 Yellow 8 Red

8 Pole

Female Connector

Cable Length (m)

WIRING CONFIGURATION

WIRING CONFIGURATION

Micro-Change® (M12) Straight

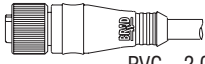

PVC	2.0	803000E03M020	804000E03M020	805000E03M020	
	5.0	803000E03M050	804000E03M050	805000E03M050	
	10.0	803000E03M100	804000E03M100	805000E03M100	
PUR	2.0	803000P03M020	804000P03M020	805000P03M020	808000P02M020
	5.0	803000P03M050	804000P03M050	805000P03M050	808000P02M050
	10.0	803000P03M100	804000P03M100	805000P03M100	808000P02M100
SJTO	2.0	803000S20M020	804000S20M020	805000S26M020	
	5.0	803000S20M050	804000S20M050	805000S26M050	
	10.0	803000S20M100	804000S20M100	805000S26M100	

Micro-Change® (M12) 90°

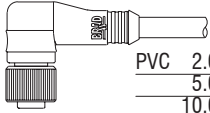

PVC	2.0	803001E03M020	804001E03M020	805001E03M020	
	5.0	803001E03M050	804001E03M050	805001E03M050	
	10.0	803001E03M100	804001E03M100	805001E03M100	
PUR	2.0	803001P03M020	804001P03M020	805001P03M020	808001P02M020
	5.0	803001P03M050	804001P03M050	805001P03M050	808001P02M050
	10.0	803001P03M100	804001P03M100	805001P03M100	808001P02M100
SJTO	2.0	803001S20M020	804001S20M020	805001S26M020	
	5.0	803001S20M050	804001S20M050	805001S26M050	
	10.0	803001S20M100	804001S20M100	805001S26M100	

Micro-Change® (M12) PNP Single I/O LED

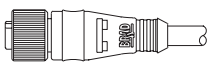

PVC	2.0	8030P0E03M020	8040P0E03M020		
	5.0	8030P0E03M050	8040P0E03M050		
	10.0	8030P0E03M100	8040P0E03M100		
PUR	2.0	8030P0P03M020	8040P0P03M020		
	5.0	8030P0P03M050	8040P0P03M050		
	10.0	8030P0P03M100	8040P0P03M100		
SJTO	2.0	8030P0S20M020	8040P0S20M020		
	5.0	8030P0S20M050	8040P0S20M050		
	10.0	8030P0S20M100	8040P0S20M100		

Micro-Change® (M12) 90° PNP Single I/O LED

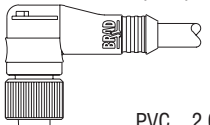

PVC	2.0	8030P1E03M020	8040P1E03M020		
	5.0	8030P1E03M050	8040P1E03M050		
	10.0	8030P1E03M100	8040P1E03M100		
PUR	2.0	8030P1P03M020	8040P1P03M020		
	5.0	8030P1P03M050	8040P1P03M050		
	10.0	8030P1P03M100	8040P1P03M100		
SJTO	2.0	8030P1S20M020	8040P1S20M020		
	5.0	8030P1S20M050	8040P1S20M050		
	10.0	8030P1S20M100	8040P1S20M100		

Micro-Change® (M12) 90° PNP Twin I/O LED

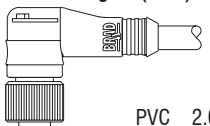

PVC	2.0	8043P1E03M020		
	5.0	8043P1E03M050		
	10.0	8043P1E03M100		
PUR	2.0	8043P1P03M020		
	5.0	8043P1P03M050		
	10.0	8043P1P03M100		
SJTO	2.0	8043P1S20M020		
	5.0	8043P1S20M050		
	10.0	8043P1S20M100		

Micro-Change® (M12) Moulded Connectors

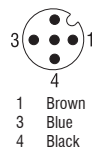

5 Pole/3 Wire

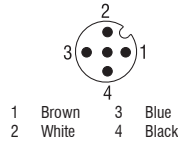

5 Pole/4 Wire

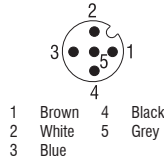

5 Pole/5 Wire

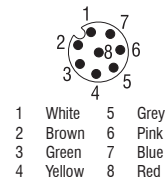

8 Pole

Male Connector

Cable Length (m)

WIRING CONFIGURATION

WIRING CONFIGURATION

Micro-Change® (M12) Straight



PVC	2.0	803006E03M020	804006E03M020	805006E03M020	
	5.0	803006E03M050	804006E03M050	805006E03M050	
	10.0	803006E03M100	804006E03M100	805006E03M100	
PUR	2.0	803006P03M020	804006P03M020	805006P03M020	808006P02M020
	5.0	803006P03M050	804006P03M050	805006P03M050	808006P02M050
	10.0	803006P03M100	804006P03M100	805006P03M100	808006P02M100
SJTO	2.0	803006S20M020	804006S20M020	805006S26M020	
	5.0	803006S20M050	804006S20M050	805006S26M050	
	10.0	803006S20M100	804006S20M100	805006S26M100	

Micro-Change® (M12) 90°

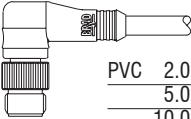

PVC	2.0	803007E03M020	804007E03M020	805007E03M020	
	5.0	803007E03M050	804007E03M050	805007E03M050	
	10.0	803007E03M100	804007E03M100	805007E03M100	
PUR	2.0	803007P03M020	804007P03M020	805007P03M020	808007P02M020
	5.0	803007P03M050	804007P03M050	805007P03M050	808007P02M050
	10.0	803007P03M100	804007P03M100	805007P03M100	808007P02M100
SJTO	2.0	803007S20M020	804007S20M020	805007S26M020	
	5.0	803007S20M050	804007S20M050	805007S26M050	
	10.0	803007S20M100	804007S20M100	805007S26M100	

Micro-Change® (M12) Field Attachable Connectors

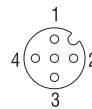

4 Pole

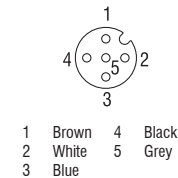

5 Pole

WIRING CONFIGURATION

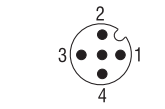

4 Pole

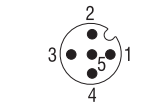

5 Pole

WIRING CONFIGURATION

Female Attachables

Cable diameter

Termination

Micro-Change® (M12) Straight

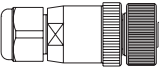

2.5 - 6.5	Screw	8A4000-315	8A5000-315
4.0 - 7.5	Screw	8A4000-325	8A5000-325

Micro-Change® (M12) 90°

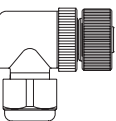

2.5 - 6.5	Screw	8A4001-315	8A5001-315
-----------	-------	------------	------------

Male Attachable

Cable diameter

Termination

Micro-Change® (M12) Straight

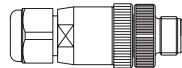

2.5 - 6.5	Screw	8A4006-315	8A5006-315
4.0 - 7.5	Screw	8A4006-325	8A5006-325

Micro-Change® (M12) 90°

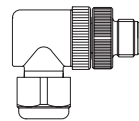

2.5 - 6.5	Screw	8A4007-315	8A5007-315
-----------	-------	------------	------------

IDC - Insulation Displacement Contact. This connector is only available in 4 pole straight versions and is slightly larger than the model illustrated. Note: IDC version is available with plastic coupling nut, add 5 to end of part number to order. Example 8A4000-4255.

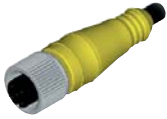

Female Receptacle

Wire length (mm)

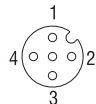

- 1 Brown 3 Blue
- 2 White 4 Black

4 Pole

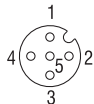

- 1 Brown 4 Black
- 2 White 5 Grey
- 3 Blue

5 Pole



- 1 White 5 Grey
- 2 Brown 6 Pink
- 3 Green 7 Blue
- 4 Yellow 8 Red

8 Pole

WIRING CONFIGURATION

Micro-Change® Female M14 Panel Mount

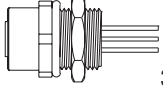

300.0

8R4E30E03C3003

8R5E30E03C3003

8R8E30E03C3003

Micro-Change® Female PG9 Panel Mount

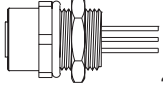

300.0

8R4J30E03C3003

8R5J30E03C3003

8R8J30E03C3003

Micro-Change® Female PG9 PCB Mount

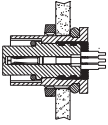

n/a

8R4J400013

8R5J400013

n/a

Micro-Change® Female PG9 Through Panel

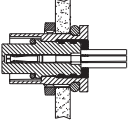

300.0

8R4J40E03C3003

8R5J40E03C3003

n/a

Male Receptacle

Wire Length (mm)

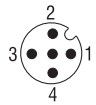

- 1 Brown 3 Blue
- 2 White 4 Black

4 Pole

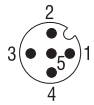

- 1 Brown 4 Black
- 2 White 5 Grey
- 3 Blue

5 Pole

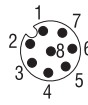

- 1 White 5 Grey
- 2 Brown 6 Pink
- 3 Green 7 Blue
- 4 Yellow 8 Red

8 Pole

WIRING CONFIGURATION

Micro-Change® Male M14 Panel Mount

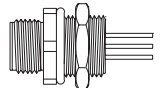

300.0

8R4E36E03C3003

8R5E36E03C3003

8R8E36E03C3003

Micro-Change® Male PG9 Panel Mount

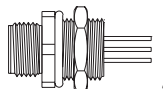

300.0

8R4J36E03C3003

8R5J36E03C3003

8R8J36E03C3003

Micro-Change® Male PG9 PCB Mount

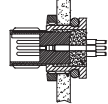

n/a

8R4J460003

8R5J460003*

n/a

Micro-Change® Male PG9 Through Panel

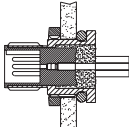

300.0

8R4J46E03C3003

8R5J46E03C3003

n/a

Micro-Change® Male PG13.5 Short Sensor Mount

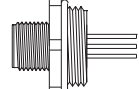

300.0

8R4D26E03C3003

8R5D26E03C3003

n/a

* Check sales office for availability

MPM® DIN 43650 CONNECTORS



- **Integral LED indication and suppression, provide indication of function and elimination of potentially damaging induced spikes**
- **Simple screw termination of field attachable connectors or factory moulded and tested connectors for simple installation of devices**
- **Choice of Form A, B and C connectors to both DIN 43650 and industrial standards are compatible with solenoid valves from all leading manufacturers**

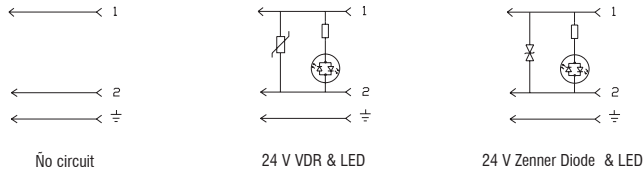
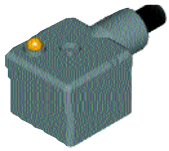

Moulded Connector

Cable Length (m)

WIRING INFORMATION & CIRCUIT

		None	AC/DC 24 V VDR & LED	AC/DC 24 V Zener Diode & LED		
Form A (18mm) 2 pole + earth						
	PVC	2.0	E152N20011	E452N20011C4H	E452N20011SOH	
		5.0	E152N50011	E452N50011C4H	E452N50011SOH	
		10.0	E152N10K11	E452N10K11C4H	E452N10K11SOH	
1	Brown					
2	Blue					
3	Yellow/ Green	PUR/PVC	2.0	E152P20011	E452P20011C4H	E452P20011SOH
			5.0	E152P50011	E452P50011C4H	E452P50011SOH
			10.0	E152P10K11	E452P10K11C4H	E452P10K11SOH
Form B Ind (11mm) 2 pole + 12 o'clock earth						
	PVC	2.0	E162N20021	E462N20021C4H	E462N20021SOH	
		5.0	E162N50021	E462N50021C4H	E462N50021SOH	
		10.0	E162N10K21	E462N10K21C4H	E462N10K21SOH	
1	Brown					
2	Blue					
3	Yellow/ Green	PUR/PVC	2.0	E162P20021	E462P20021C4H	E462P20021SOH
			5.0	E162P50021	E462P50021C4H	E462P50021SOH
			10.0	E162P10K21	E462P10K21C4H	E462P10K21SOH
Form B Ind (11mm) 2 pole + 6 o'clock earth						
	PVC	2.0	E162N20061	E462N20061C4H	E462N20061SOH	
		5.0	E162N50061	E462N50061C4H	E462N50061SOH	
		10.0	E162N10K61	E462N10K61C4H	E462N10K61SOH	
1	Brown					
2	Blue					
3	Yellow/ Green	PUR/PVC	2.0	E162P20061	E462P20061C4H	E462P20061SOH
			5.0	E162P50061	E462P50061C4H	E462P50061SOH
			10.0	E162P10K61	E462P10K61C4H	E462P10K61SOH
Form B DIN (10mm) 2 pole + 12 o'clock earth						
	PVC	2.0	E072N20021	E472N20021C4H	E472N20021SOH	
		5.0	E072N50021	E472N50021C4H	E472N50021SOH	
		10.0	E072N10K21	E472N10K21C4H	E472N10K21SOH	
1	Brown					
2	Blue					
3	Yellow/ Green	PUR/PVC	2.0	E072P20021	E472P20021C4H	E472P20021SOH
			5.0	E072P50021	E472P50021C4H	E472P50021SOH
			10.0	E072P10K21	E472P10K21C4H	E472P10K21SOH

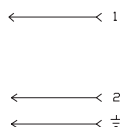
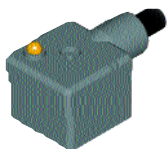

No circuit

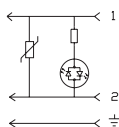

24 V VDR & LED

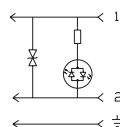

24 V Zenner Diode & LED

Moulded Connector

Cable

Length (m)

WIRING INFORMATION & CIRCUIT

		None	AC/DC 24 V VDR & LED	AC/DC 24 V Zenner Diode & LED		
Form B DIN (10mm) 2 pole + 6 o'clock earth						
	PVC	2.0	E072N20061	E472N20061C4H	E472N20061SOH	
1	Brown	5.0	E072N50061	E472N50061C4H	E472N50061SOH	
3	Blue	10.0	E072N10K61	E472N10K61C4H	E472N10K61SOH	
4	Black					
	PUR/PVC	2.0	E072P20061	E472P20061C4H	E472P20061SOH	
		5.0	E072P50061	E472P50061C4H	E472P50061SOH	
		10.0	E072P10K61	E472P10K61C4H	E472P10K61SOH	
Form C DIN (8.0mm) 2 pole + earth						
	PVC	2.0	E432N20011	E492N20011C4H	E492N20011SOH	
1	Brown	5.0	E432N50011	E492N50011C4H	E492N50011SOH	
3	Blue	10.0	E432N10K11	E492N10K11C4H	E492N10K11SOH	
4	Black					
	PUR/PVC	2.0	E432P20011	E492P20011C4H	E492P20011SOH	
		5.0	E432P50011	E492P50011C4H	E492P50011SOH	
		10.0	E432P10K11	E492P10K11C4H	E492P10K11SOH	
Form C Ind (9.4mm) 2 pole + earth						
	PVC	2.0	E332N20011	E392N20011C4H	E392N20011SOH	
1	Brown	5.0	E332N50011	E392N50011C4H	E392N50011SOH	
3	Blue	10.0	E332N10K11	E392N10K11C4H	E392N10K11SOH	
4	Black					
	PUR/PVC	2.0	E332P20011	E392P20011C4H	E392P20011SOH	
		5.0	E332P50011	E392P50011C4H	E392P50011SOH	
		10.0	E332P10K11	E392P10K11C4H	E392P10K11SOH	



Attachable Connector

Gland Size

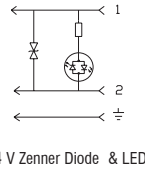
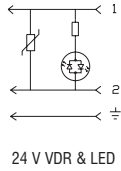
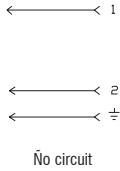

WIRING INFORMATION & CIRCUIT

	None	AC/DC 24 V VDR & LED	AC/DC 24 V Zenner Diode & LED		
Form A (18mm) 2 pole + earth					
PG9	C18209N21	S18209TC421	S18209TS021		
PG11	C18211N21	S18211TC421	S18211TS021		
Form B Ind (11mm) 2 pole + earth					
PG7	C12207N21	S02207TC421	S02207TS021		
PG9	C12209N21	S02209TC421	S02209TS021		
Form B DIN (10mm) 2 pole + earth					
PG7	C62207N21	S62207TC421	S62207TS021		
PG9	C62209N21	S62209TC421	S62209TS021		
Form C DIN (8.0mm) 2 pole + earth					
PG7	C05207N62	S05207TC422	n/a		
Form C Ind (9.4mm) 2 pole + earth					
PG7	C19207N62	S19207TC422	n/a		

Options: Alternative types of suppression see page 40 for more information

OPTIONS

Multi-Port Splitter Box Matrix

B T Y 8 0 0 P - F B P - 0 5

Nano-Change® Multi-Ports
 BEY - End Cable Entry
 BNY - Top Cable Entry & Connector
Micro-Change® Multi-Ports
 BTY - Top Mount
 BSY - Side Mount

Length
 05 - 5 metres
 10 - 10 metres
 20 - 20 metres

* Refer to cable specification and use code indicated in matrix above

**NPN or no LED indication, select from above part number matrixes, minimum order quantity 25 pieces for Connectors and 5 pieces for Multi-Ports

Number of Ports
 4 - 4 Ports 8 - 8 Ports
 6 - 6 Ports A - 10 Ports

Wiring Configuration
 00/01 - 5 Pole/4 Wire - Single I/O per port
 03/05 - 5 Pole/5 Wire - Twin I/O per port
 04 - 4 Pole/3 Wire - Single I/O per port - no earth

LED Configuration
 P - PNP Format N - NPN Format** 0 - No LEDs**

Termination Options

Pre-wired versions*

E - PVC Cable
 P - PUR Cable
 M - PUR/PVC Cable

Connectorised versions

B - Mini-Change® Connector
 C - M16 or M23 Connector

Receptacle Material

FB - Standard
 FX - Plastic**
 FS - Stainless Steel**

Connecto rMatrix

8 0 3 0 0 0 E 0 3 M 0 2 0

Options:

Not all are available on standard delivery terms, please consult our sales office before ordering

* Refer to cable specification and use code indicated in matrix above

**NPN or no LED indication, select from above part number matrixes, minimum order quantity 25 pieces for Connectors and 5 pieces for Multi-Ports

**Coupling materials and connector colour minimum quantities apply to all orders

**Choice of suppression and LED colour for mPm® product, please request separate catalogue

Connector Type

Nano-Change® M8 Snap
 50 - Moulded Connector
 55 - Nano Jumper
 58 - Nano to Micro Jumper

Nano-Change® M8 Coupler
 40 - Moulded Connector
 44 - Nano Jumper
 48 - Nano to Micro Jumper

Micro-Change® M12 Coupler
 80 - Moulded Connector
 88 - Micro Jumper
 84 - Micro to Nano Jumper

mPm® DIN 43650 Jumpers
 D4 - Form B (10mm) to Nano
 E4 - Form A (18mm) to Nano
 F4 - Form B (11mm) to Nano
 G4 - Form C (9.4mm) to Nano
 H4 - Form C (8.0mm) to Nano
 D8 - Form B (10mm) to Micro
 E8 - Form A (18mm) to Micro
 F8 - Form B (11mm) to Micro
 G8 - Form C (9.8mm) to Micro
 H8 - Form C (8.0mm) to Micro

Cable ID No.*

E03 - Yellow PVC 0.34mm²
 P03 - Black PUR 0.34mm²
 S20 - Yellow SJTO type 0.34mm²

Cable Length

M010 - 1.0 metres
 M020 - 2.0 metres
 M030 - 3.0 metres

Coupling Materials**

1 - Stainless Steel 5 - Plastic 7 - Teflon coated

Connector Colour**

A - Grey Head Moulding G - Black Head Moulding

Head Configuration

Moulded Connectors

000 - Female Straight
 001 - Female 90°
 0N0 - Female Straight NPN LED**
 0N1 - Female 90° NPN LED**
 0P0 - Female Straight PNP LED
 0P1 - Female 90° PNP LED
 006 - Male Straight
 007 - Male 90°

Jumpers - Basic Brad® Only

030 - Female Straight to Male Straight
 031 - Female 90° to Male Straight
 032 - Female Straight to Male 90°
 033 - Female 90° to Male 90°
 0P6 - Female Straight PNP LED to Male Straight
 0P7 - Female 90° PNP LED to Male Straight
 0P8 - Female Straight PNP LED to Male 90°
 0P9 - Female 90° PNP LED to Male 90°

Number of Poles

3 - 3 Pole 5 - 5 Pole
 4 - 4 Pole 8 - 8 Pole

CONNECTOR SPECIFICATION

Series	40, 4R, 44, 50, 5R, 55	N03, N04	80, 8R, 88	8A	30	mPm® DIN 43650	L0	K0
Product	Nano-Change®	Nano-Change®	Micro-Change®	Micro-Change®	Mini-Change®	mPm® DIN 43650	M16 Connector	M23 Connector
Connector Type	Moulded & Receptacles	Attachables	Moulded & Receptacles	Attachables	Moulded	Moulded & Attachable	Moulded	Moulded
Connector Size	M8 Coupler & Snap	M8 Coupler	M12 Coupler	M12 Coupler	1 1/8" UNF Coupler	Form A, B & C	M16 Coupler	M23 Coupler
Number of Poles	3 to 5	3 & 4	3, 4, 5 & 8	4 & 5	12 & 19	2 + earth	14	12 & 19
Contact Material Female	Gold plated Brass	Gold plated Brass	Gold plated Brass	Silver plated Brass	Gold plated Brass	Silver plated Brass	Gold plated Brass	Gold plated Brass
Male	Gold plated Brass	Gold plated Brass	Gold plated Brass	Silver plated Brass	Gold plated Brass	n/a	n/a	Gold plated Brass
Insert Material	PUR	PA	PUR	PA	PVC	PA (+G)	PPO	PUR
O-ring Material	Viton	Viton	Viton	Viton	n/a	Profiled NBR	EPDM - Rubber	NBR
Body Material	PUR	PA	PUR	PA	PVC	PP	PUR	PUR
Coupling Material	Nickel plated Brass	Nickel plated Brass	Nickel plated Brass	Nickel plated Brass	Epoxy Coated Zinc	n/a	Aluminium	Nickel plated Brass
Voltage Rating Standard	60 Vac/75 Vdc	60 Vac/75 Vdc	3, 4 & 5 pole - 250 Vac/300 Vdc 8 pole - 30 Vac/36 Vdc	4 pole - 250 Vac/300 Vdc 5 pole - 30 Vac/36 Vdc	600 Vac/dc	250 Vac/dc	150 Vac/dc	63 Vac/dc
With LED	10 to 30 Vdc	n/a	10 to 30 Vdc	n/a	n/a	24 Vac/dc	n/a	n/a
Contact Current Rating	4 Amps	4 Amps	4 Amps	4 Amps	Ø 1.0mm - 4 Amps Ø 2.0mm - 13 Amps	Form A & B - 18 Amps Form C - 10 Amps	3 Amps	Ø 1.0mm - 6 Amps Ø 1.5mm - 12 Amps
Protection Class	IP67	IP67	IP68	IP68	IP68	IP65	IP67	IP67

Environmental Rating - IP68. To avoid confusion, we at Woodhead Connectivity have defined IP68 as immersion in water at a pressure of 100 pounds per square inch for a duration of one hour, and wash down at a pressure of 1000 pounds per square inch. When used with a mating pair of Brad Harrison® connectors.

MULTI-PORT SPECIFICATION

Series	BEY & BNY	BEY & BNY	BTY	BTY	BSY	BSY
Product	Nano-Change - Single I/O	Nano-Change - Twin I/O	Micro-Change Top Mount Single I/O	Micro-Change Top Mount Twin I/O	Micro-Change Side Mount Single I/O	Micro-Change Side Mount Twin I/O
I/O Connectors	M8 Coupler	M8 Coupler	M12 Coupler	M12 Coupler	M12 Coupler	M12 Coupler
Number of I/O	4, 6, 8 & 10	8, 12, 16 & 20	4, 6 & 8	8, 12 & 16	4, 6 & 8	8, 12 & 16
Contact Material	Gold plated Brass	Gold plated Brass	Gold plated Brass	Gold plated Brass	Gold plated Brass	Gold plated Brass
Insert Material	PUR	PUR	PBT	PBT	PA	PA
O-ring Material	Viton	Viton	Viton	Viton	Viton	Viton
Body Material	PBT	PBT	PBT	PBT	PA	PA
Coupling Material	Nickel plated Brass	Nickel plated Brass	Nickel plated Brass	Nickel plated Brass	Epoxy coated Zinc	Epoxy coated Zinc
Voltage Rating with LED	10 to 30 Vdc	10 to 30 Vdc	10 to 30 Vdc	10 to 30 Vdc	10 to 30 Vdc	10 to 30 Vdc
Current Rating Per I/O	2 Amps	1 Amps	2 Amps	2 Amps	2 Amps	2 Amps
Total Unit - Cable Version	6 Amps	6 Amps	12 Amps	12 Amps	12 Amps	12 Amps
Total Unit - Connector Version	6 Amps (M12 4 Amps)	3 Amps	12 Amps	12 Amps	12 Amps	12 Amps
Protection Class	Cable - IP68 M16 Connector - IP67 M12 Connector - IP68	Cable - IP68 M16 Connector - IP67	Cable - IP68 M23 Connector - IP67 Mini-Change - IP68	Cable - IP68 M23 Connector - IP67 Mini-Change - IP68 Attachable - IP67	Cable - IP68 Mini-Change - IP68	Cable - IP68 Mini-Change - IP68

CABLE SPECIFICATION

ID No	No of Cores	Jacket Colour	Cross Section	Stranding Group	Screen	Nominal Diameter	Nano-Change	Micro-Change	Mini-Change	M23 Connctr.	M16 Connctr.	mPm DIN 43650	Nano Multi Ports	Micro Multi Ports
PVC - General Purpose - Conveyors, Food Processing, etc - 300 V, -5°C to +70°C, PVC Outer Jacket over PVC Insulation														
E02	3 & 4	Yellow	0.25mm ²	B	None	4.5mm	✓	✓						
E03	3 & 4	Yellow	0.34mm ²	C	None	5.0mm	✓	✓						
	5					5.5mm		✓						
E12	3	Black	0.50mm ²	E	None	5.5mm	✓	✓				✓		
E18	3 & 4	Yellow	0.20mm ²	C	80% Braid	5.0mm	✓	✓						
E51	4	Grey	0.25mm ²	B	None	4.5mm	✓	✓						
E52	3 & 4	Grey	0.34mm ²	C	None	5.0mm	✓	✓						
	5					5.5mm		✓						
PVC for Multi-Ports - General Purpose - Conveyors, Food Processing, etc - 300 V, -5°C to +70°C, PVC Outer Jacket over PVC Insulation														
E80	7	Yellow	4x0.34 & 3x0.75mm ²	C & E	None	8.4mm			✓	✓				✓
	9		6x0.34 & 3x0.75mm ²			9.5mm			✓	✓				✓
	11		8x0.34 & 3x0.75mm ²			9.5mm			✓	✓				✓
	15		12x0.34 & 3x0.75mm ²			9.8mm			✓	✓				✓
	19		16x0.34 & 3x0.75mm ²			11.4mm			✓	✓				✓
CEI PVC - IEC332.3A - Self Extinguishing, Flame Retardant Oil Resistant PVC - 300 V, -5°C to +70°C, CEI PVC Outer Jacket over CEI PVC Insulation														
I02	3 & 4	Grey	0.25mm ²	B	None	4.5mm	✓	✓						
I03	3 & 4	Grey	0.34mm ²	C	None	5.0mm	✓	✓						
	5					5.5mm		✓						
I20	3	Grey	0.34mm ²	C	80% Braid	5.0mm	✓	✓						
	4					6.3mm		✓						
SJTO Type - UL listed/CSA Approved - Self Extinguishing & Flame Retardant - Good weld splatter resistance & rough duty use - 300 V, -40°C to +105°C, UL/CSA PVC Outer Jacket over UL/CSA PVC Insulation														
S20	3 & 4	Yellow	0.34mm ²	D	50% Braid	6.3mm		✓				✓		
S26	5	Yellow	0.34mm ²	D	50% Braid	6.5mm		✓				✓		
PUR - General Purpose, Oil resistant for machining applications - 300 V, -5°C to +90°C, PUR Outer Jacket over PVC Insulation														
P03	3 & 4	Black	0.34mm ²	C	None	5.0mm	✓	✓						
	5					5.5mm		✓						
P08	3 & 4	Yellow	0.25mm ²	A	None	4.5mm	✓	✓						
P09	3 & 4	Black	0.34mm ²	A	None	5.0mm		✓						
P12	3	Black	0.50mm ²	E	None	5.5mm	✓	✓				✓		
P18	4 & 5	Black	0.20mm ²	C	80% Braid	5.0mm	✓	✓						
PUR for Multi-Ports - General Purpose, Oil resistant for machining applications - 300 V, -5°C to +90°C, PUR Outer Jacket over PVC Insulation														
P80	7	Black	4x0.34 & 3x0.75mm ²	C & E	None	8.4mm			✓	✓				✓
	9		6x0.34 & 3x0.75mm ²			9.5mm			✓	✓				✓
	11		8x0.34 & 3x0.75mm ²			9.5mm			✓	✓				✓
	15		12x0.34 & 3x0.75mm ²			9.8mm			✓	✓				✓
	19		16x0.34 & 3x0.75mm ²			11.4mm			✓	✓				✓
P78	6	Black	4x0.34 & 2x0.75mm ²	C & C	None	8.4mm	✓	✓	✓	✓			✓	✓
	8		6x0.34 & 2x0.75mm ²			9.5mm	✓	✓	✓	✓			✓	✓
	10		8x0.34 & 2x0.75mm ²			9.8mm	✓	✓	✓	✓			✓	✓
	12		10x0.34 & 2x0.75mm ²			9.8mm	✓	✓	✓	✓			✓	✓
	14		12x0.34 & 2x0.75mm ²			9.8mm	✓	✓	✓	✓			✓	✓
	18		16x0.34 & 2x0.75mm ²			11.4mm	✓	✓	✓	✓			✓	✓
P75	22		20x0.25 & 2x0.50mm ²	C & C		11.4mm			✓	✓	✓		✓	✓
LSOH PUR - Low Smoke Zero Halogen - Baggage handling, public building use - 300 V, -40°C to +70°C, LSOH PUR Outer Jacket over Polyethylene Insulation														
H03	4	Yellow	0.34mm ²	C	None	5.0mm	✓	✓						
H69	4	Grey	0.20mm ²	C	Foil with Drain	4.5mm	✓	✓						
P20	3	Black	0.34mm ²	C	80% Braid	5.0mm		✓						
	4					5.5mm		✓						
	5					5.8mm		✓						
Irradiated PUR - Machine tool and welding applications - 300 V, -5°C to +105°C, Irradiated PUR Outer Jacket over PVC Insulation														
P82	3 & 4	Orange	0.34mm ²	E	None	5.0mm		✓						

Stranding and Cross Sectional Area Table

Stranding Group	Number of Strands				Diameter 0.75mm ²	of Strands
	0.20mm ²	0.25mm ²	0.34mm ²	0.50mm ²		
A		128	174			0.05mm
B		65				0.07mm
C	27	32	42	64	95	0.10mm
D			26			0.13mm
E			19	28	42	0.15mm

DIMENSIONAL INFORMATION

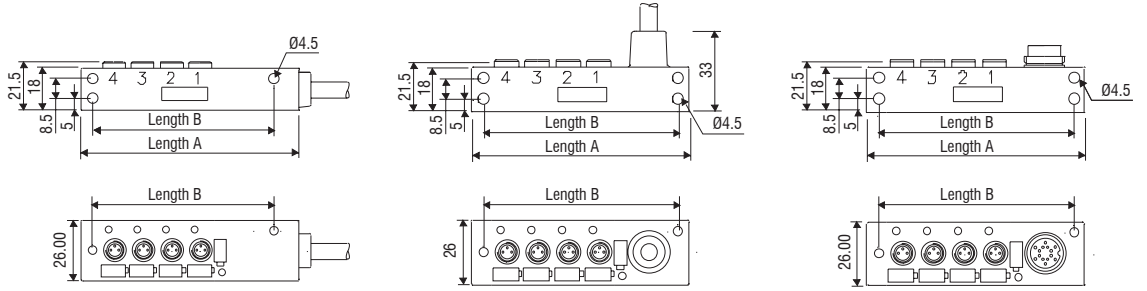

Nano-Change® Cable End Multi-Port

No. of Ports	Length A (mm)	Length B (mm)
4	95	79
6	120	104
8	145	129
10	170	154

Nano-Change® Cable Top Multi-Port

No. of Ports	Length A (mm)	Length B (mm)
4	88	79
6	113	104
8	138	129
10	163	154

Nano-Change® M12 & M16 Con Multi-Port

No. of Ports	Length A (mm)	Length B (mm)
4	88	79
6	113	104
8	138	129
10	163	154

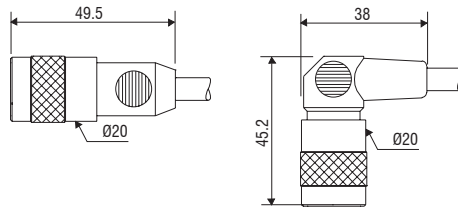

M16 Home Run Connectors for Nano-Change® Multi-Port

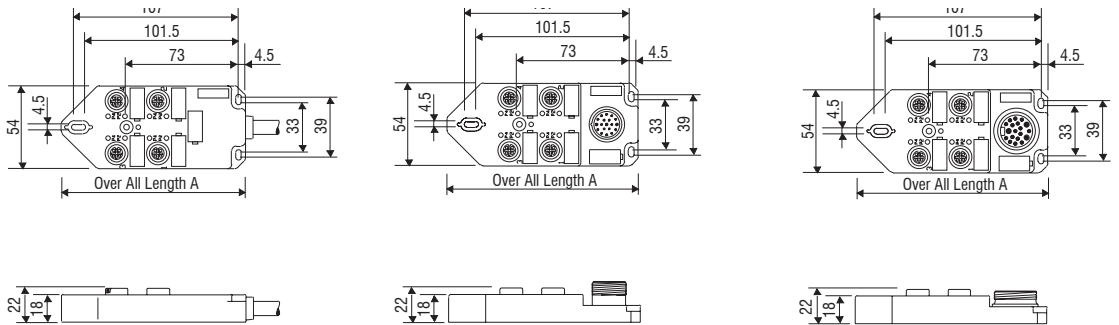

Micro-Change® Top Mount Cable End

No. of Ports	Length A (mm)
4	120
6	125
8	152

Micro-Change® Top Mount M23 Con

No. of Ports	Length A (mm)
4	120
6	125
8	152

Micro-Change® Top Mount Mini-Change

No. of Ports	Length A (mm)
4	120
6	125
8	152

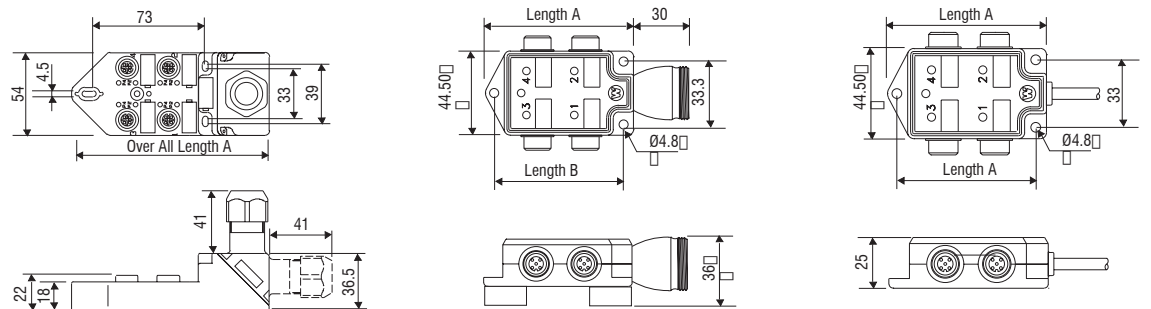

Micro-Change® Field Attachable

No. of Ports	Length A (mm)
4	128.8
6	133.8
8	160.8

Micro-Change® Mini-Con Multi-Port

No. of Ports	Length A (mm)	Length B (mm)
4	78	68
6	104	94
8	129	119

Micro-Change® Cable End Multi-Port

No. of Ports	Length A (mm)	Length B (mm)
4	78	68
6	104	94
8	129	119

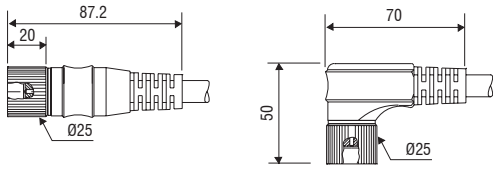

M23 Home Run Connectors for Micro-Change® Multi-Port

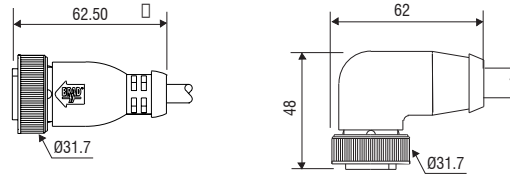

Mini-Change® Home Run Connectors for Micro-Change® Multi-Port

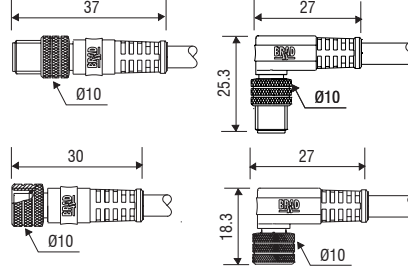
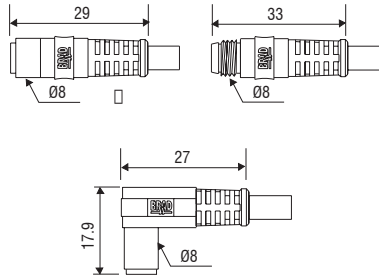

Nano-Change (M8) Snap Moulded Connectors

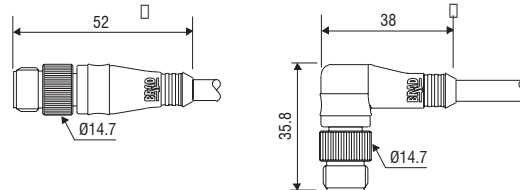
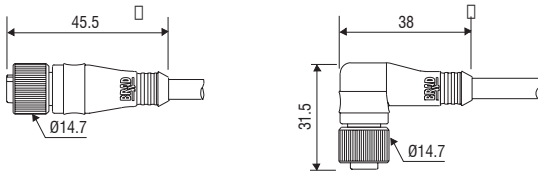

Micro-Change® (M12) Moulded Connectors - Female

Micro-Change® (M12) Moulded Connectors - Male

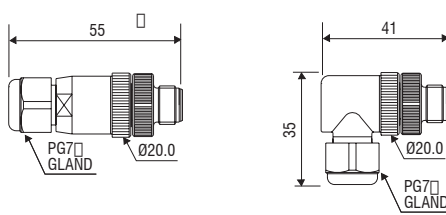
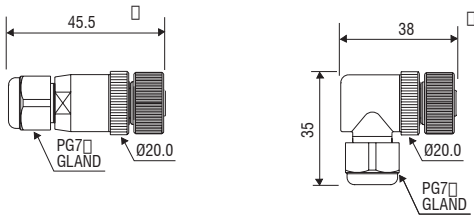

Micro-Change® (M12) Field Attachable Connectors - Female

Micro-Change® (M12) Field Attachable Connectors - Male

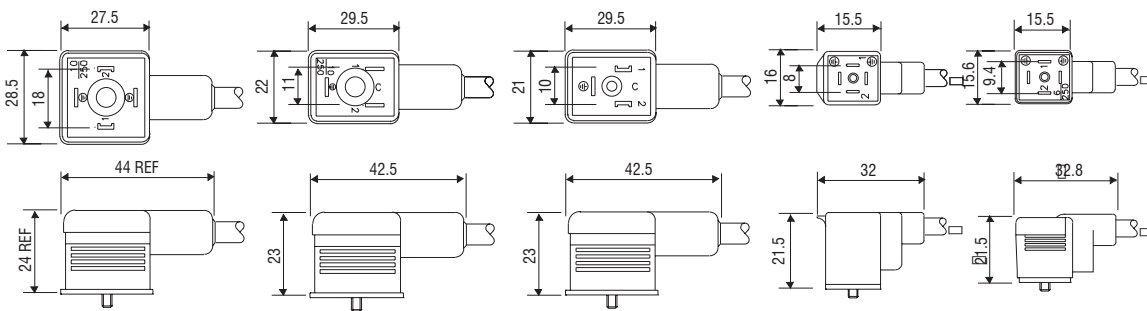

mPm® DIN 43650 Moulded Connectors

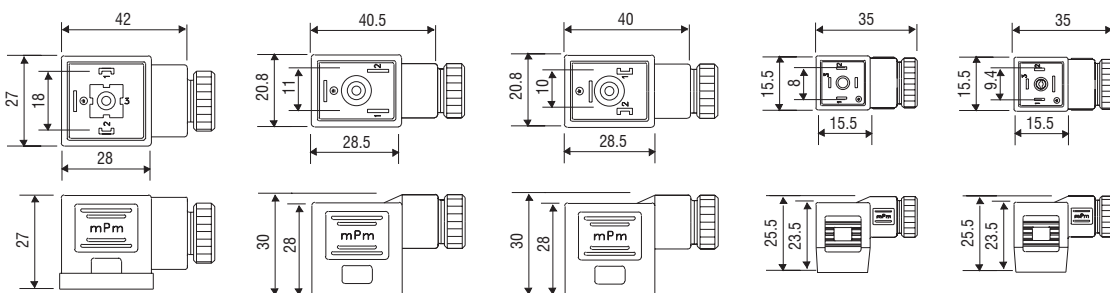

mPm® DIN 43650 Attachable Connectors

United Kingdom

Woodhead Connectivity Ltd.
Factory No. 9
Rassau Industrial Estate
Ebbw Vale, Gwent
Wales
NP23 5SD
Tel. Sales 01495-356300
Fax 01495-356301
General 01495-356310
Email: contact@wdhd.co.uk

France

Woodhead Connectivity S.A.
57, Rue Jacquard BP523
77465 Lagny Cedex
Tel. 01 64 30 91 36
Fax. 01 64 30 91 05
Email: elitec@woodheadfr.com

Applicom International S.A.
43 rue Mazagran
76320 Caudebec-lès-Elbeuf
Tel: 02 32 96 04 20
Fax: 02 32 96 04 21
Email: info@applicom-int.com

Germany

Woodhead Connectivity GmbH
Gewerbstraße 60
75015 Bretten-Gölshausen
Tel. 07252-9496-0
Fax. 07252-9496-99
Email: info@woodhead.de

Applicom International GmbH
Im Gässle 9
70771 Leinfelden-Echterdingen
Tel: 07117-82374-0
Fax: 07117-82374-11
Email: infode@applicom-int.com

Italy

mPm S.r.l.
Via Zucchi
39 int. G
20095 Cusano Milanino (MI)
Tel. 02-66400321
Fax. 02-66400334
Email: info@mpm.woodhead.it

I.M.A. S.r.l.
Piazza della Vittoria,
10 int.6
16121 Genova
Tel: 010-593077
Fax: 010-5956925
E-mail: infoit@applicom-int.com

USA

Woodhead Connectivity N.A.
3411 Woodhead Drive
Northbrook IL 60062
Tel. 847-272-7990
Fax. 847-272-8133

Woodhead Connectivity N.A.
130 Constitution Boulevard
Franklin MA 02038
Tel. 508-541-3400
Fax. 508-541-3419

Woodhead Connectivity N.A.
11501 James Watt Drive
El Paso TX 79936
Tel. 915-591-5600
Fax. 915-598-1718

Applicom International, Inc
4340 Redwood Hwy
Suite D-309
San Rafael CA 94903
Tel: 415-472-1595
Fax: 415-472-1596
Email: infousa@applicom-int.com

Canada

SST
50 Northland Road
Waterloo,
Ontario N2V 1N3
Tel. 519-725-5136
Fax. 519-725-1515

Woodhead Canada Limited
1090 Brevik Place
Mississauga
Ontario L4W 3Y5
Tel. 905-624-6518
Fax. 905-624-9151

Mexico

Woodhead de Mexico S.A. de C.V.
Parque Industrial
Internacional Mexicano
Calle Intermex No. 1351
Cd. Juarez, Chih. 32340
Tel. 52-1624-2504
Fax. 52-1624-4029

Singapore

Woodhead Asia Pte. Ltd.
8 Chia Ping Road,
#05-09/10
JTC Flatted Factory
Jorong Town, 619973
Tel. 261-6533
Fax. 265-6605

Japan

Woodhead Japan Corporation
Unit 4309
Yokohama Landmark Tower
2-2-1 Minato Mirai
Nishi-ku,
Yokohama-shi
Kanagawa-Ken 220-8143
Tel. 04-5224-3560
Fax. 04-5224-3561

W Woodhead Connectivity

SST™ • Brad Harrison® • mPm™ • RJ-Lnxx™ • Applicom™

The Global Leader in Industrial Communications and

www.woodheadconnectivity.com

Nano-Change® Micro-Change®, Mini-Change®, MPIS®, Brad®, Brad Harrison® and mPm® are all registered trademarks of Woodhead Industries, Inc. Every effort has been made to ensure that the information contained within the catalogue is correct and as accurate as possible, no warranty as to this accuracy of this information is implied in any way. With our policy of continuous development, we reserve the right to change any detail within the catalogue without further notice.

All details contained within the catalogue are the sole copyright of Woodhead Connectivity Ltd, a Woodhead Industries, Inc. subsidiary and may not be copied or reproduced in any way without prior written consent. All other trade names and designs acknowledged.

X-ON Electronics

Largest Supplier of Electrical and Electronic Components

Click to view similar products for [Specialized Cables](#) category:

Click to view products by [Molex](#) manufacturer:

Other Similar products are found below :

[585P5S5S](#) [603PT6](#) [603SS6L](#) [604PT6](#) [604SS6](#) [654PT2](#) [654ST2](#) [M83513/04-H02C](#) [M83513/04-H13C](#) [FFA.3S.787.CN](#) [84914-0235](#) [84914-0237](#) [9-1589475-0](#) [1200650264](#) [1200650355](#) [1200650362](#) [1200650392](#) [1200650442](#) [1200650843](#) [1200650880](#) [1200650968](#) [1200651246](#)
[1200651756](#) [1200680096](#) [1200690050](#) [1200690242](#) [1200700133](#) [1200700176](#) [1200700178](#) [1200700218](#) [120070-0224](#) [1200700267](#)
[1200730058](#) [1200730360](#) [120115-0033](#) [1201150044](#) [1200650368](#) [1200650505](#) [1200651330](#) [1200651454](#) [1200651516](#) [1200651571](#)
[1200651580](#) [1200651601](#) [1200652122](#) [1200680196](#) [1200690085](#) [1200690095](#) [1200690153](#) [1200700088](#)