

## DESCRIPTION

The EV020-5-S-00D Evaluation Board is designed to demonstrate the capabilities of MP020-5. The MP020-5 is a primary-side-control regulator which can eliminate secondary feedback components.

The EV020-5-S-00D is typically designed for small appliances which output 18V/0.3A and 5V/0.1A load from 85VAC to 265VAC, 50HZ/60HZ.

The EV020-5-S-00D has an excellent efficiency and meets IEC61000-4-5 surge immunity and EN55022 conducted EMI requirements. It has multi-protection function as open circuit protection, short-circuit protection, cycle by cycle current limit and over-temperature protection, etc.

## ELECTRICAL SPECIFICATION

Parameter	Symbol	Value	Units
Input Voltage	$V_{IN}$	85 to 265	VAC
Output Voltage 1	$V_{OUT1}$	18	V
Output Current 1	$I_{OUT1}$	0.3	A
Output Voltage 2	$V_{OUT2}$	5	V
Output Current 2	$I_{OUT2}$	0.1	A
Output Power	$P_{OUT}$	5.9	W
Efficiency (full load)	$\eta$	>75	%

## FEATURES

- Primary-Side-Control without Opto-Coupler or Secondary Feedback Circuit
- Precise Constant Voltage Control (CV)
- Integrated 700V MOSFET with Minimal External Components
- Variable, Off-Time, Peak-Current Control
- 550 $\mu$ A High-Voltage Current Source
- Programmable Cable Compensation (By adding 1 $\mu$ F/25V ceramic cap at CP pin)
- Multiple Protections: OVP, OCP, OCKP, OTP, and VCC UVLO
- Natural Spectrum Shaping for Improved EMI Signature
- Low Cost and Simple External circuit

## APPLICATIONS

- Small Appliances

All MPS parts are lead-free and adhere to the RoHS directive. For MPS green status, please visit MPS website under Quality Assurance. "MPS" and "The Future of Analog IC Technology", are Registered Trademarks of Monolithic Power Systems, Inc.



High Voltage

**Warning:** Although this board is designed to satisfy safety requirements, the engineering prototype has not been agency approved. Therefore, all testing should be performed using an isolation transformer to provide the AC input to the prototype board.

**EV020-5-S-00D EVALUATION BOARD**



**TOP VIEW**



**BOTTOM VIEW**

(L x W x H) 47mm x 30mm x 17mm

Board Number	MPS IC Number
EV020-5-S-00D	MP020-5GS

### EVALUATION BOARD SCHEMATIC

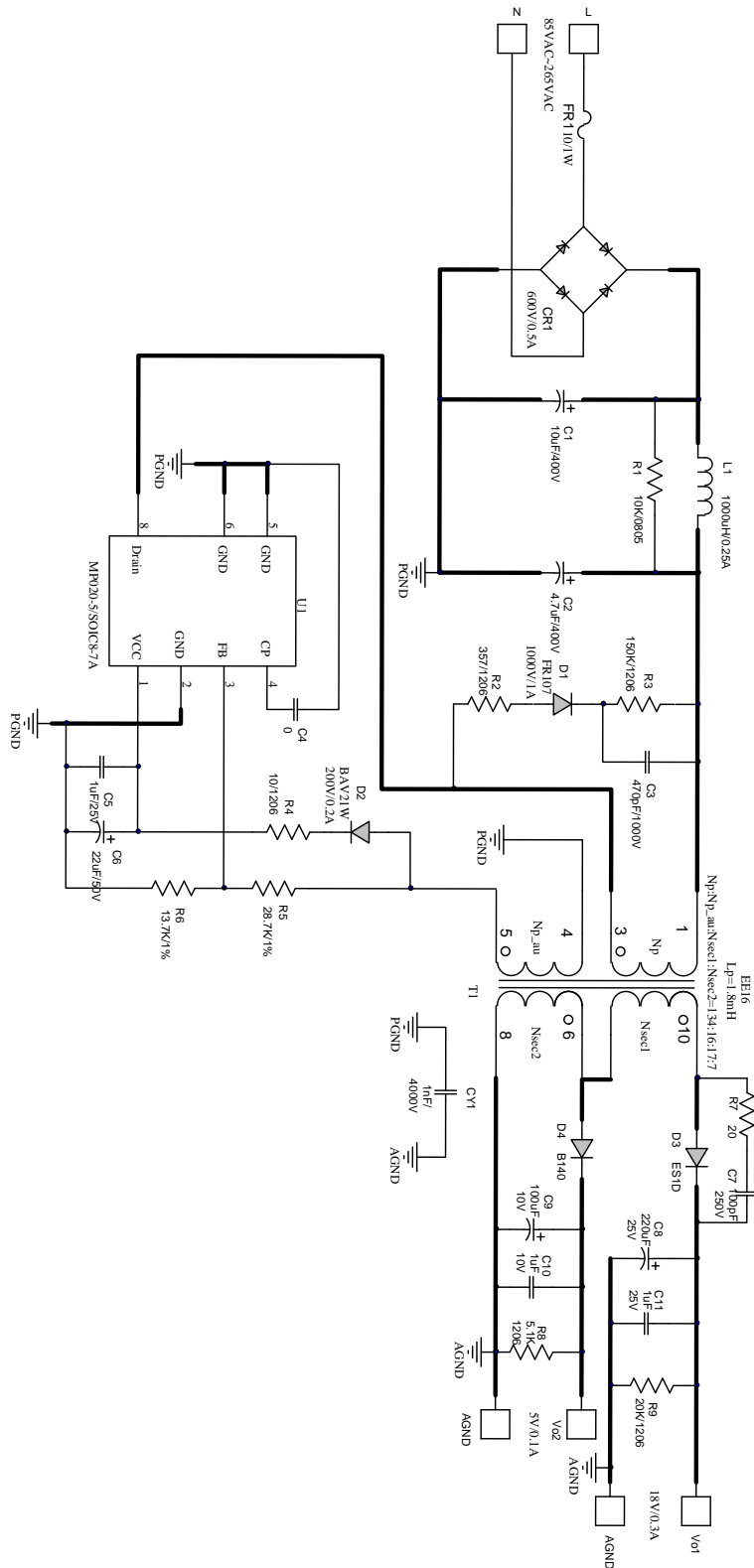

Figure 1—Schematic

PCB LAYOUT (SINGLE-SIDED)

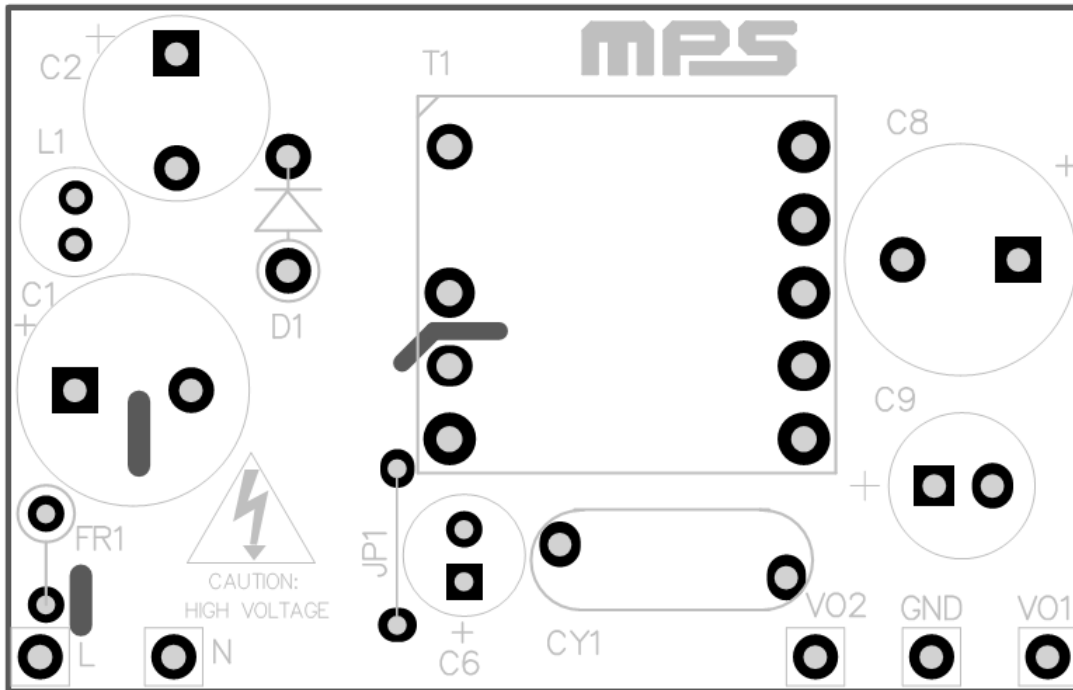

Figure 2—Top Layer

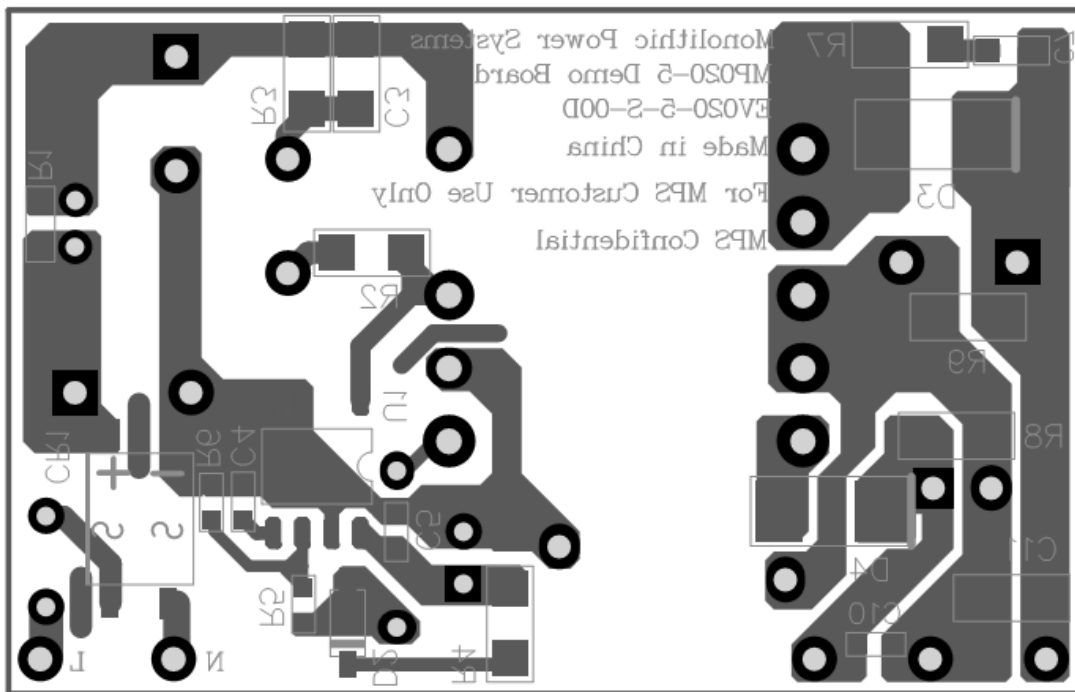

Figure 3—Bottom Layer

## CIRCUIT DESCRIPTION

The EV020-5-S-00D is configured in a single-stage Flyback topology, it uses primary-side-control which can mostly simplify the schematic and get a cost effective BOM. It can also achieve accurate constant voltage and acceptable cross regulation.

FR1 and CR1 compose the input stage. FR1 is used to protect for the component failure or some excessive short events, also it can restrain the inrush current.

C1, L1 and C2 compose  $\pi$  filter to guarantee the conducted EMI meet standard EN55022. R1 paralleled with L1 is used to damp resonant between L1 and C1, C2. R2, R3, D1 and C3 compose the snubber circuit to reduce drain-source voltage spike.

R4, C5, C6 and D2 are used as Vcc power supply. C5 is high frequency decoupling capacitor and should be placed with Vcc pin as near as possible.

R5 and R6 are resistor divider for detecting output voltage by sampling voltage on primary auxiliary winding.

CY1 is Y capacitor lowering common mode noise to make sure there is enough EMI margin. T1 is power transformer, the structure of which is also very important to pass EMI test.

D3 is rectifier for 18V output. Schottky diode is recommended for better efficiency and regulation. C7 and R7 are composed snubber for D3, which is to restrain the voltage spike between D3.

C8 and C11 are output capacitors for 18V output. C8 should be low ESR electrolytic capacitor for better load regulation. C11 is ceramic capacitor to reduce high frequency voltage ripple. R9 is dummy load to lower the output voltage of 18V rail at no load condition.

D4 is rectifier for 5V output. Schottky diode is recommended for better efficiency and regulation. Due to the output current is low at this rail and there is no obvious spike on D4, so no RC snubber is needed.

C9 and C10 are output capacitors for 5V output. C9 should be low ESR electrolytic capacitor for better load regulation. C10 is ceramic capacitor to reduce high frequency voltage ripple. R8 is dummy load to lower the output voltage of 5V rail at no load condition.

**EV020-5-S-00D BILL OF MATERIALS**

Qty	Ref	Value	Description	Package	Manufacturer	Manufacturer_P/N
1	C1	10 $\mu$ F	Capacitor;400V;20%	DIP	Ltec	TY Series 10uF/400V
1	C2	4.7 $\mu$ F	Capacitor;400V;20%	DIP	Beryl	4.7 $\mu$ F/400V
1	C3	470pF	Ceramic Capacitor;1000V;U2J	1206	muRata	GRM31B7U3A471JW31L
1	C4	0	Shorted			
1	C5	1 $\mu$ F	Ceramic Capacitor;25V;X7R	0603	muRata	GRM188R71E105KA12D
1	C6	22 $\mu$ F	Electrolytic Capacitor;50V	DIP	Jianghai	CD281L-50V22
1	C7	100pF	Ceramic Capacitor;250V;COG	0805	Murata	GRM21A5C2E101JW01D
1	C8	220 $\mu$ F	Electrolytic Capacitor;25V	DIP	Lelon	RXW221M1EBK-0811P
1	C9	100 $\mu$ F	Electrolytic Capacitor;10V	DIP	Jianghai	HCN1A101MB12
1	C10	1 $\mu$ F	Ceramic Capacitor;10V;X7R	0603	Murata	GRM188R71A105KA61D
1	C11	1 $\mu$ F	Ceramic Capacitor;25V;X7R	1206	TDK	C3216X7R1E105K
1	CR1	MB6F	Diode;600V;0.5A	SOP-4	Taiwan Semiconductor	MB6F
1	CY1	1nF	Y Capacitor;4000V;20%	DIP	Hongke	JN09E102MY02N
1	D1	FR107	Diode;1000V;1A	DO-41	Diodes	FR107
1	D2	BAV21W	Diode;200V;0.2A;	SOD-123	Diodes	BAV21W-7-F
1	D3	ES1D	Diode;200V;1A;	SMA	Taiwan Semiconductor	ES1D
1	D4	B140	Schottky Diode;40V;1A;	SMA	Diodes	B140
1	FR1	FKN1WSJT-52-10R	Fusible Resistor ;10 $\Omega$ /1W	DIP	Yageo	FKN1WSJT-52-10R
1	L1	1000 $\mu$ H	Inductor;1000 $\mu$ H;6 $\Omega$ ;0.25A	DIP	Wurth	7447462102
1	R1	10k $\Omega$	Film Resistor;5%;	0805	Yageo	RC0805JR-0710KL
1	R2	357 $\Omega$	Film Resistor;1%;1/4W	1206	Yageo	RC1206FR-07357RL
1	R3	150k $\Omega$	Film Resistor;1%;	1206	Panasonic	ERJ8ENF1503V
1	R4	10 $\Omega$	Film Resistor;5%;	1206	Yageo	RC1206JR-0710R
1	R5	28.7k $\Omega$	Film Resistor;1%;	0603	Yageo	RC0603FR-0728K7L
1	R6	13.7k $\Omega$	Film Resistor;1%;	0603	Yageo	RC0603FR-0713K7L
1	R7	20 $\Omega$	Film Resistor;5%;1/4W	1206		1206J0200T5E
1	R8	5.1k $\Omega$	Film Resistor;5%;1/4W	1206	LIZ	CR06T05NJ5K1
1	R9	20k $\Omega$	Resistor;5%; 1/4W	1206	LIZ	CR1206J40203G
1	T1		EE16 Transformer, Lp=1.8mH Np:Np_au:Nsec1:Nsec2 =134:16:17:7	EE16	Emei	FX0294
1	U1	MP020-5	Primary Side Regulator	SOIC8-7A	MPS	MP020-5GS R3

## TRANSFORMER SPECIFICATION

### Electrical Diagram

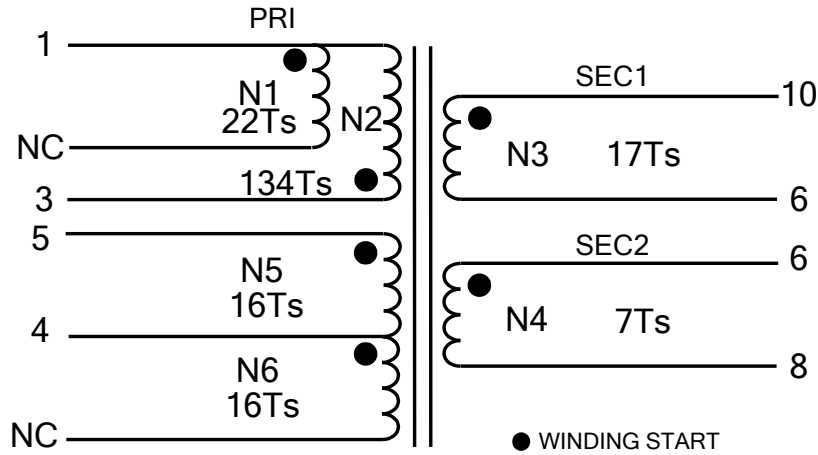

Figure 4—Transformer Electrical Diagram

**Notes:**

1. N1 is with 2 wires which are paralleled together.
2. N3 and N4 are both triple insulation wires.
3. One layer tape is between each layer winding. 3 layers tape is at the outside of last winding

### Winding Diagram

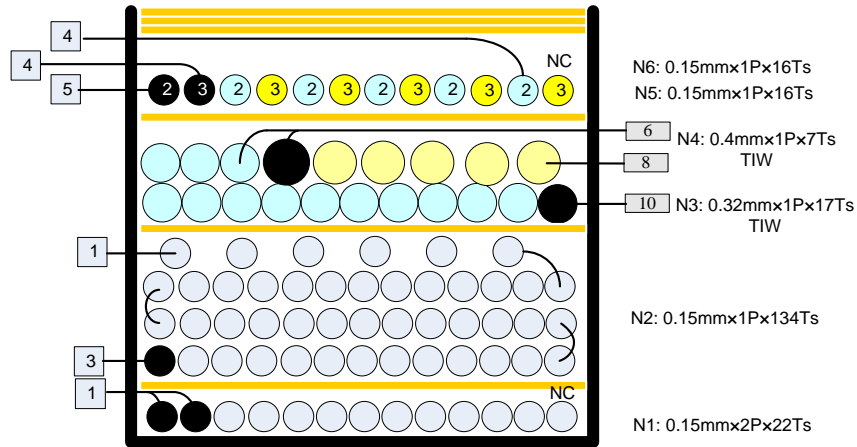

Figure 5—Winding Diagram

**Winding Order**

Tapes (T)	Winding	Start-End	Wire Diameter (Ø)	Turns ( T )	Tube
0	N1	1—> NC	0.15mm*2	22	None
1	N2	3—> 1	0.15mm*1	134	None
1	N3	10—> 6	0.32mm*1 TIW	17	None
1	N4	6—> 8	0.4mm*1 TIW	7	None
3	N5,	5—> 4	0.15mm*1	16	None
	N6	4—> NC	0.15mm*1	16	

**Electrical Specifications**

<b>Electrical Strength</b>	60 second, 60Hz, from PRI. to SEC.	3000VAC
	60 second, 60Hz, from PRI. to CORE.	500VAC
	60 second, 60Hz, from SEC. to CORE.	3000VAC
<b>Primary Inductance</b>	Pins 1 - 3, all other windings open, measured at 60kHz, 0.1 VRMS	1.8mH±10%
<b>Primary Leakage Inductance</b>	Pins 1 - 3 with all other pins shorted, measured at 60kHz. 0.1 VRMS	50µH±10%

**Materials**

Item	Description
1	Core: EE16, UI=2300±25%, AL=73.2.4nH/N <sup>2</sup> ±3% GAPPED, or equivalent
2	Bobbin: EE16, 5+5PIN 1 SECT TH, UL94V-0
3	Wire:Φ0.15mm,, 2UEW, Class B
4	Triple Insulation Wire: Φ0.40mm, TIW
5	Triple Insulation Wire: Φ0.32mm TIW
6	Tape: 8.0mm(W)×0.06mm(TH)
7	Varnish: JOHN C. DOLPH CO, BC-346A or equivalent
8	Solder Bar: CHEN NAN: SN99.5/Cu0.5 or equivalent



## EVB TEST RESULTS

### Performance Data

Ta=25°C, unless otherwise noted.

#### Efficiency and Load/Line Regulation (Test at the end of board)

	Pin (W)	V <sub>OUT1</sub> (V)	I <sub>OUT1</sub> (A)	V <sub>OUT2</sub> (V)	I <sub>OUT2</sub> (A)	Efficiency	V <sub>OUT1</sub> Regulation	V <sub>OUT2</sub> Regulation
Vin=85Vac/60Hz	0.03097	17.83	0	4.95	0	0.00%	-0.94%	-1.00%
	7.2945	17.6	0.3	5	0.1	79.23%	-2.22%	0.00%
	1.3279	17.74	0.03	4.7	0.1	75.47%	-1.44%	-6.00%
	0.72949	17.54	0.03	5.04	0.005	75.59%	-2.56%	0.80%
	6.6718	17.54	0.3	5.11	0.005	79.25%	-2.56%	2.20%

	Pin (W)	V <sub>OUT1</sub> (V)	I <sub>OUT1</sub> (A)	V <sub>OUT2</sub> (V)	I <sub>OUT2</sub> (A)	Efficiency	V <sub>OUT1</sub> Regulation	V <sub>OUT2</sub> Regulation
Vin=115Vac/60Hz	0.03423	17.81	0	4.95	0	0.00%	-1.06%	-1.00%
	7.0858	17.57	0.3	4.99	0.1	79.22%	-2.22%	-0.20%
	1.3112	17.71	0.03	4.69	0.1	76.29%	-1.61%	-6.20%
	0.7226	17.54	0.03	5.02	0.005	76.29%	-2.56%	0.40%
	6.4962	17.54	0.3	5.11	0.005	81.39%	-2.56%	2.20%

	Pin (W)	V <sub>OUT1</sub> (V)	I <sub>OUT1</sub> (A)	V <sub>OUT2</sub> (V)	I <sub>OUT2</sub> (A)	Efficiency	V <sub>OUT1</sub> Regulation	V <sub>OUT2</sub> Regulation
Vin=230Vac/50Hz	0.03952	17.86	0	4.96	0	0.00%	-0.78%	-0.80%
	7.0653	17.6	0.3	5	0.1	81.81%	-2.22%	0.00%
	1.3211	17.74	0.03	4.69	0.1	75.79%	-1.44%	-6.20%
	0.72883	17.53	0.03	5.02	0.005	75.60%	-2.61% <span style="color:red">Δ</span>	0.40%
	6.471	17.56	0.3	5.12	0.005	81.80%	-2.44%	2.40%

	Pin (W)	V <sub>OUT1</sub> (V)	I <sub>OUT1</sub> (A)	V <sub>OUT2</sub> (V)	I <sub>OUT2</sub> (A)	Efficiency	V <sub>OUT1</sub> Regulation	V <sub>OUT2</sub> Regulation
Vin=265Vac/50Hz	0.04261	17.82	0	4.95	0	0.00%	-1.00%	-1.00%
	7.0915	17.59	0.3	5	0.1	81.46%	-2.28%	0.00%
	1.3332	17.71	0.03	4.68	0.1	74.95%	-1.61%	-6.40% <span style="color:red">Δ</span>
	0.73666	17.54	0.03	5.02	0.005	74.84%	-2.56%	0.40%
	6.5233	17.57	0.3	5.12	0.005	81.20%	-2.39%	2.40%

**Notes:**

1. The red triangle means the worst case in table.

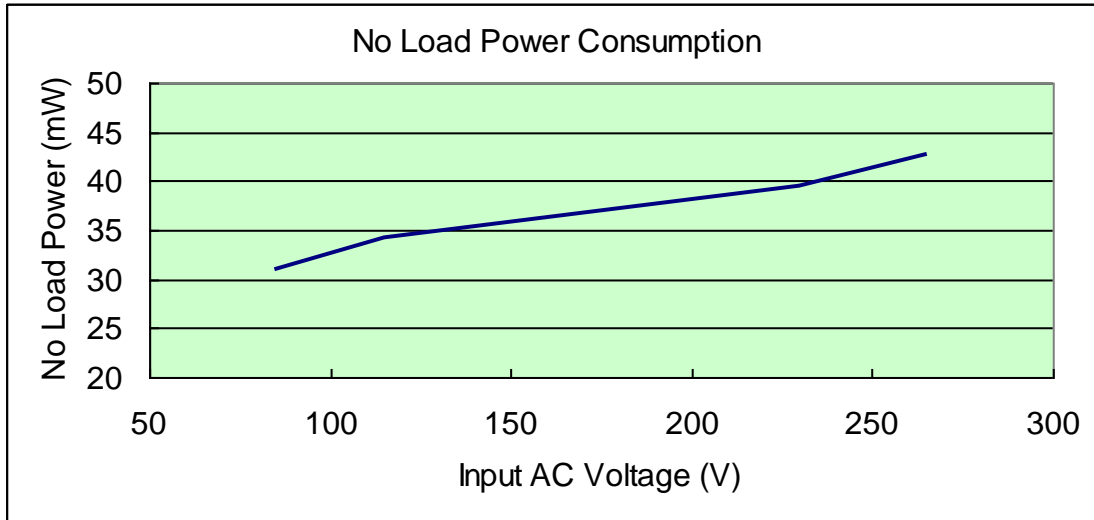
**No Load Consumption**

**Electric Strength Test**

Primary circuit to secondary circuit electric strength testing was completed according to IEC61000-4-2.

Input and output was shorted respectively. 3000VAC/50Hz sine wave applied between input and output for 1min, and operation was verified.

**Surge Test**

Line to Line 1kV and Line to Power Earth 1kV surge testing was completed according to IEC61000-4-5.

Input voltage was set at 230VAC/50Hz. Output was loaded at full load and operation was verified following each surge event.

Surge Level (V)	Input Voltage (VAC)	Injection Location	Injection Phase (°)	Test Result (Pass/Fail)
1000	230	L to N	90	Pass
-1000	230	L to N	270	Pass
1000	230	L to PE	90	Pass
-1000	230	L to PE	270	Pass
1000	230	N to PE	90	Pass
-1000	230	N to PE	270	Pass

**Conducted EMI Test**

Test with 230Vac input and full load condition

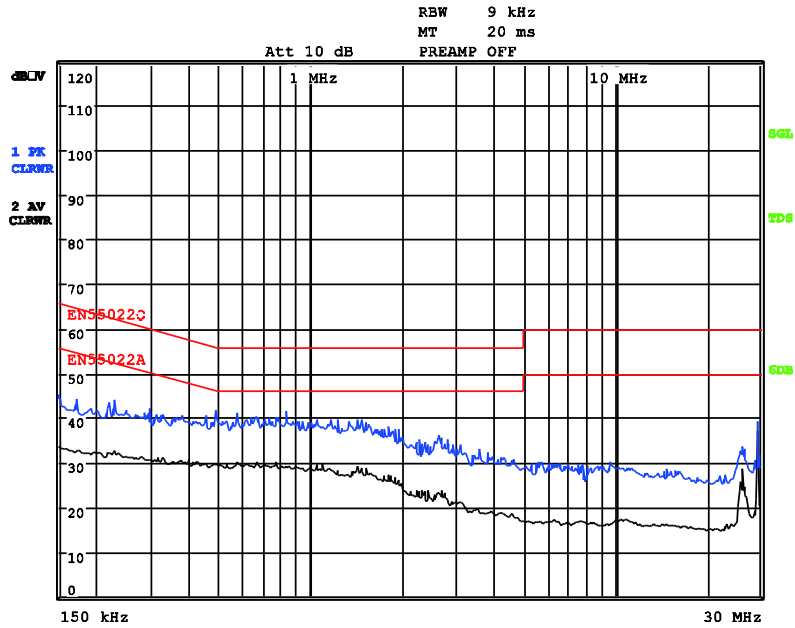

**230Vac, 50Hz, Maximum Load, L Line, Output GND floats, EN55022 Limits**

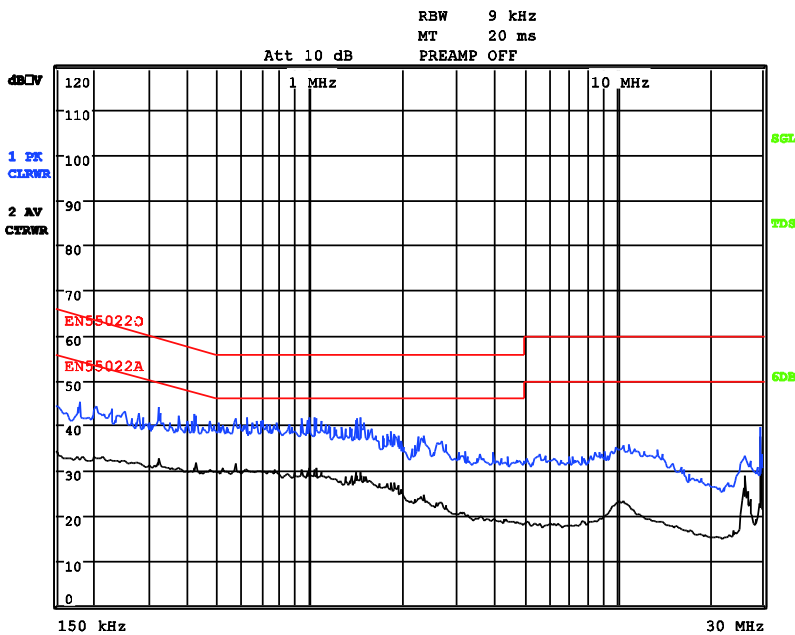

**230Vac, 50Hz, Maximum Load, N Line, Output GND floats, EN55022 Limits**

Test with 115Vac input and full load condition

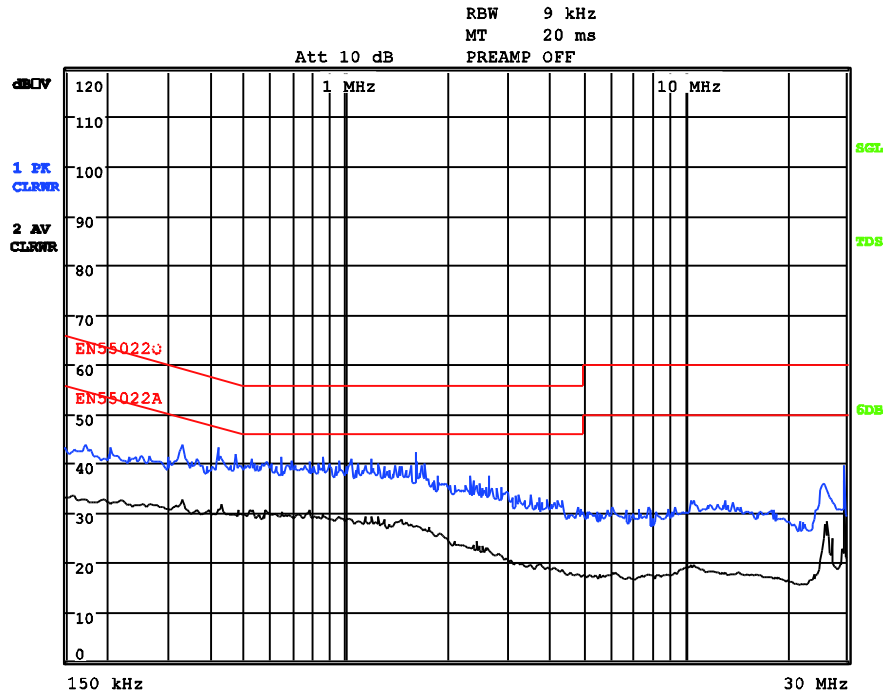

115Vac, 60Hz, Maximum Load, L Line, Output GND floats, EN55022 Limits

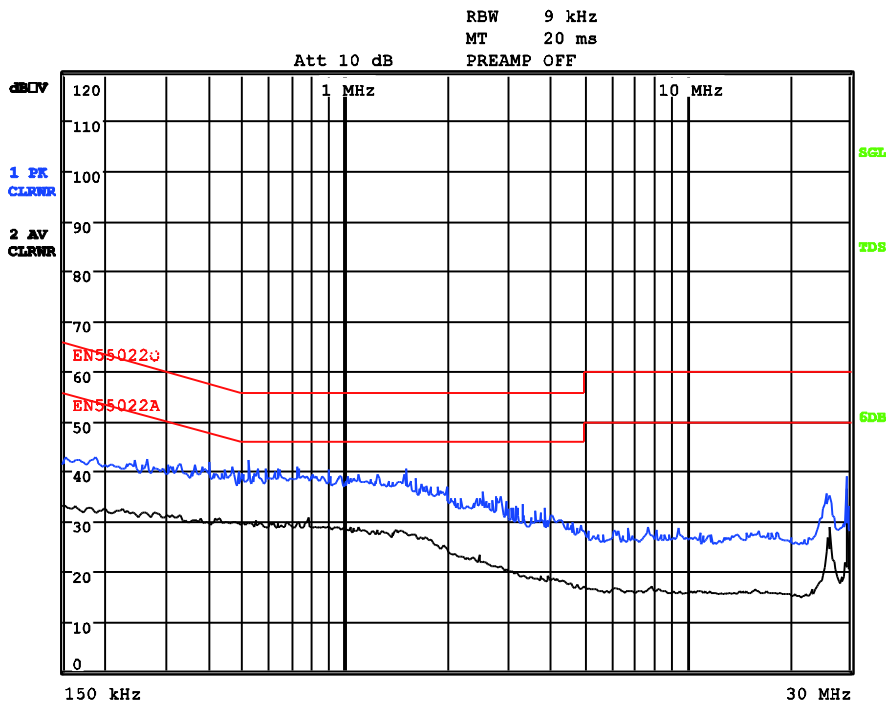

115Vac, 60Hz, Maximum Load, N Line, Output GND floats, EN55022 Limits

**Thermal Test**

Test is conducted at ambient temperature of 25°C, 85Vac/60Hz input.

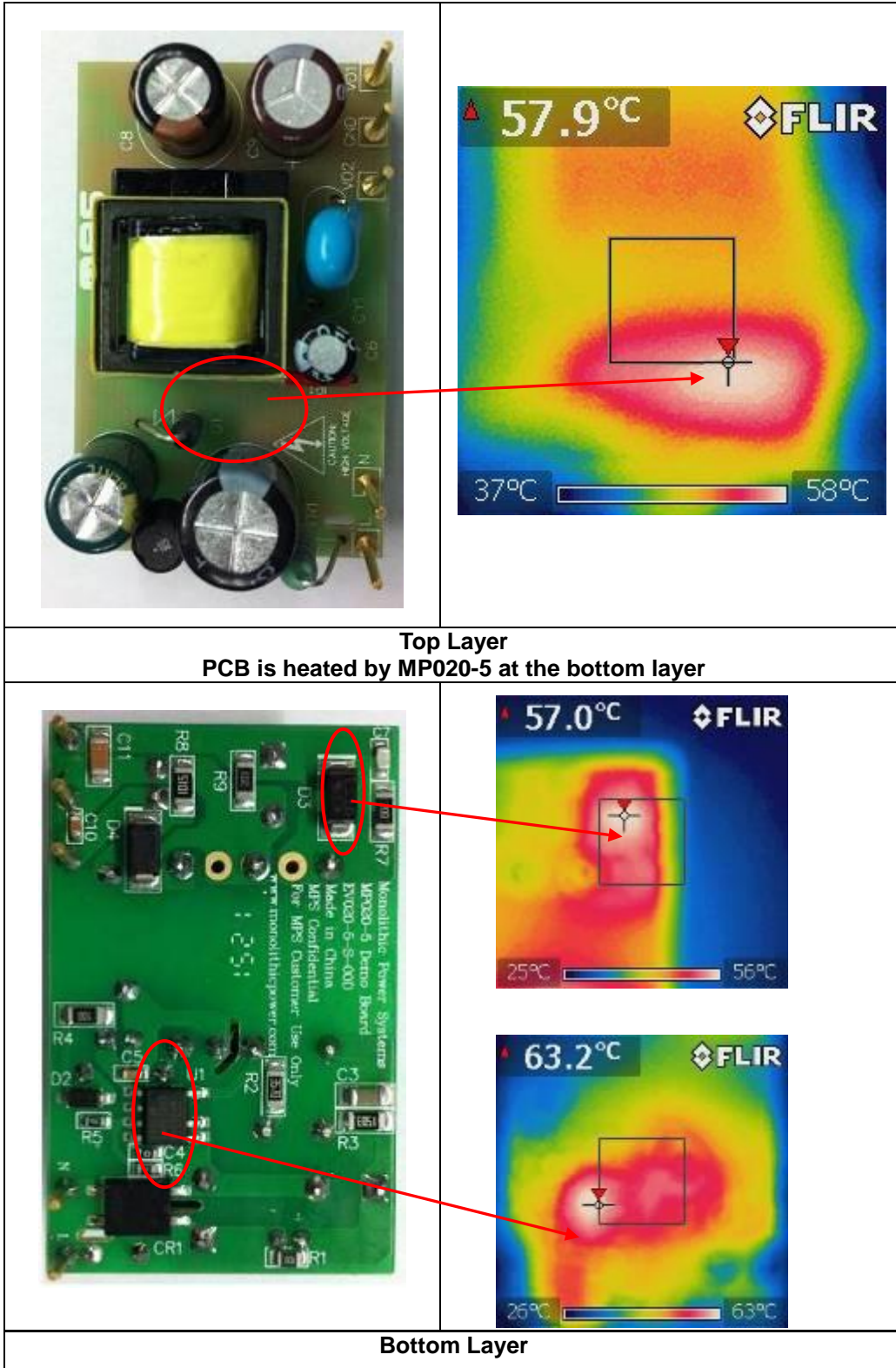

## EVB TEST RESULTS

Performance waveforms are tested on the evaluation board.

$V_{IN}=115VAC/60Hz$ ,  $V_{OUT1}=18V$ ,  $I_{OUT1}=0.3A$ ,  $V_{OUT2}=5V$ ,  $I_{OUT2}=0.1A$ , CC Mode Load,  $T_A=25^{\circ}C$ .

**Steady State**

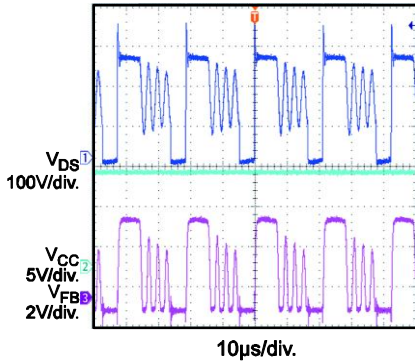

**Turn On Delay**

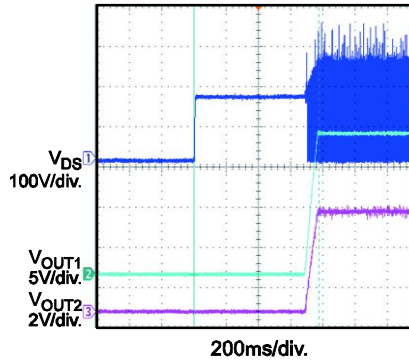

**Output1 Rise Time**

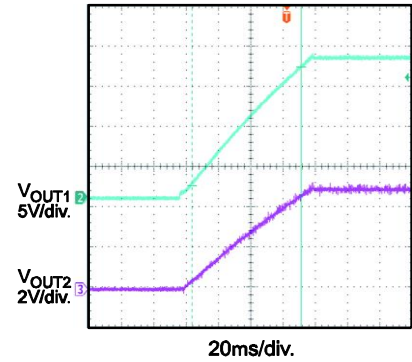

**Output2 Rise Time**

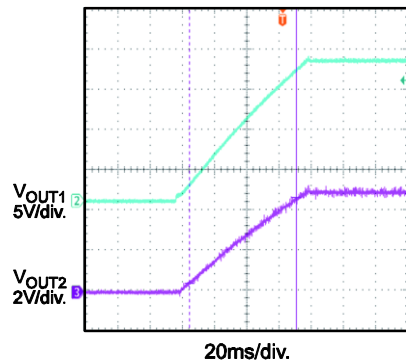

**OCP Entry**

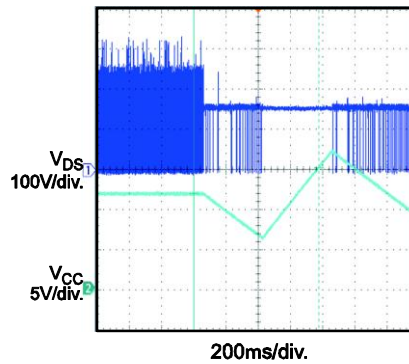

**OCP Recovery**

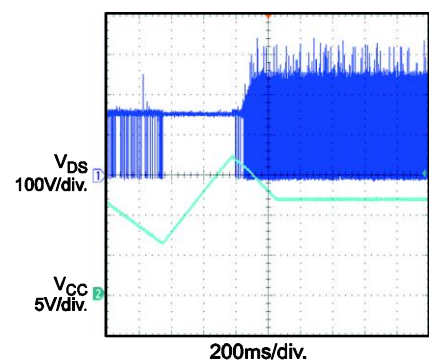

**OCP Entry**

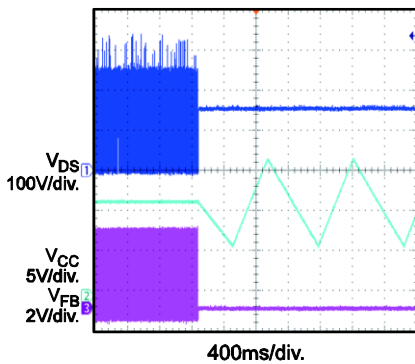

**OCP Recovery**

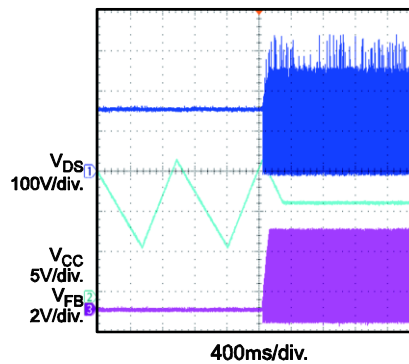

**Output Voltage Ripple**

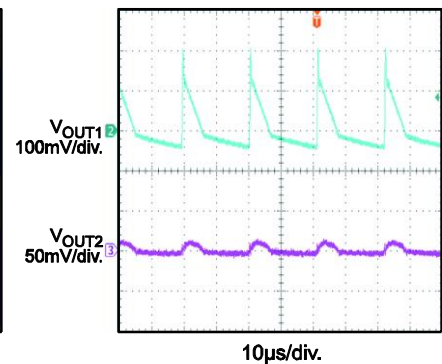

### EVB TEST RESULTS (continued)

Performance waveforms are tested on the evaluation board.

$V_{IN}=230VAC/50Hz$ ,  $V_{OUT1}=18V$ ,  $I_{OUT1}=0.3A$ ,  $V_{OUT2}=5V$ ,  $I_{OUT2}=0.1A$ , CC Mode Load,  $T_A=25^{\circ}C$ .

**Steady State**

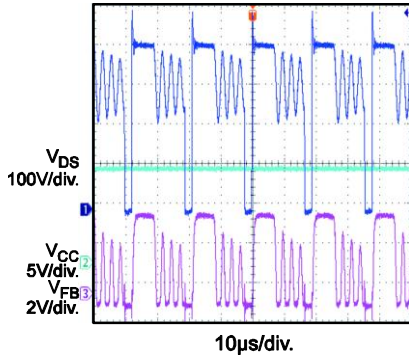

**Turn On Delay**

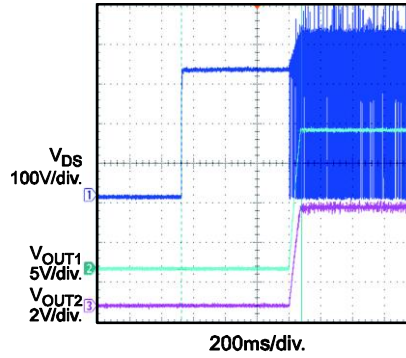

**Output1 Rise Time**

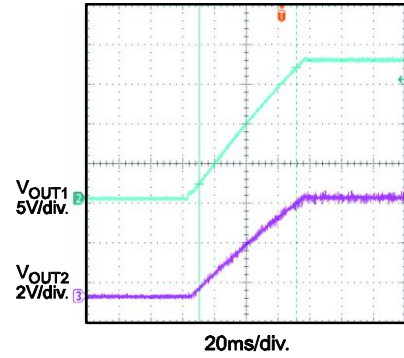

**Output2 Rise Time**

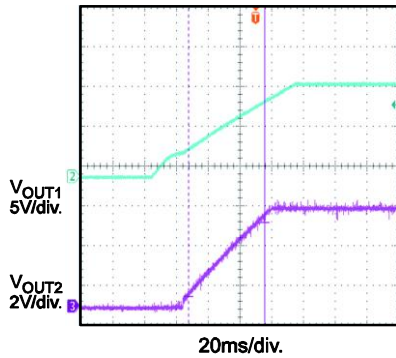

**OCP Entry**

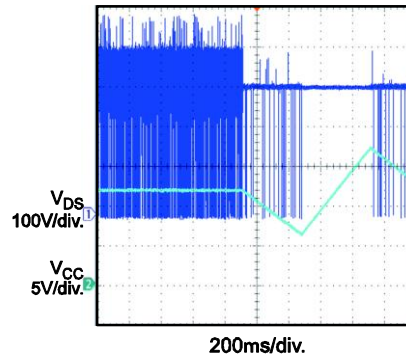

**OCP Recovery**

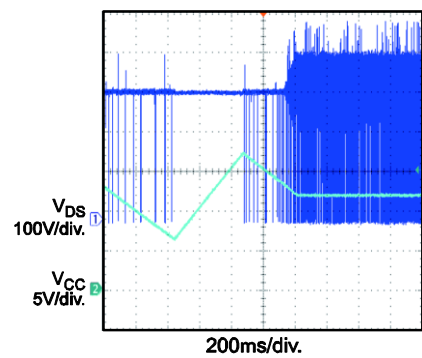

**OCP Entry**

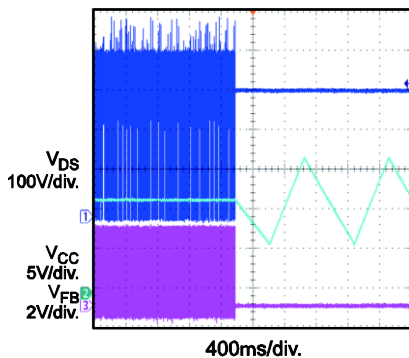

**OCP Recovery**

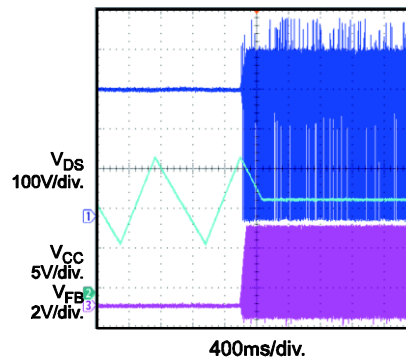

**Output Voltage Ripple**

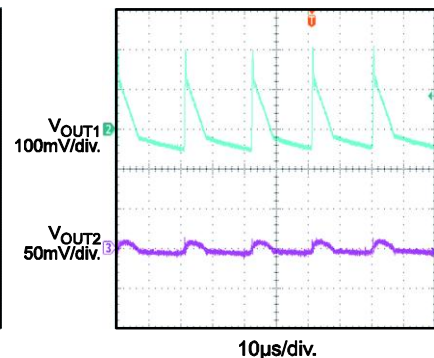

## QUICK START GUIDE

1. Preset Power Supply to  $85\text{VAC} \leq V_{\text{IN}} \leq 265\text{VAC}$ .
2. Turn Power Supply off.
3. Connect the Line and Neutral terminals of the power supply output to L and N port. For three-wire input application, make OUTPUT GND connected to Earth.
4. Connect Different Load to Corresponding Outputs :
  - a. Positive 1 (+): 18V OUT
  - b. Positive 2 (+): 5V OUT
  - c. Negative (-): GND
5. Turn Power Supply on after making connections.

**NOTICE:** The information in this document is subject to change without notice. Please contact MPS for current specifications. Users should warrant and guarantee that third party Intellectual Property rights are not infringed upon when integrating MPS products into any application. MPS will not assume any legal responsibility for any said applications.



## X-ON Electronics

Largest Supplier of Electrical and Electronic Components

*Click to view similar products for* [Power Management IC Development Tools](#) *category:*

*Click to view products by* [Monolithic Power Systems](#) *manufacturer:*

Other Similar products are found below :

[EVAL-ADM1168LQEBZ](#) [EVB-EP5348UI](#) [MIC23451-AAAYFL EV](#) [MIC5281YMME EV](#) [DA9063-EVAL](#) [ADP122-3.3-EVALZ](#) [ADP130-0.8-EVALZ](#) [ADP130-1.2-EVALZ](#) [ADP130-1.5-EVALZ](#) [ADP130-1.8-EVALZ](#) [ADP1712-3.3-EVALZ](#) [ADP1714-3.3-EVALZ](#) [ADP1715-3.3-EVALZ](#) [ADP1716-2.5-EVALZ](#) [ADP1740-1.5-EVALZ](#) [ADP1752-1.5-EVALZ](#) [ADP1828LC-EVALZ](#) [ADP1870-0.3-EVALZ](#) [ADP1871-0.6-EVALZ](#) [ADP1873-0.6-EVALZ](#) [ADP1874-0.3-EVALZ](#) [ADP1882-1.0-EVALZ](#) [ADP199CB-EVALZ](#) [ADP2102-1.25-EVALZ](#) [ADP2102-1.875EVALZ](#) [ADP2102-1.8-EVALZ](#) [ADP2102-2-EVALZ](#) [ADP2102-3-EVALZ](#) [ADP2102-4-EVALZ](#) [ADP2106-1.8-EVALZ](#) [ADP2147CB-110EVALZ](#) [AS3606-DB](#) [BQ24010EVM](#) [BQ24075TEVM](#) [BQ24155EVM](#) [BQ24157EVM-697](#) [BQ24160EVM-742](#) [BQ24296MEVM-655](#) [BQ25010EVM](#) [BQ3055EVM](#) [NCV891330PD50GEVB](#) [ISLUSBI2CKIT1Z](#) [LM2744EVAL](#) [LM2854EVAL](#) [LM3658SD-AEV/NOPB](#) [LM3658SDEV/NOPB](#) [LM3691TL-1.8EV/NOPB](#) [LM4510SDEV/NOPB](#) [LM5033SD-EVAL](#) [LP38512TS-1.8EV](#)