

DESCRIPTION

The EV161-S-00A Evaluation Board is designed to demonstrate the capabilities of MP161. The MP161 is a primary-side constant voltage regulator providing accurate constant voltage (CV) regulation without Opto-coupler.

The EV161-S-00A Evaluation Board is designed as Buck application. EV161-S-00A typically drives a 12V/70mA, 5V/50mA output from 85VAC to 265VAC, at 60/50Hz.

The EV161-S-00A has an excellent efficiency and meets 2kV IEC61000-4-5 surge immunity and EN55022 conducted EMI requirements.

The MP161 is dedicated to home automation, industrial automation and any other applications that adopt relays and MCUs. It integrates a 700V switching regulator, a low dropout linear regulator, and two channel relay drivers. It also has a special standby mode to minimize the standby power.

MP161AGS-5 is used in this evaluation board, it is in SOIC16 package. This board can be used for MP161B and MP161C evaluation.

ELECTRICAL SPECIFICATION

Parameter	Symbol	Value	Units
Input Voltage	V_{IN}	85 to 265	VAC
Output Voltage1	V_{OUT1}	12	V
Output Current1	I_{OUT1}	70	mA
Output Voltage2	V_{OUT2}	5	V
Output Current2	I_{OUT2}	50	mA

FEATURES

- **700V SWITCHING REGULATOR**
 - Integrated 700V MOSFET and current source;
 - CV regulation with internal loop compensation;
 - Optimized light load efficiency by frequency modulation;
 - Standby mode;
 - Anti audible noise operation by peak current modulation;
 - Adjustable, or fixed 12V output;
 - Low operating current;
 - Protections including over temperature protection (OTP), short circuit protection (SCP), over load protection (OLP) and over voltage protection (OVP).
- **LOW DROPOUT LINEAR REGULATOR**
 - Up to 30V input voltage;
 - Fixed output, with options of 3.3V and 5V;
 - Over temperature protection (OTP).
- **RELAY DRIVER**
 - 2Ω on state resistance
 - Rail voltage up to 30V;
 - Integrated freewheeling diode;
 - Nominal off driver.

APPLICATIONS

- Home/Industrial Automation
- Small Appliance

All MPS parts are lead-free, halogen free and adhere to the RoHS directive. For MPS green status, please visit MPS website under Quality Assurance. "MPS" and "The Future of Analog IC Technology", are Registered Trademarks of Monolithic Power Systems, Inc.



Warning: Although this board is designed to satisfy safety requirements, the engineering prototype has not been agency approved. Therefore, all testing should be performed using an isolation transformer to provide the AC input to the prototype board.

EV161-S-00A EVALUATION BOARD

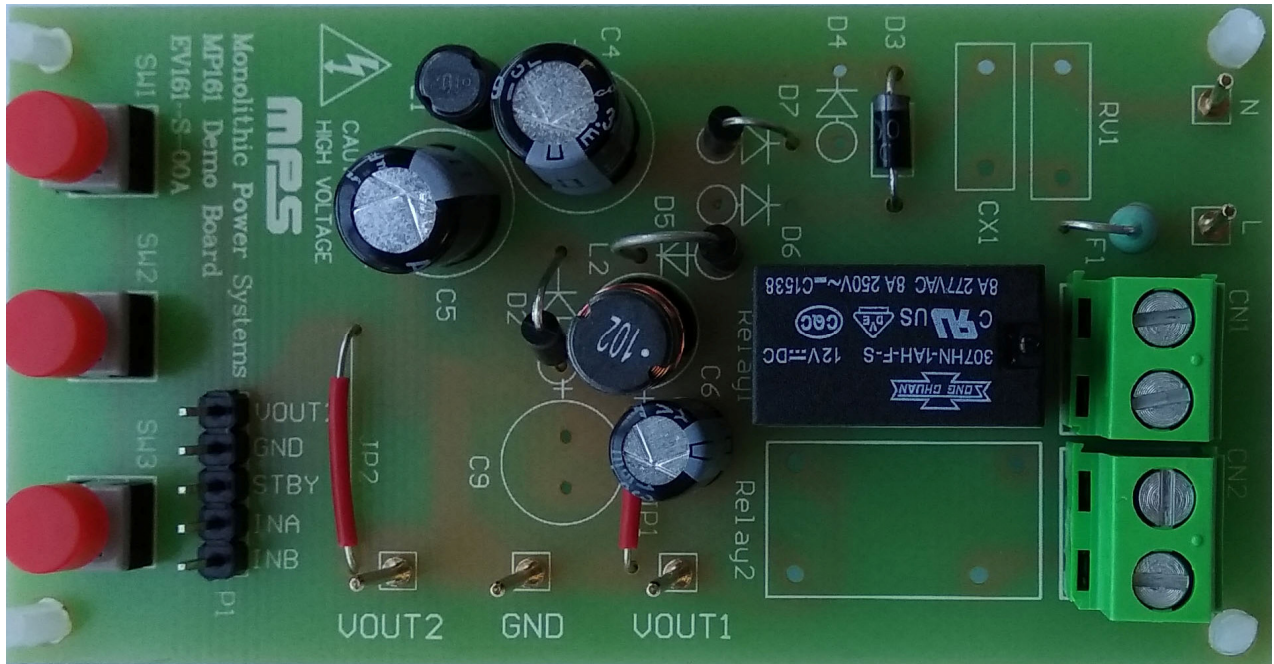

TOP VIEW

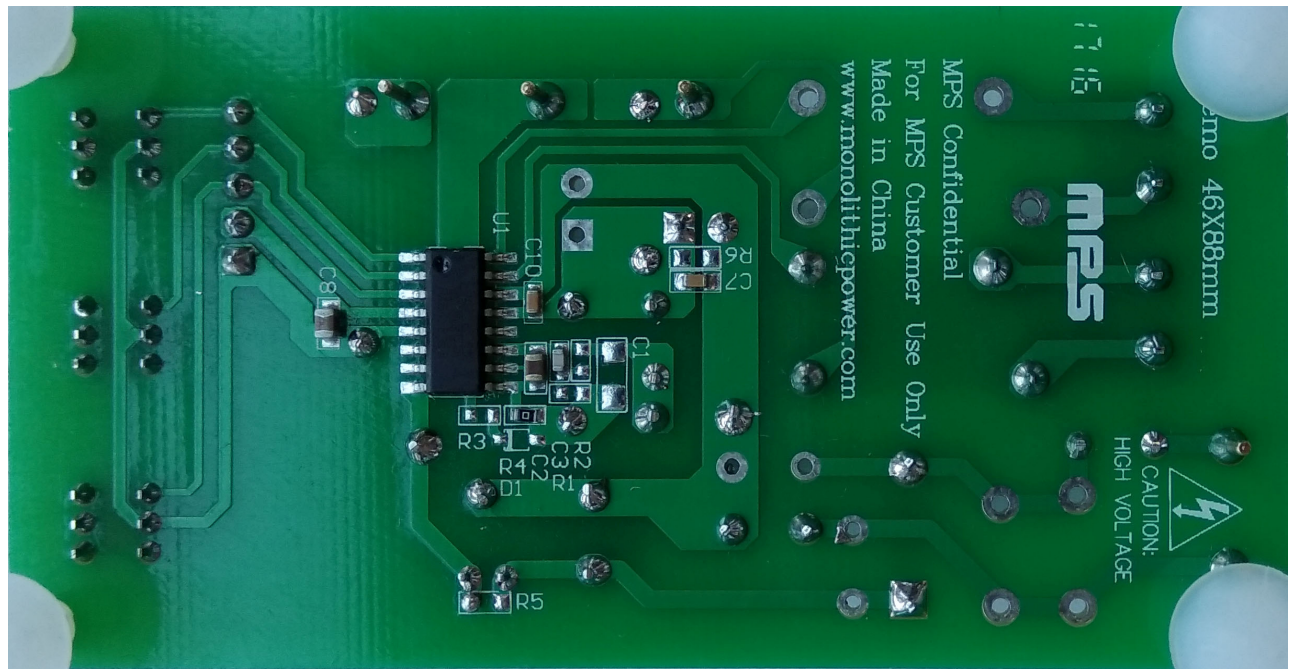

BOTTOM VIEW

(L x W x H) 88mm x 46mm x 20mm

Board Number	MPS IC Number
EV161-S-00A	MP161AGS-5

EVALUATION BOARD SCHEMATIC

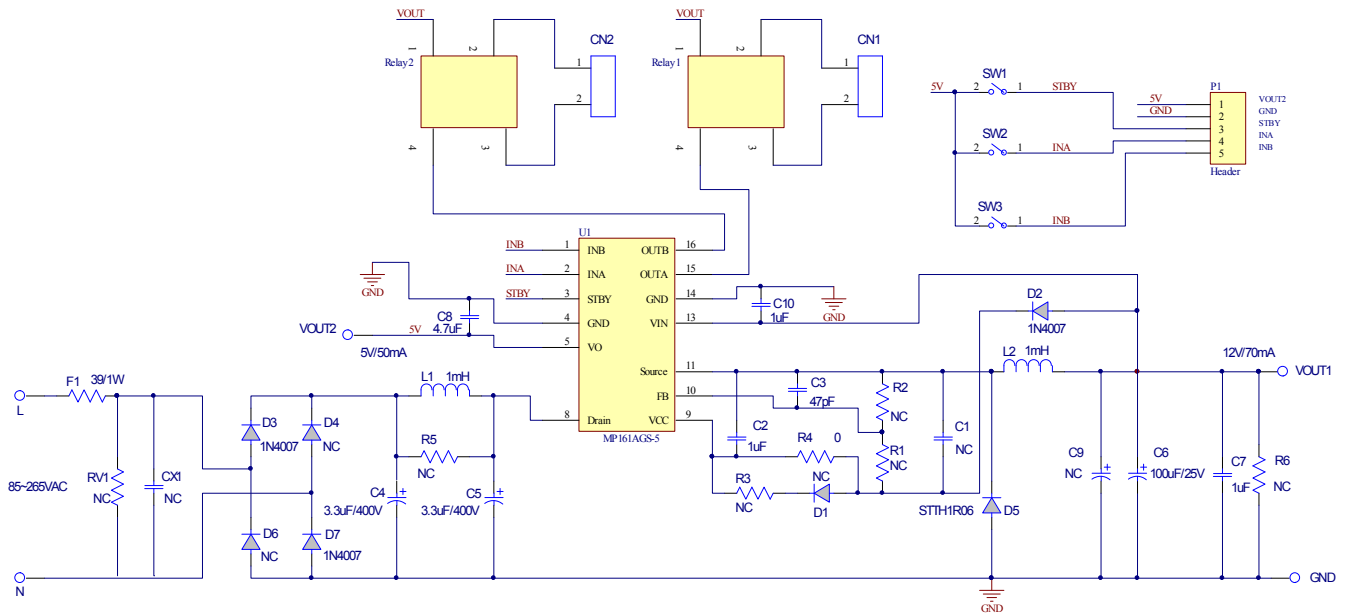

Figure 1—Schematic

PCB LAYOUT (SINGLE-SIDED)

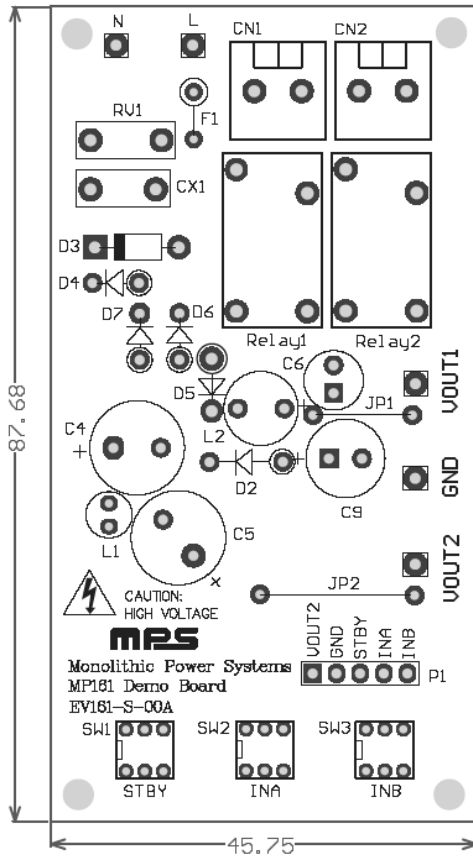

Figure 2—Top Layer

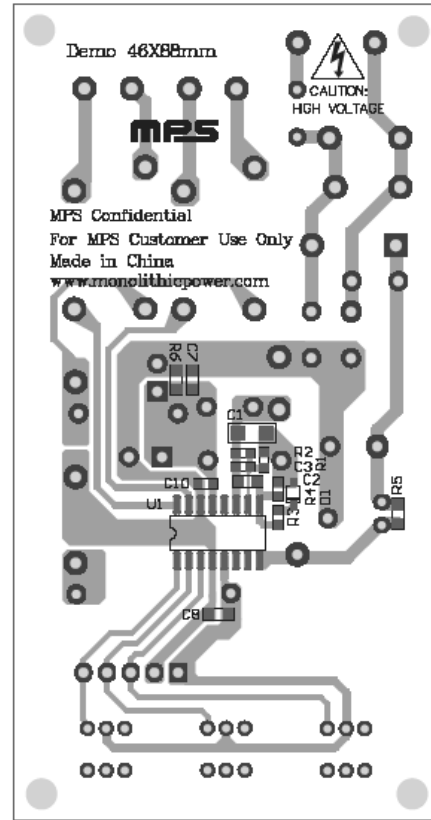

Figure 3—Bottom Layer

EV161-S-00A BILL OF MATERIALS

Quantity	Designator	Value	Description	Package	Manufacture	Manufacture_PN
0	C1	NC				
1	C2	1uF	Ceramic Capacitor; 50V; X7R	0805	muRata	GRM21BR71H105 KA12L
1	C3	47pF	Ceramic Capacitor; 50V; X7R	0603	muRata	GRM188R71H102 KA01D
2	C4, C5	3.3uF	Electrolytic Capacitor; 400V; 20%	DIP	Rubycon	400LLE3R3MEFC8 X11
1	C6	100uF	Electrolytic Capacitor; 25V	DIP	Rubycon	25YXF100M6.3X11
2	C7, C10	1uF	Ceramic Capacitor; 25V; X7R	0603	muRata	GRM188R71E105 KA12D
1	C8	4.7uF	Ceramic Capacitor; 10V; X5R	0805	TDK	C2012X5R3A475K
0	C9	NC				
2	CN1, CN2	691216510002	Connector	DIP	Würth	691216510002
3	D2, D3, D7	1N4007	Diode; 1000V; 1A	DO-41	Diodes	1N4007
1	D5	STTH1R06	Diode; 600V; 1A	DO-41	ST	STTH1R06
1	F1	39	Resistor; 5%; 1W	AXIAL	Yageo	FKN1WSJT-52-39 R
2	JP1, JP2	Jumper				
1	L1	1mH	Inductor; 1mH; 6Ω; 250mA	DIP	Würth	7447462102
1	L2	1mH	Inductor; 1mH; 2.5Ω; 420mA	DIP	Würth	744743102
0	R1	NC				
0	R2	NC				
1	R4	0	Film Resistor;5%	0603	Yageo	RC0603JR-070RL
0	R5	NC				
0	R6	NC				
1	P1	Pin header	5pin	DIP	Any	Any
1	Relay1	307HN-1AH-F-S 12VDC	Relay	DIP	Songchuan	307HN-1AH-F-S 12VDC
0	Relay2	NC				
3	SW1, SW2, SW3	Switch		DIP	Any	Any
1	U1	MP161	Primary side regulator	SOIC16	MPS	MP161AGS-5
5	L, N, VOUT1, VOUT2, GND	1mm	Pin Connector			

EVB TEST RESULTS

Performance waveforms are tested on the valuation board with MP161AGS-5. $V_{IN} = 85\sim 265VAC$, $V_{OUT1} = 12V$, $I_{OUT1} = 70mA$, $V_{OUT2} = 5V$, $I_{OUT2} = 50mA$, $T_A = 27^\circ C$, unless otherwise noted.

No Load Consumption

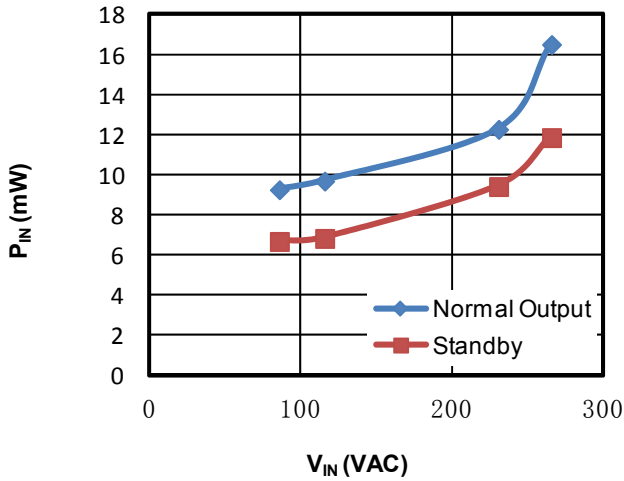

Efficiency

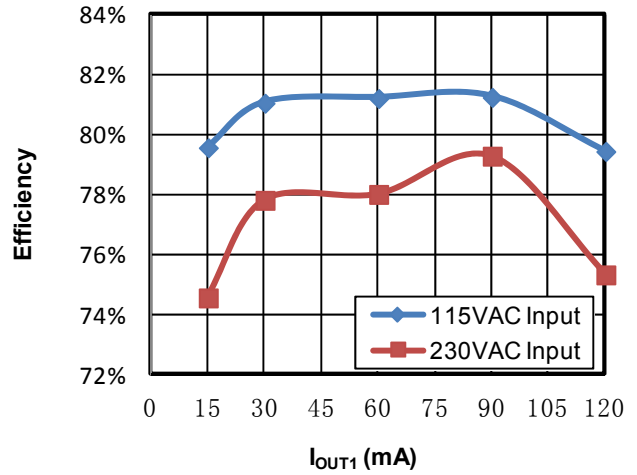

Thermal Performance

$V_{IN}=85VAC$, Full Load

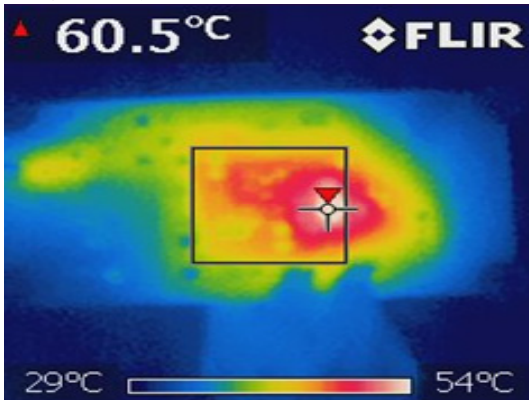

Thermal Performance

$V_{IN}=265VAC$, Full Load

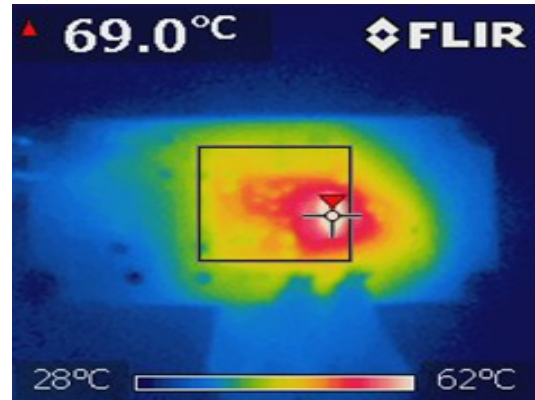

Conducted EMI

$V_{IN}=230VAC$, Full Load, Live Wire

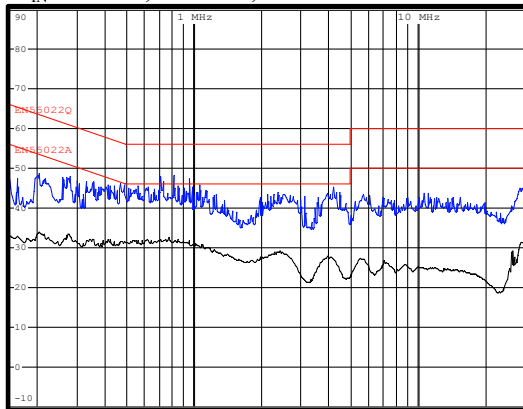

Conducted EMI

$V_{IN}=230VAC$, Full Load, Neutral Wire

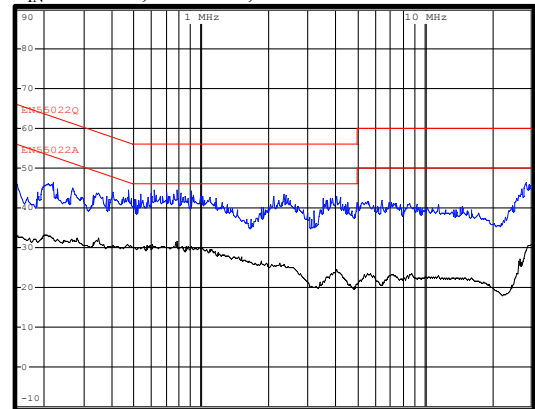

EVb TEST RESULTS

Performance waveforms are tested on the valuation board with MP161AGS-5. $V_{IN} = 230VAC$, $V_{OUT1} = 12V$, $I_{OUT1} = 70mA$, $V_{OUT2} = 5V$, $I_{OUT2} = 50mA$, $T_A = 27^{\circ}C$, unless otherwise noted.

Normal Operation

Full Load

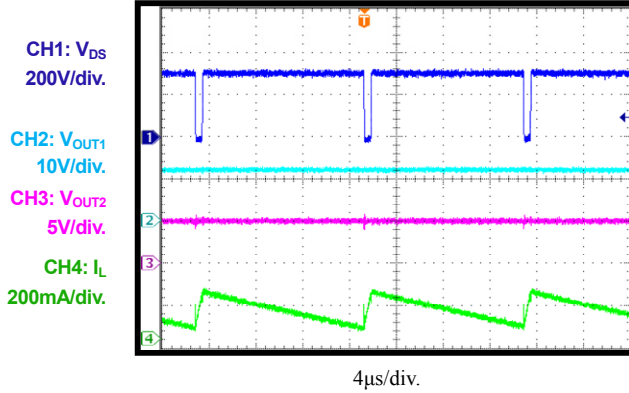

Start-Up

No Load

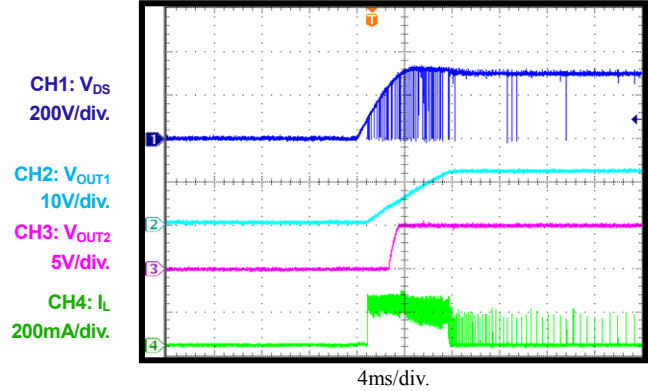

Start-Up

Full Load

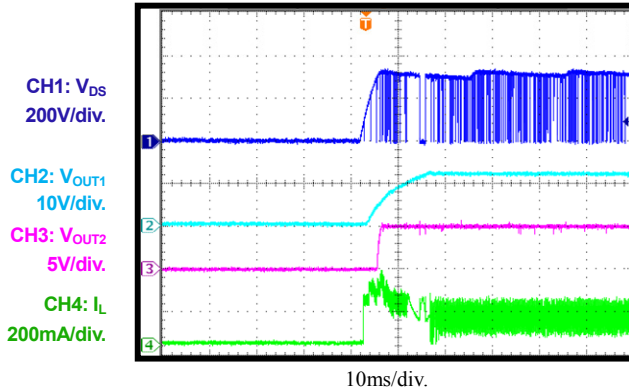

V_{OUT1} Short Circuit

Full Load

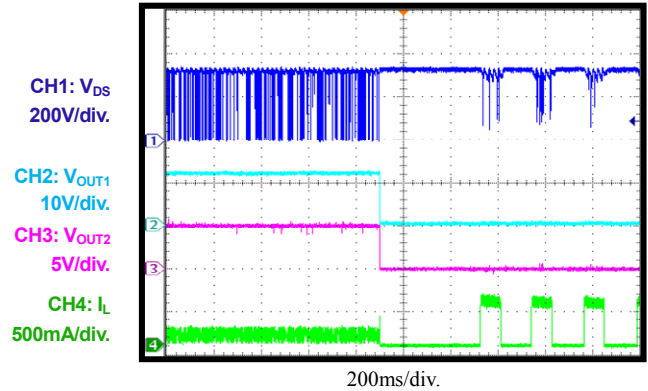

V_{OUT2} Short Circuit

Full Load

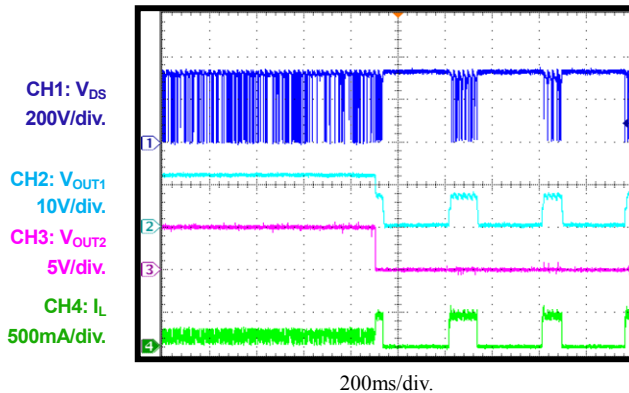

V_{OUT1} OVP

No Load

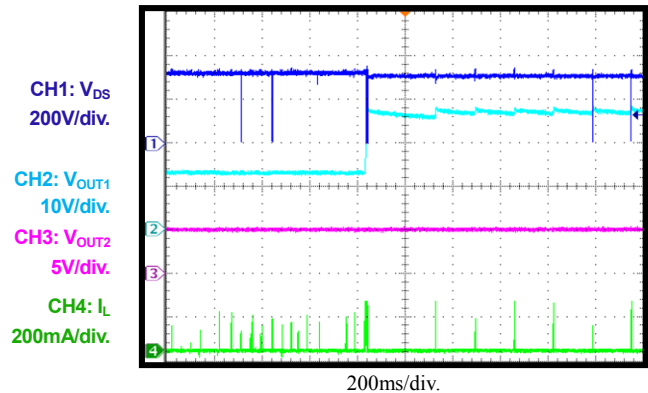

EVB TEST RESULTS

Performance waveforms are tested on the valuation board with MP161AGS-5. $V_{IN} = 230VAC$, $V_{OUT1} = 12V$, $I_{OUT1} = 70mA$, $V_{OUT2} = 5V$, $I_{OUT2} = 50mA$, $T_A = 27^{\circ}C$, unless otherwise noted.

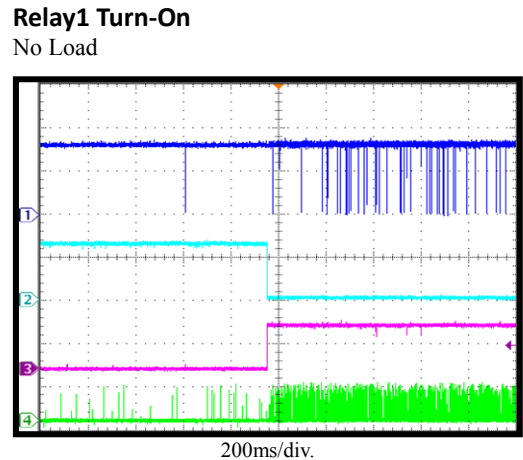
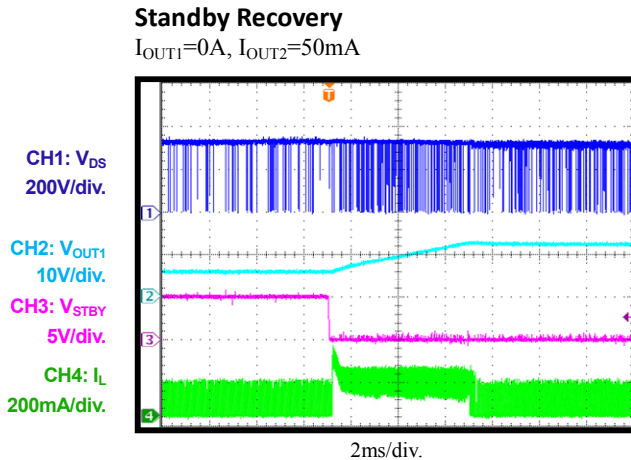
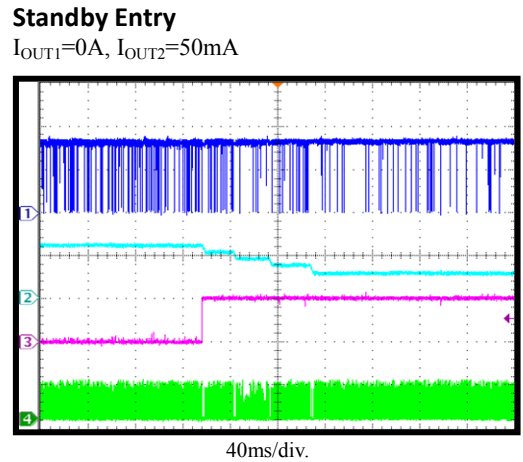
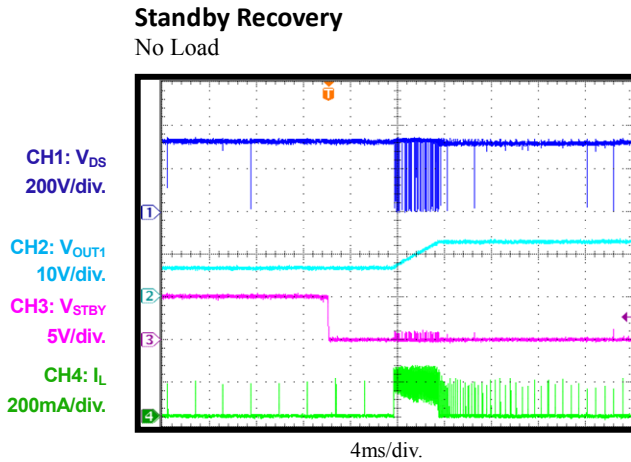
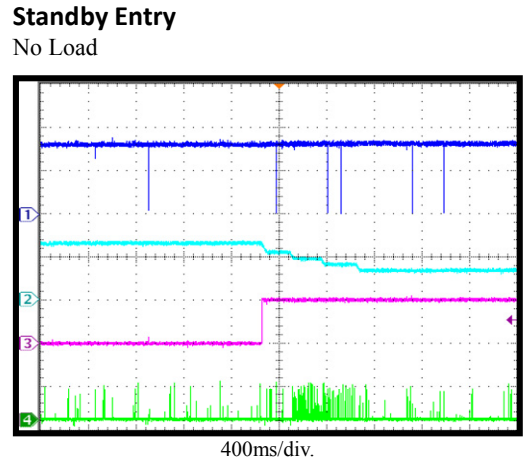
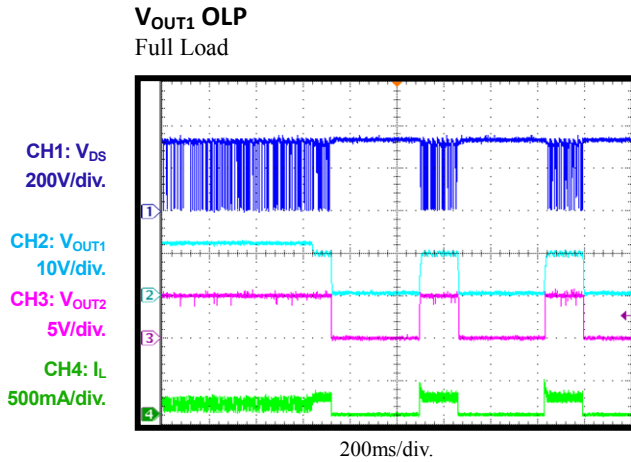

EVB TEST RESULTS

Performance waveforms are tested on the valuation board with MP161AGS-5. $V_{IN} = 230VAC$, $V_{OUT1} = 12V$, $I_{OUT1} = 70mA$, $V_{OUT2} = 5V$, $I_{OUT2} = 50mA$, $T_A = 27^{\circ}C$, unless otherwise noted.

Relay1 Turn-Off

No Load

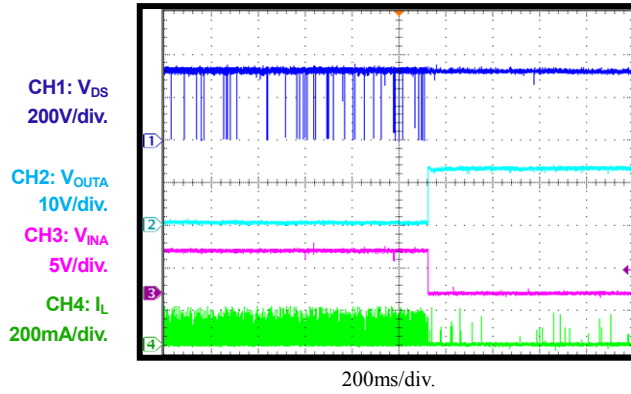

Relay2 Turn-On

No Load

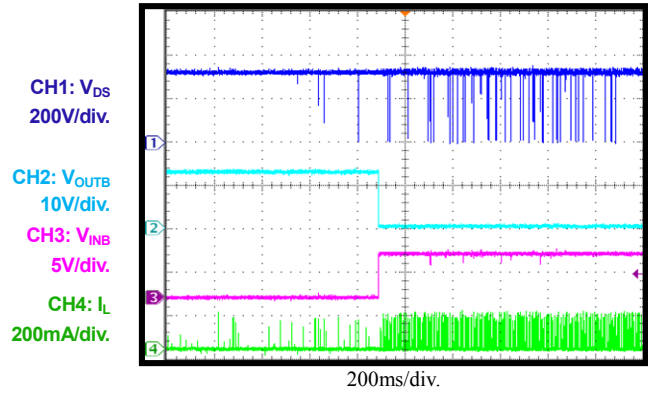

Relay2 Turn-Off

No Load

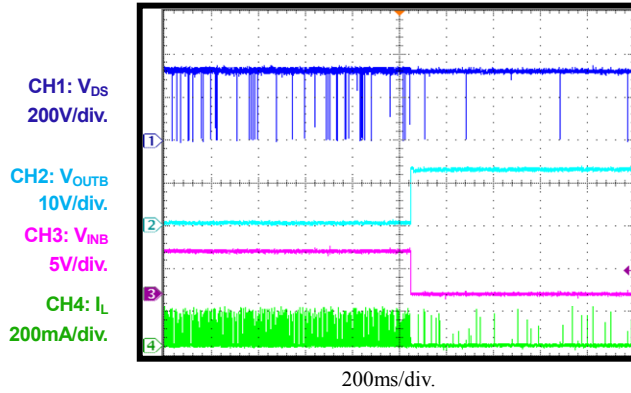

CIRCUIT DESCRIPTION

The EV161-S-00A is configured in a buck regulator topology, it uses primary-side-control which can mostly simplify the schematic and get a cost effective BOM. It can also achieve accurate constant voltage and acceptable cross regulation.

F1 is used to protect circuit from component failure or some excessive short events; also it can restrain the inrush current.

C4, L1 and C5 compose π filter to guarantee the conducted EMI meet standard EN55022. C4 and C5 are also used for energy storage and protecting against line surge.

C2 is VCC capacitor, which is also used as the sample-hold capacitor for output voltage feedback.

D5 is the freewheeling diode. For universal voltage applications, use a diode with a 600V reverse block voltage. Ultra-fast recovery diode is recommended for better efficiency.

C6 and C7 are output capacitors for 12V output. C6 should be low ESR electrolytic capacitor for better output ripple. C7 is ceramic capacitor to reduce high frequency voltage ripple.

C10 is the input capacitor of built in LDO. And C8 is the output capacitor of LDO.

SW1, SW2, SW3 are the self-locking push buttons. They control the logic input of STBY, INA and INB. The logic high is drawn from 5V output of LDO.

SW1 controls the standby function, MP161 will enter standby mode when SW1 is pushed down. MP161 recovers form standby mode when SW1 is released.

SW2 and SW3 control the relay drivers. When SW2 is pushed, relay1 will engage. SW3 works the same way.

QUICK START GUIDE

1. Preset power supply to $85\text{VAC} \leq V_{\text{IN}} \leq 265\text{VAC}$.
2. Turn power supply off.
3. Connect the Line and Neutral terminals of the power supply output to L and N port.
4. Connect different loads to corresponding outputs :
 - a. Positive (+): VOUT1, VOUT2
 - b. Negative (-): GND
5. Turn power supply on after making connections.
6. Push down SW1 to enter Standby Mode. Push SW1 again to release it and exit Standby Mode.
7. Push down SW2 to engage Relay1. Push SW2 again to release it and disengage Relay1.
8. Push down SW3 to engage Relay2. Push SW3 again to release it and disengage Relay2.

Caution:

This EVB is non-isolated. Do not touch anywhere that has electrical connections, because they are all coupled to high voltage potential.

NOTICE: The information in this document is subject to change without notice. Please contact MPS for current specifications. Users should warrant and guarantee that third party Intellectual Property rights are not infringed upon when integrating MPS products into any application. MPS will not assume any legal responsibility for any said applications.

X-ON Electronics

Largest Supplier of Electrical and Electronic Components

Click to view similar products for [Power Management IC Development Tools](#) *category:*

Click to view products by [Monolithic Power Systems](#) *manufacturer:*

Other Similar products are found below :

[EVAL-ADM1168LQEBZ](#) [EVB-EP5348UI](#) [MIC23451-AAAYFL EV](#) [MIC5281YMME EV](#) [DA9063-EVAL](#) [ADP122-3.3-EVALZ](#) [ADP130-0.8-EVALZ](#) [ADP130-1.2-EVALZ](#) [ADP130-1.5-EVALZ](#) [ADP130-1.8-EVALZ](#) [ADP1712-3.3-EVALZ](#) [ADP1714-3.3-EVALZ](#) [ADP1715-3.3-EVALZ](#) [ADP1716-2.5-EVALZ](#) [ADP1740-1.5-EVALZ](#) [ADP1752-1.5-EVALZ](#) [ADP1828LC-EVALZ](#) [ADP1870-0.3-EVALZ](#) [ADP1871-0.6-EVALZ](#) [ADP1873-0.6-EVALZ](#) [ADP1874-0.3-EVALZ](#) [ADP1882-1.0-EVALZ](#) [ADP199CB-EVALZ](#) [ADP2102-1.25-EVALZ](#) [ADP2102-1.875EVALZ](#) [ADP2102-1.8-EVALZ](#) [ADP2102-2-EVALZ](#) [ADP2102-3-EVALZ](#) [ADP2102-4-EVALZ](#) [ADP2106-1.8-EVALZ](#) [ADP2147CB-110EVALZ](#) [AS3606-DB](#) [BQ24010EVM](#) [BQ24075TEVM](#) [BQ24155EVM](#) [BQ24157EVM-697](#) [BQ24160EVM-742](#) [BQ24296MEVM-655](#) [BQ25010EVM](#) [BQ27411EVM-G1A](#) [BQ3055EVM](#) [NCV891330PD50GEVB](#) [ISLUSBI2CKIT1Z](#) [LM2744EVAL](#) [LM2854EVAL](#) [LM3658SD-AEV/NOPB](#) [LM3658SDEV/NOPB](#) [LM3691TL-1.8EV/NOPB](#) [LM4510SDEV/NOPB](#) [LM5033SD-EVAL](#)