



EV2018-ZD-33-00A

16V, 500mA, Low Quiescent Current Line Regulator Evaluation Board

DESCRIPTION

The EV2018-ZD-33-00A is an evaluation board for the MP2018GZD-33, which is a low power linear regulator that supplies power to systems with high voltage batteries. It includes a wide 4.3V to 16V input range, low dropout voltage and low quiescent supply current. The low quiescent current and low dropout voltage allows operations at extremely low power levels. Therefore, the MP2018GZD-33 is ideal for the low power microcontrollers and the battery-powered equipments.

The EV2018-ZD-33-00A is a fully assembled and tested evaluation board. It generates a +3.3V output voltage at load current up to 500mA from 4.3V to 16V input range.

ELECTRICAL SPECIFICATIONS

Parameter	Symbol	Value	Units
Input Voltage	V_{IN}	4.3 – 16	V
Output Voltage	V_{OUT}	3.3	V
Output Current	I_{OUT}	500	mA

FEATURES

- 4.3V to 16V Input Range
- 12 μ A Quiescent Supply Current
- Stable With Low-value Output Ceramic Capacitor (> 0.47 μ F)
- 500mA Specified Current
- Fixed Output Voltage
- Output \pm 2% Accuracy Over Temperature
- Specified Current Limit
- Power Good
- Programmable Power Good Delay
- Thermal Shutdown and Short-Circuit Protection
- -40°C to +125°C Specified Junction Temperature Range
- Available in TO252-5 Package

APPLICATIONS

- Industrial/Automotive Applications
- Portable/Battery-Powered Equipment
- Ultra Low Power Microcontrollers
- Cellular Handsets
- Medical Imaging

All MPS parts are lead-free and adhere to the RoHS directive. For MPS green status, please visit MPS website under Products, Quality Assurance page. "MPS" and "The Future of Analog IC Technology" are registered trademarks of Monolithic Power Systems, Inc.

EV2018-ZD-33-00A EVALUATION BOARD

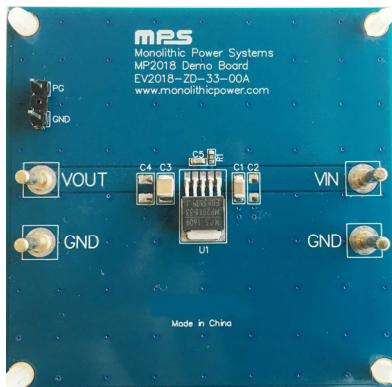

(L x W x H) 6.35cm x 6.35cm x 1.0cm

Board Number	MPS IC Number
EV2018-ZD-33-00A	MP2018GZD-33

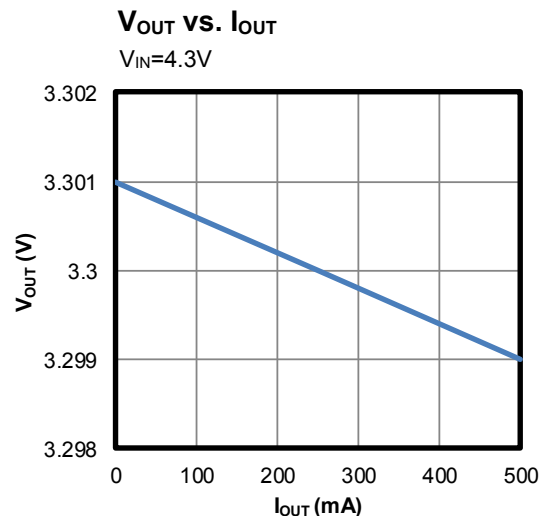

QUICK START GUIDDE

1. Connect the positive and negative terminals of the load to the VOUT and GND pins, respectively. Set load current between 0 – 500mA. Be aware that electronic loads represent a negative impedance to the regulator and if set to a too high current will trigger over-current-protection or short-current-protection.
2. Preset the power supply output between 4.3V and 16V, and then turn it off.
If longer cables are used between the source and the EVB (>0.5m total), a damping capacitor should be installed at the input terminals.
3. Connect the positive and negative terminals of the power supply output to the VIN and GND pins, respectively.
4. Turn the power supply on. The MP2018GZD-33 will automatically startup. The default VOUT is 3.3V.
5. Setting PGDL

There is a delay time when PG asserts high, the delay time can be programmed by adding a capacitor on PGDL. To select a capacitor for PGDL, use below equation:

$$C_{PGDL} \text{ (nF)} = \frac{t_{PGDL} \text{ (ms)} \times I_{PGDL} \text{ (\mu A)}}{V_{th_PGDL} \text{ (V)}}$$

The t_{PGDL} is the desired delay time for PG asserts high, I_{PGDL} is the PGDL charging current (5.5 μ A) and V_{th_PGDL} is 1.65V.

EVALUTION BOARD SCHEMATIC

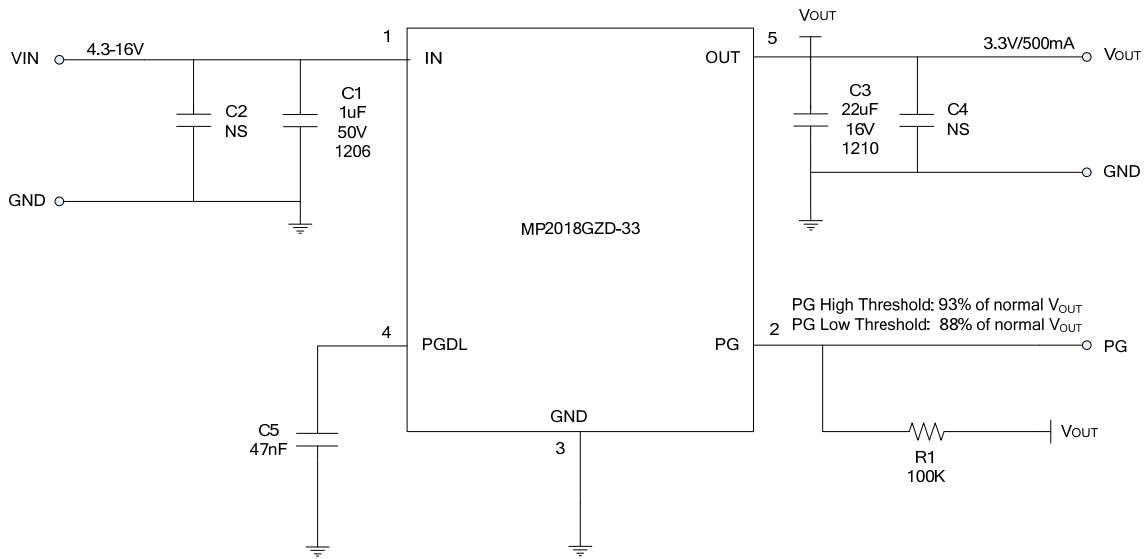

MP2018GZD-33

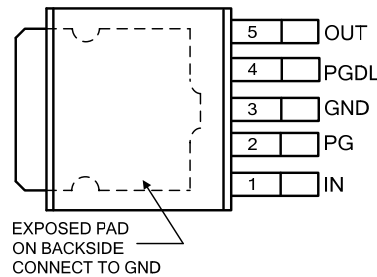

TO252-5

Reference for C_{PGDL} (C5) Selection

C5(nF)	T _{PGDL} (ms)
Floating	0.044
1	0.35
10	3.11
22	6.58
47	14.54
100	30.5

EV2018-ZD-33-00A BILL OF MATERIALS

Qty	RefDes	Value	Description	Package	Manufacturer	Manufacturer_P/N
1	C1	1 μ F	Ceramic Cap, 50V, X7R	1206	Murata	GRM31CR71H225KA88L
2	C2,C4	NS				
1	C3	22 μ F	Ceramic Cap, 16V, X7R	1210	Murata	GRM32ER71C226KEA8L
1	C5	47nF	Ceramic Cap, 50V, X7R	0603	Murata	GRM188R71H473KA61D
1	R1	100k	Film Res,1%	0603	Yageo	RC0603FR-07100KL
1	U1		Linear Regulator	TO252-5	MPS	MP2018GZD-33
4	VIN,GND, GND, VOUT		2.0 Golden Pin		Any	
2	PG,GND		2.54mm Test Pin		Any	

EVB TEST RESULTS

Performance waveforms are tested on the evaluation board.

$C_{IN} = 1\mu F$, $C_{OUT} = 22\mu F$, $V_{OUT} = 3.3V$, $T_A = 25^\circ C$, unless otherwise noted.

Dropout Voltage vs. Load Current

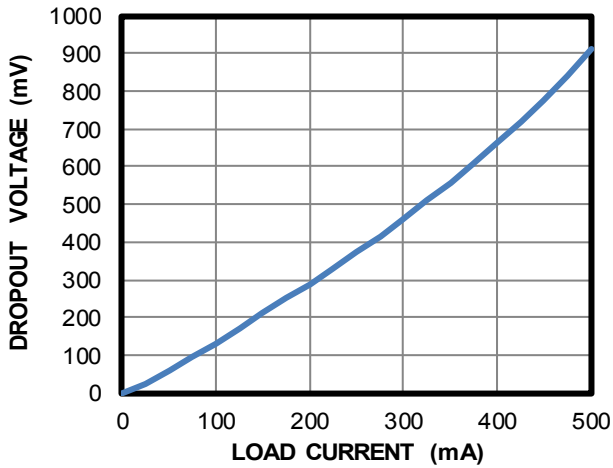

V_{OUT} vs. I_{OUT}
 $V_{IN}=4.3V$

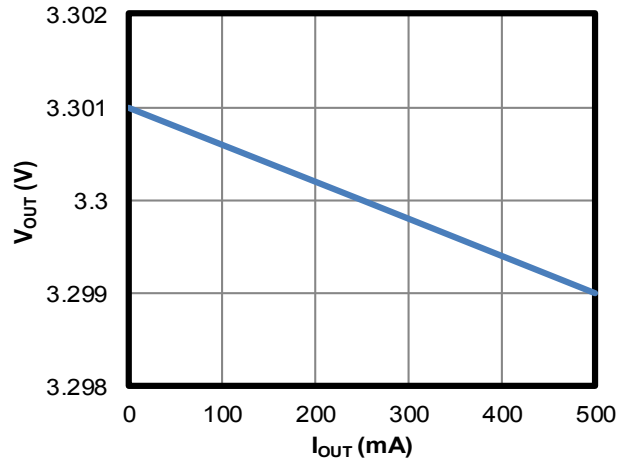

V_{OUT} vs. V_{IN}

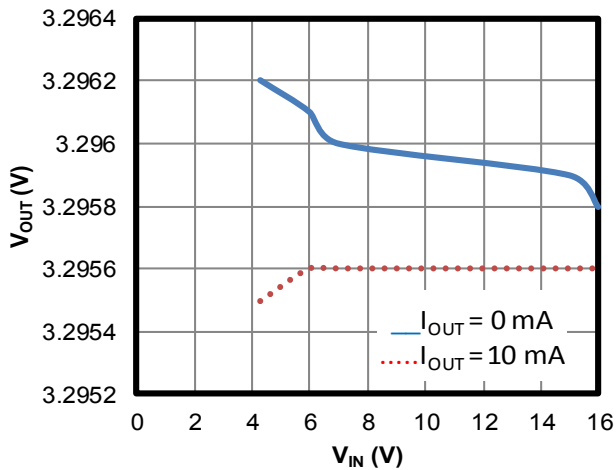

PSRR vs. Frequency

$C_{IN}=100pF$, $C_{OUT}=10\mu F$, $I_{OUT}=10mA$

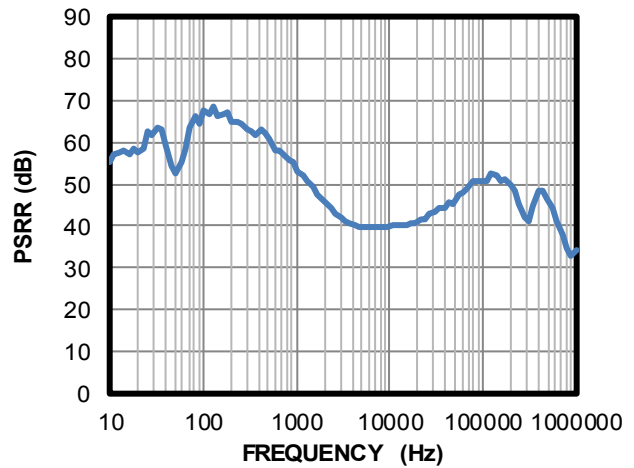

EVB TEST RESULTS (continued)

Performance waveforms are tested on the evaluation board.

$C_{IN} = 1\mu F$, $C_{OUT} = 22\mu F$, $V_{OUT} = 3.3V$, $T_A = 25^\circ C$, unless otherwise noted.

Load Transient

$V_{IN}=12V$, $I_{OUT}=0 \rightarrow 500mA$

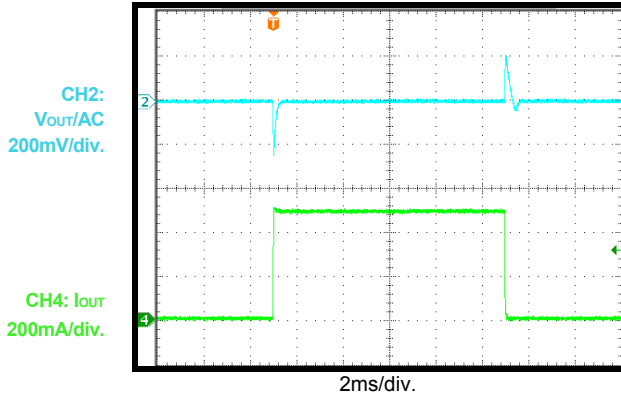

Line Transient

$V_{IN}=4.3V-5.3V$, $I_{OUT}=500mA$

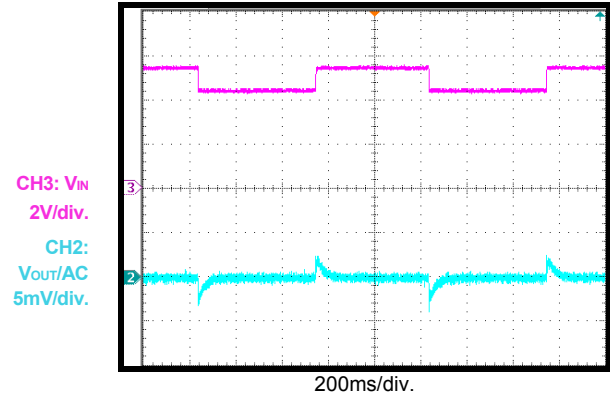

Start-Up Through V_{IN}

$V_{IN}=12V$, $I_{OUT}=500mA$

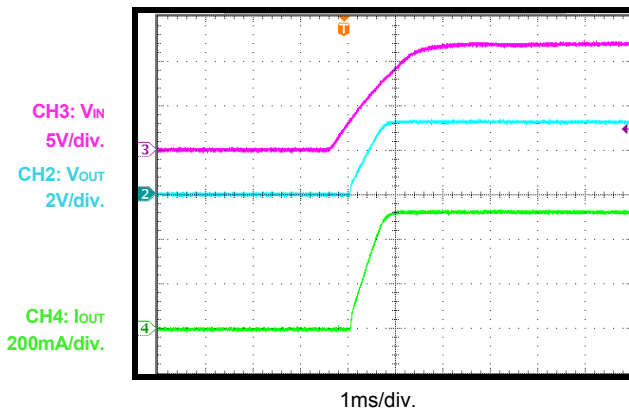

Shutdown Through V_{IN}

$V_{IN}=12V$, $I_{OUT}=500mA$

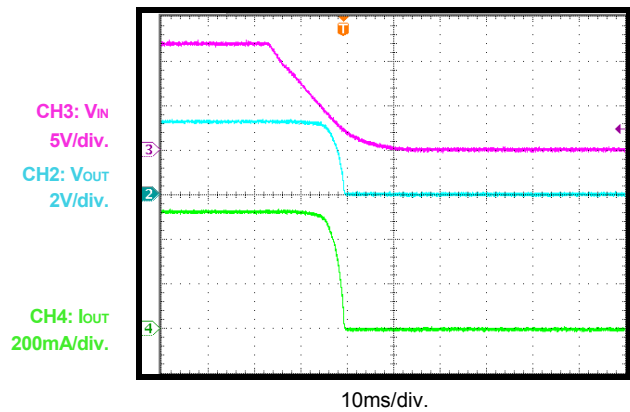

Short-Circuit Entry

$I_{OUT}=0mA$ to Short Circuit

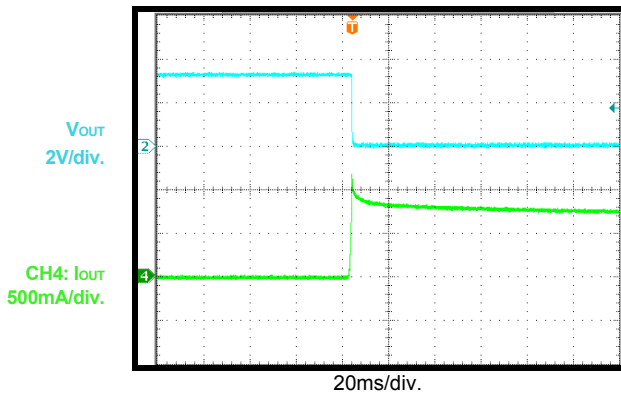

Short-Circuit Recovery

$V_{IN} = 12V$, Short Circuit to $I_{OUT}=0mA$

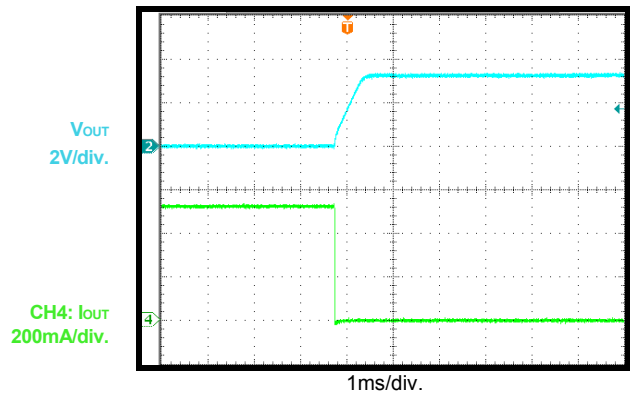

EVB TEST RESULTS *(continued)*

Performance waveforms are tested on the evaluation board.

$C_{IN} = 1\mu F$, $C_{OUT} = 22\mu F$, $V_{OUT} = 3.3V$, $T_A = 25^\circ C$, unless otherwise noted.

Short-Circuit Steady State

$V_{IN} = 12V$

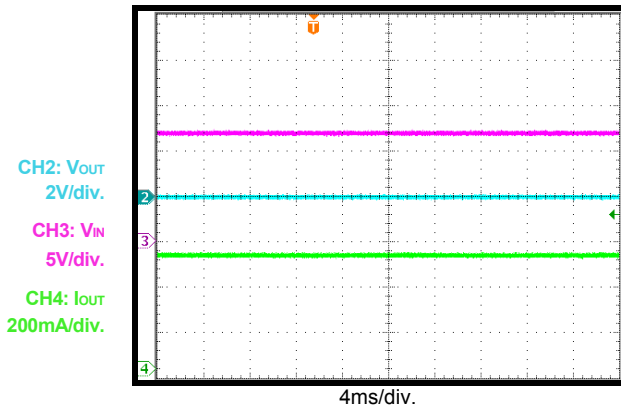

PRINTED CIRCUIT BOARD LAYOUT

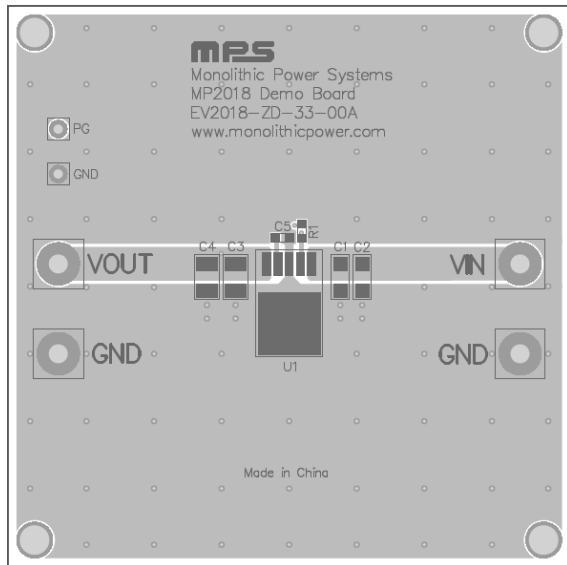

Figure 1: Top Silk & Top Layer

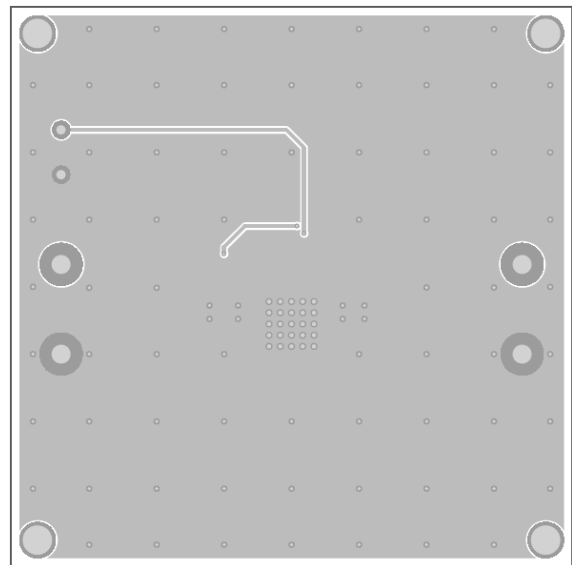

Figure 2: Bottom Layer

NOTICE: The information in this document is subject to change without notice. Please contact MPS for current specifications. Users should warrant and guarantee that third party Intellectual Property rights are not infringed upon when integrating MPS products into any application. MPS will not assume any legal responsibility for any said applications.

X-ON Electronics

Largest Supplier of Electrical and Electronic Components

Click to view similar products for [Power Management IC Development Tools](#) *category:*

Click to view products by [Monolithic Power Systems](#) *manufacturer:*

Other Similar products are found below :

[EVAL-ADM1168LQEBZ](#) [EVB-EP5348UI](#) [MIC23451-AAAYFL EV](#) [MIC5281YMME EV](#) [DA9063-EVAL](#) [ADP122-3.3-EVALZ](#) [ADP130-0.8-EVALZ](#) [ADP130-1.2-EVALZ](#) [ADP130-1.5-EVALZ](#) [ADP130-1.8-EVALZ](#) [ADP1712-3.3-EVALZ](#) [ADP1714-3.3-EVALZ](#) [ADP1715-3.3-EVALZ](#) [ADP1716-2.5-EVALZ](#) [ADP1740-1.5-EVALZ](#) [ADP1752-1.5-EVALZ](#) [ADP1828LC-EVALZ](#) [ADP1870-0.3-EVALZ](#) [ADP1871-0.6-EVALZ](#) [ADP1873-0.6-EVALZ](#) [ADP1874-0.3-EVALZ](#) [ADP1882-1.0-EVALZ](#) [ADP199CB-EVALZ](#) [ADP2102-1.25-EVALZ](#) [ADP2102-1.875EVALZ](#) [ADP2102-1.8-EVALZ](#) [ADP2102-2-EVALZ](#) [ADP2102-3-EVALZ](#) [ADP2102-4-EVALZ](#) [ADP2106-1.8-EVALZ](#) [ADP2147CB-110EVALZ](#) [AS3606-DB](#) [BQ24010EVM](#) [BQ24075TEVM](#) [BQ24155EVM](#) [BQ24157EVM-697](#) [BQ24160EVM-742](#) [BQ24296MEVM-655](#) [BQ25010EVM](#) [BQ3055EVM](#) [NCV891330PD50GEVB](#) [ISLUSBI2CKIT1Z](#) [LM2744EVAL](#) [LM2854EVAL](#) [LM3658SD-AEV/NOPB](#) [LM3658SDEV/NOPB](#) [LM3691TL-1.8EV/NOPB](#) [LM4510SDEV/NOPB](#) [LM5033SD-EVAL](#) [LP38512TS-1.8EV](#)