



EVQ3362-J-00A

Single-String, 3V V_{IN-MIN} , 36V V_{OUT} Boost LED Driver Evaluation Board, AEC-Q100

DESCRIPTION

The EVQ3362-J-00A is designed for the MPQ3362, a boost LED driver that is well-suited for low-to-high current boost applications. The device's low 0.2V feedback voltage offers higher efficiency in white LED driver applications.

The MPQ3362 regulates the output voltage up to 36V, with up to 95% efficiency. Current mode regulation and external compensation components allow the MPQ3362 control loop to be optimized across a wide input voltage range.

The MPQ3362 supports analog dimming and PWM dimming on the same pin (the EN/DIM pin). A <2kHz input dimming frequency initiates PWM dimming, while a >5kHz input dimming frequency initiates analog dimming.

Soft start, cycle-by-cycle current limiting, and V_{IN} under-voltage lockout (UVLO) prevent the device from overstress or damage. This protects the sensitive external circuitry during start-up, and under overload conditions.

The MPQ3362 is available in a TSOT23-8 package.

ELECTRICAL SPECIFICATIONS

Parameter	Symbol	Value	Units
Input voltage	V_{IN}	3 to 36	V
Output voltage	V_{OUT}	<40	V
LED string	-	1	string
LED current	I_{LED}	200	mA

FEATURES

- 3V to 36V Input Voltage Range
- 4A Peak Current Limit
- 0.3 μ A Shutdown Current
- Low 200mV Feedback Voltage
- Configurable 200kHz to 2.2MHz Switching Frequency
- Internal 80m Ω , 40V Power Switch
- High Efficiency
- Analog and PWM Dimming
- Under-Voltage Lockout (UVLO)
- Open/Short LED Protection
- Short FB Protection
- Soft Start
- Thermal Shutdown
- Available in a TSOT23-8 Package
- AEC-Q100 Grade 1

APPLICATIONS

- Automotive Display Backlighting
- Medium-Sized LCD Backlighting
- General Lighting

All MPS parts are lead-free, halogen-free, and adhere to the RoHS directive. For MPS green status, please visit the MPS website under Quality Assurance. "MPS", the MPS logo, and "Simple, Easy Solutions" are registered trademarks of Monolithic Power Systems, Inc. or its subsidiaries.



EVQ3362-J-00A EVALUATION BOARD



LxWxH (6.35cmx6.35cmx1.0cm)

Board Number	MPS IC Number
EVQ3362-J-00A	MPQ3362GJ



QUICK START GUIDE

1. Preset the DC power supply to be between 2.5V to 36V, then turn the power supply off.
2. Connect the power supply output terminals to:
 - a. Positive (+): VIN
 - b. Negative (-): GND
3. Connect the LED load between the anode of the LED string (LED+) and the cathode of the LED string (LED-).
4. Turn the power supply on.
5. To turn on the chip, apply a voltage to the EN/DIM pin to pull the pin high. For dimming, apply a PWM signal to the EN/DIM pin. Analog dimming requires a PWM frequency (f_{PWM}) above 5kHz. For PWM dimming, f_{PWM} must be below 2kHz.

EVALUATION BOARD SCHEMATIC

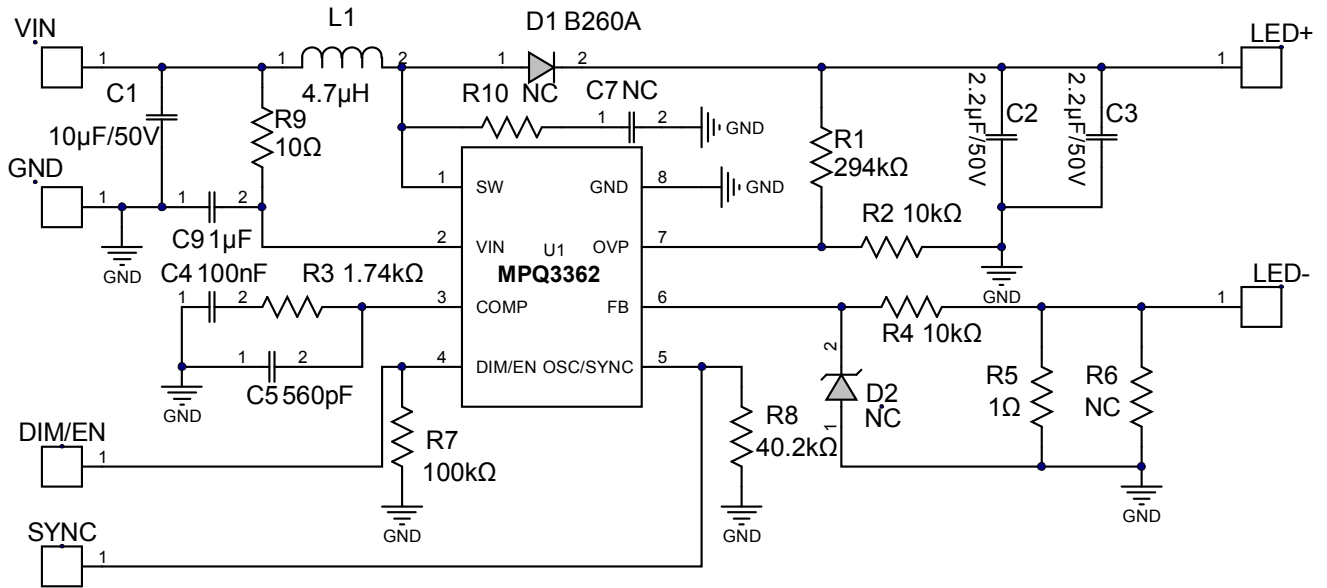

Figure 1: Evaluation Board Schematic

EVQ3362-J-00A BILL OF MATERIALS

Qty	Ref	Value	Description	Package	Manufacturer	Manufacturer P/N
1	C1	10 μ F	Ceramic capacitor, 50V, X7R, 1210	1210	TDK	C3225X7R1H106M
2	C2, C3	2.2 μ F	Ceramic capacitor, 50V, X7R, 1210	1210	Murata	GJ8319R61H225K
1	C4	100nF	Ceramic capacitor, 25V, X7R, 0603	0603	Wurth	885012206071
1	C5	560pF	Ceramic capacitor, 50V, X7R, 0603	0603	Murata	GRM1885C1H561JA01
1	C7	NC				
1	C9	1 μ F	Ceramic capacitor, 50V, X7R, 0805	0805	Murata	GRM21BR71H105KA12 L
1	D1	B260A	60V/2A	SMA	Diodes	B260A-13-F
1	D2	NC				
1	L1	4.7 μ H	Inductor, 4.7 μ H, 9.5m Ω , 6.7A	SMD	Cooper	DR1050-4R7
1	R1	294k Ω	Film resistor, 1%	0603	Yageo	RC0603FR-07294KL
2	R2, R4	10k Ω	Film resistor, 1%	0603	Yageo	RC0603FR-0710KL
1	R3	1.74k Ω	Film resistor, 1%	0603	Yageo	RC0603FR-071K74RL
1	R5	1 Ω	Film resistor, 1%	0603	Yageo	RC0603FR-07100KL
2	R6, R10	NC				
1	R7	100k Ω	Film resistor, 1%	0603	Yageo	RC0603FR-07100KL
1	R8	40.2k Ω	Film resistor, 1%	0603	Yageo	RC0603FR-0740K2L
1	R9	10 Ω	Film resistor, 5%	0603	Yageo	RC0603JR-0710RL
6	VIN, GND, LED+, LED-, DIM/EN, SYNC	2.54mm	Connector, 2.54mm 180 degree pin header	CONN/TP	Any	
1	U1	MPQ3362	Single-string boost LED driver	TSOT23-8	MPS	MPQ3362GJ

EVB TEST RESULTS

Performance waveforms are tested on the evaluation board. $V_{IN} = 10V$, Load: 10 LEDs, $I_{LED} = 200mA$, $L = 4.7\mu H$, $T_A = 25^\circ C$, unless otherwise noted

Steady State

$V_{IN} = 3V$, Load: 3 LEDs

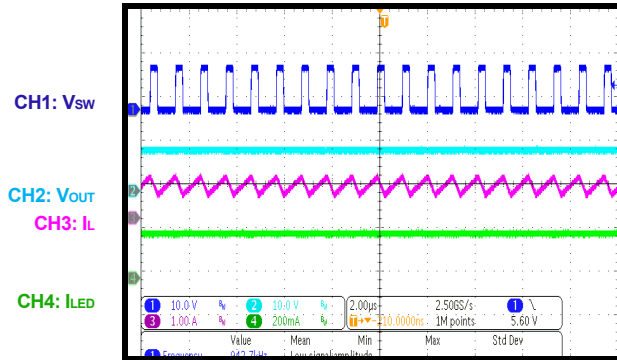

Steady State

$V_{IN} = 10V$, Load: 10 LEDs

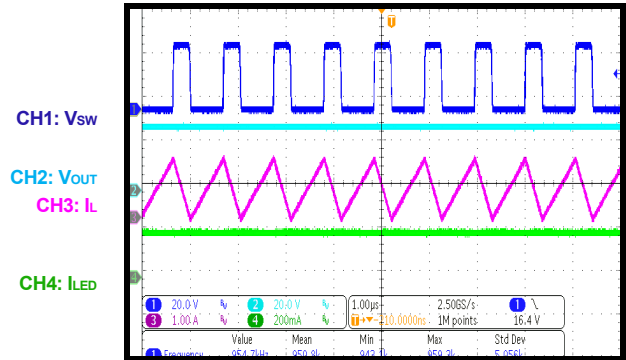

Shutdown through VIN

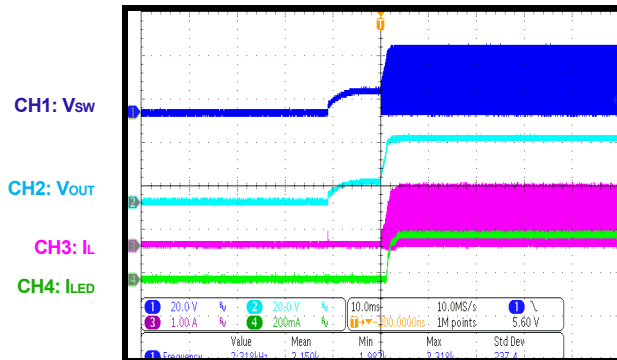

Shutdown through VIN

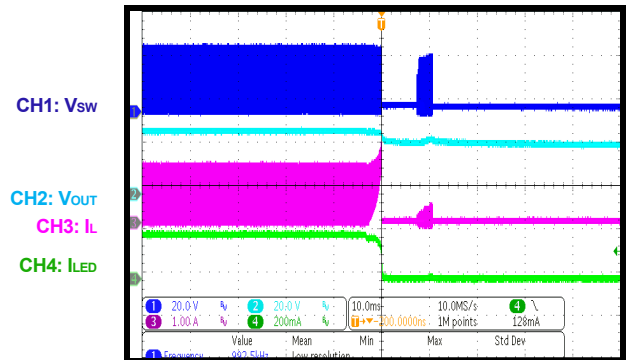

Start-Up through EN/DIM

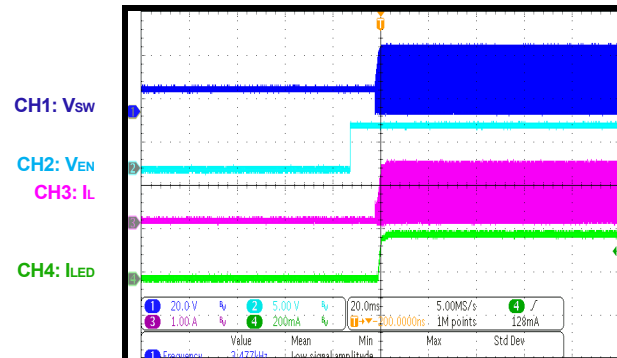

Shutdown through EN/DIM

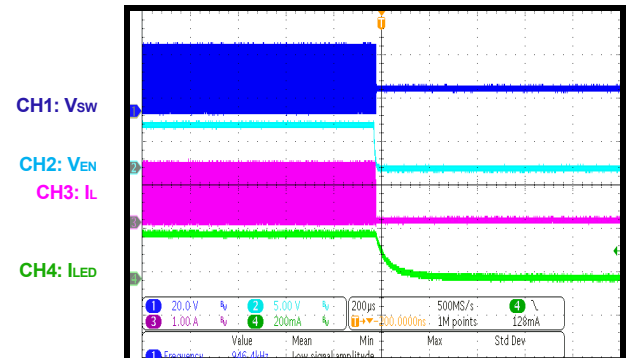

TYPICAL PERFORMANCE CHARACTERISTICS *(continued)*

$V_{IN} = 10V$, Load: 10 LEDs, $I_{LED} = 200mA$, $L = 4.7\mu H$, $T_A = 25^\circ C$, unless otherwise noted

PWM Power On
 $f_{PWM} = 10kHz$ ($D = 0.5$)

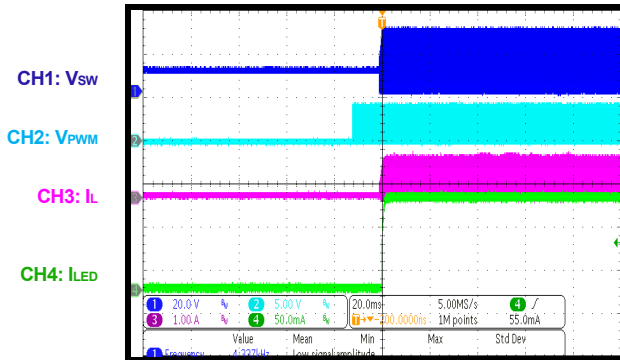

PWM Power Off
 $f_{PWM} = 10kHz$ ($D = 0.5$)

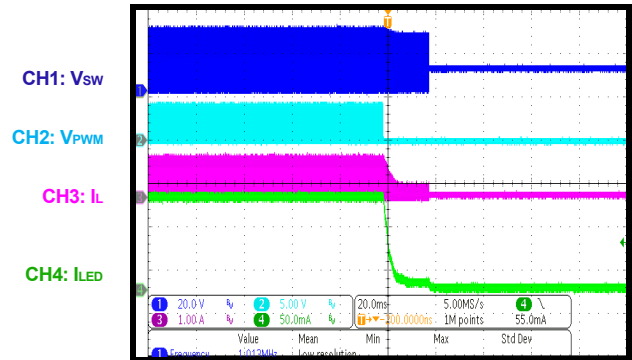

PWM Dimming
 $f_{PWM} = 200Hz$ ($D = 0.5$)

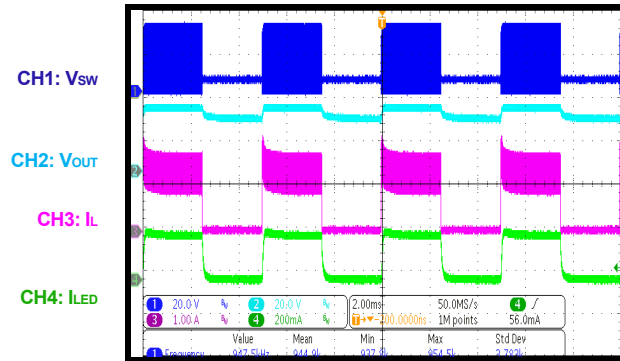

PWM Dimming
 $f_{PWM} = 2kHz$ ($D = 0.5$)

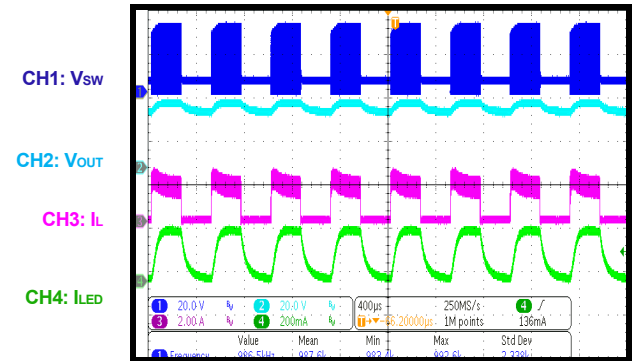

Analog Dimming
 $f_{PWM} = 5kHz$ ($D = 0.5$)

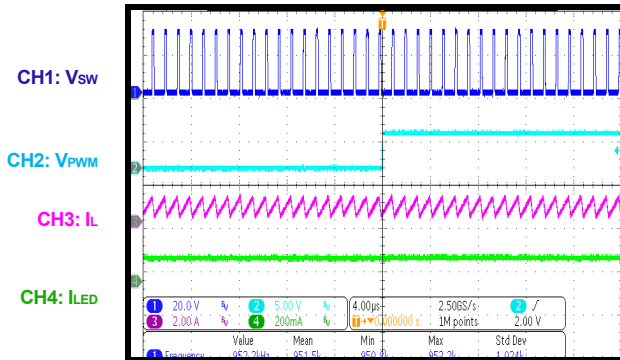

OVP during Normal Operation

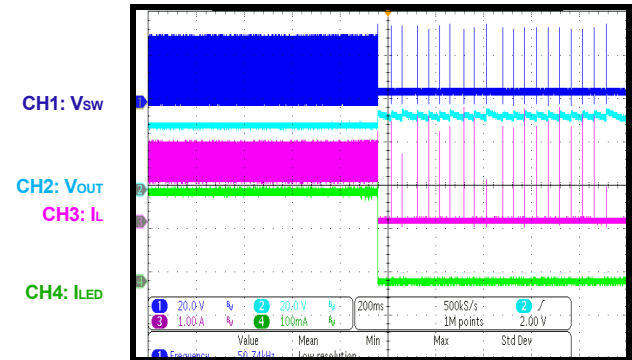

TYPICAL PERFORMANCE CHARACTERISTICS (continued)

$V_{IN} = 10V$, Load: 10 LEDs, $I_{LED} = 200mA$, $L = 4.7\mu H$, $T_A = 25^\circ C$, unless otherwise noted

Inductor Short during Normal Operation and Recovery

Load: 5 LEDs

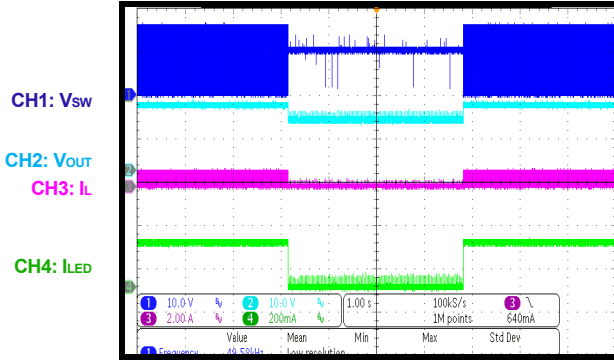

PCB LAYOUT

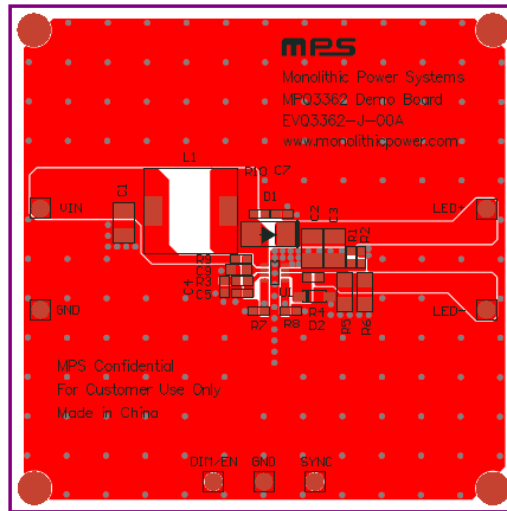

Figure 2: Top Layer

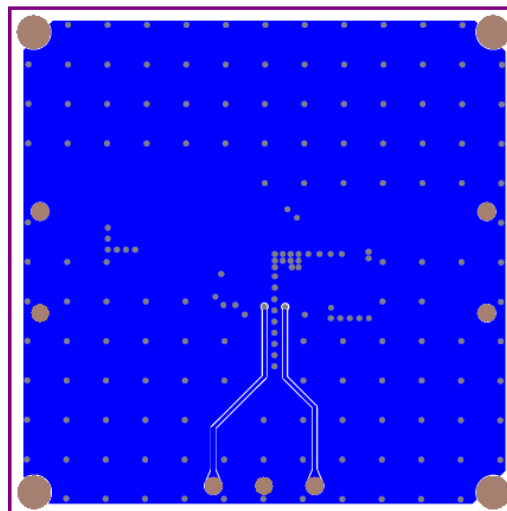

Figure 3: Bottom Layer



REVISION HISTORY

Revision #	Revision Date	Description	Pages Updated
1.0	04/08/2020	Initial Release	-
1.1	05/24/2021	Technical edit	All pages

Notice: The information in this document is subject to change without notice. Users should warrant and guarantee that third-party Intellectual Property rights are not infringed upon when integrating MPS products into any application. MPS will not assume any legal responsibility for any said applications.

X-ON Electronics

Largest Supplier of Electrical and Electronic Components

Click to view similar products for [LED Lighting Development Tools](#) category:

Click to view products by [Monolithic Power Systems](#) manufacturer:

Other Similar products are found below :

[MIC2870YFT EV](#) [ADP8860DBCP-EVALZ](#) [LM3404MREVAL](#) [ADM8843EB-EVALZ](#) [TDGL014](#) [ISL97682IRTZEVALZ](#) [LM3508TLEV](#)
[EA6358NH](#) [MAX16826EVKIT](#) [MAX16839EVKIT+](#) [TPS92315EVM-516](#) [MAX1698EVKIT](#) [MAX6956EVKIT+](#) [OM13321,598](#) [DC986A](#)
[DC909A](#) [DC824A](#) [STEVAL-LLL006V1](#) [IS31LT3948-GRLS4-EB](#) [104PW03F](#) [PIM526](#) [PIM527](#) [MAX6946EVKIT+](#) [MAX20070EVKIT#](#)
[MAX21610EVKIT#](#) [MAX20090BEVKIT#](#) [MAX20092EVSYS#](#) [PIM498](#) [AP8800EV1](#) [ZXLD1370/1EV4](#) [MAX6964EVKIT](#)
[MAX25240EVKIT#](#) [MAX25500TEVKITC#](#) [MAX77961BEVKIT06#](#) [TLC59116EVM-390](#) [1216.1013](#) [TPS61176EVM-566](#) [TPS61197EVM](#)
[TPS92001EVM-628](#) [1270](#) [1271.2004](#) [1272.1030](#) [1273.1010](#) [1278.1010](#) [1279.1002](#) [1279.1001](#) [1282.1000](#) [1293.1900](#) [1293.1800](#) [1293.1700](#)