

### DESCRIPTION

The MA782 detects the absolute angular position of a permanent magnet, such as a diametrically magnetized cylinder on a rotating shaft. With its power cycling ability, the MA782 can be optimized for applications that require low average power. The timing can be controlled by an on-chip clock or via an external controller. Flags can detect a definable amount of angle change.

The device supports a wide range of magnetic field strengths and spatial configurations. Both end-of-shaft and off-axis (side-shaft mounting) configurations are supported.

The MA782 features magnetic field strength detection with configurable thresholds to sense the magnet position relative to the sensor for certain functions (e.g. sensing the axial movements or for diagnostics).

On-chip non-volatile memory (NVM) stores configuration parameters, including the reference zero angle position, the power cycling parameters, the filter window affecting the output resolution, and magnetic field detection thresholds.

The MA782 is available in a QFN-14 (2mmx2mm) package

### FEATURES

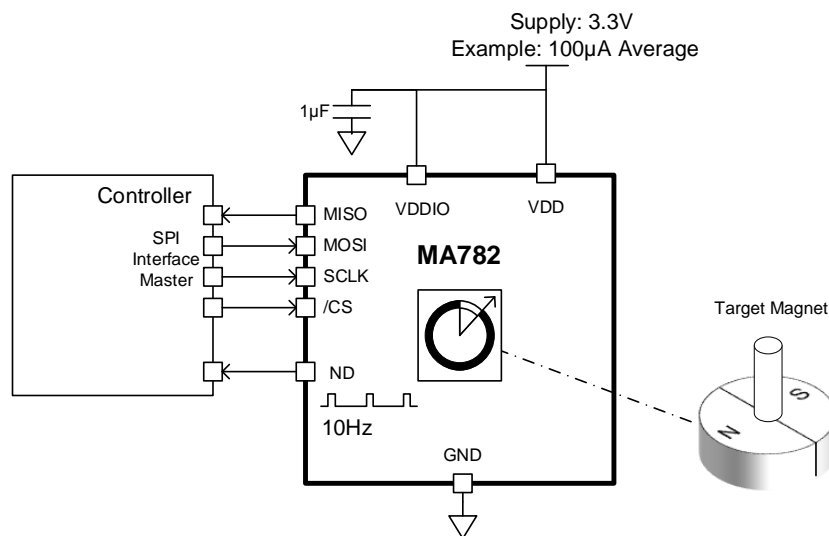
- 8-Bit to 12-Bit Resolution Absolute Contactless Angle Encoder
- <math>0.5\mu\text{A}</math> Current Consumption in Idle Mode
- 10mA Current Consumption in Active Mode
- Angle Detection Interrupt to Wake the System
- Magnetic Field Strength Alarm
- Supports On-Axis and Off-Axis Operation
- Serial Peripheral Interface (SPI)
- 3.3V Supply
- -40°C to +125°C Operating Temperature
- Available in a QFN-14 (2mmx2mm) Package

### APPLICATIONS

- Portable Devices
- Tablet Foldable Displays
- Mobile Flip Phones
- E-Bike Shifters and Throttle Control
- Smart Door Locks
- Low-Power Rotary HMI Dials or Push-Buttons

All MPS parts are lead-free, halogen-free, and adhere to the RoHS directive. For MPS green status, please visit the MPS website under Quality Assurance. "MPS", the MPS logo, and "Simple, Easy Solutions" are trademarks of Monolithic Power Systems, Inc. or its subsidiaries.

### TYPICAL APPLICATION



### ORDERING INFORMATION

Part Number	Package	Top Marking	MSL Rating
MA782GGU*	QFN-14 (2mmx2mm)	See Below	1

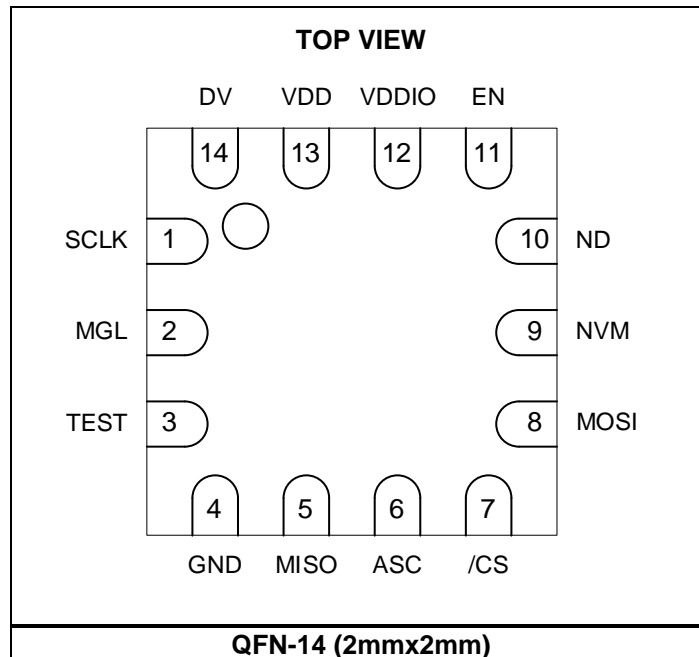
\* For Tape & Reel, add suffix -Z (e.g. MA782GGU-Z).

### TOP MARKING

**KVY**  
**LLL**

KV: Product code of MA782GGU  
 Y: Year code  
 LLL: Lot number

### PACKAGE REFERENCE



## PIN FUNCTIONS

Pin #	Name	Description
1	SCLK	<b>Clock (SPI).</b> Input.
2	MGL	<b>Digital output indicating if the field strength drops below the MGLT level.</b>
3	TEST	<b>Connect to ground.</b>
4	GND	<b>Supply ground.</b>
5	MISO	<b>Data out (SPI).</b> Output.
6	ASC	<b>Automatic sampling cycle.</b> Input. Connect to GND if not used.
7	/CS	<b>Chip selection (SPI).</b> Input.
8	MOSI	<b>Data in (SPI).</b> Input.
9	NVM	<b>Non-volatile memory (NVM).</b> Output. Indicates when the chip is busy accessing the non-volatile memory (NVM).
10	ND	<b>New data.</b> Output. In ASC mode, ND indicates when new data is ready to be read, or if the displacement exceeds the defined threshold.
11	EN	<b>Enable.</b> Input. Switches the sensor to active mode. Connect EN to GND if it is not used.
12	VDDIO	<b>Supply for the IO (1.8V to 3.3V).</b> VDDIO allows for SPI communication at voltages between 1.8V and 3.3V
13	VDD	<b>Supply 3.3V.</b>
14	DV	<b>Data valid.</b> Output. When active, the DV pin indicates that the digital filter has stabilized.

### ABSOLUTE MAXIMUM RATINGS <sup>(1)</sup>

Supply voltage .....	-0.5V to +4.6V
Input pin voltage (V <sub>IN</sub> ) .....	-0.5V to +6.0V
Output pin voltage (V <sub>OUT</sub> ) .....	-0.5V to +4.6V
Continuous power dissipation (T <sub>A</sub> = 25°C) <sup>(2)</sup>	2.0W
Junction temperature .....	160°C
Lead temperature .....	260°C
Storage temperature.....	-65°C to +150°C

### ESD Ratings

Human body model (HBM) .....	±2kV
Charged device model (CDM).....	±2kV

### Recommended Operating Conditions

Supply voltage (V <sub>DD</sub> ).....	3.0V to 3.6V
I/O supply voltage (V <sub>DDIO</sub> ).....	1.8V to 3.6V
Operating temperature (T <sub>OP</sub> )....	-40°C to +125°C
Applied magnetic field (B).....	more than 30mT

### Thermal Resistance <sup>(3)</sup>    $\theta_{JA}$    $\theta_{JC}$

QFN-14 (2mmx2mm).....	90..... 20... °C/W
-----------------------	--------------------

#### Notes:

- 1) Exceeding these ratings may damage the device.
- 2) The maximum allowable power dissipation is a function of the maximum junction temperature, T<sub>J</sub> (MAX), the junction-to-ambient thermal resistance,  $\theta_{JA}$ , and the ambient temperature, T<sub>A</sub>. The maximum allowable continuous power dissipation at any ambient temperature is calculated by P<sub>D</sub> (MAX) = (T<sub>J</sub> (MAX) - T<sub>A</sub>) /  $\theta_{JA}$ .
- 3) Measured on JE51-7, 4-layer PCB.

## ELECTRICAL CHARACTERISTICS

V<sub>DD</sub> = 3.3V, 45mT < B < 100mT, T<sub>A</sub> = -40°C to +125°C, unless otherwise noted.

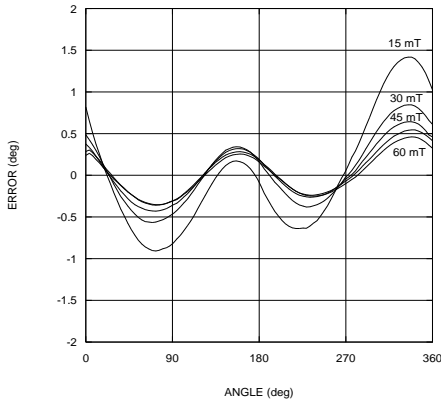
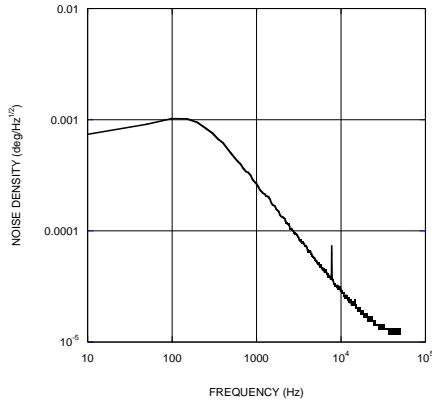
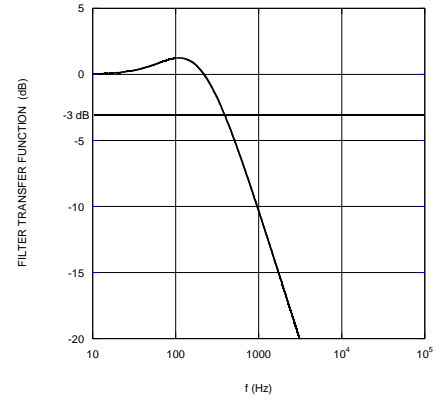
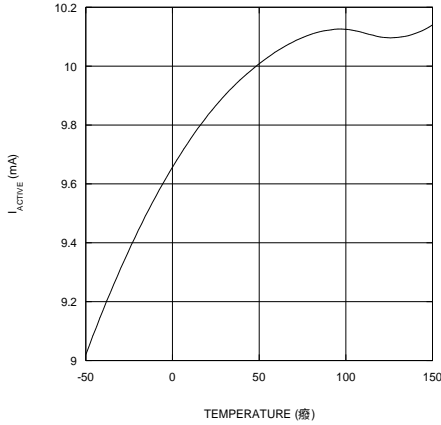
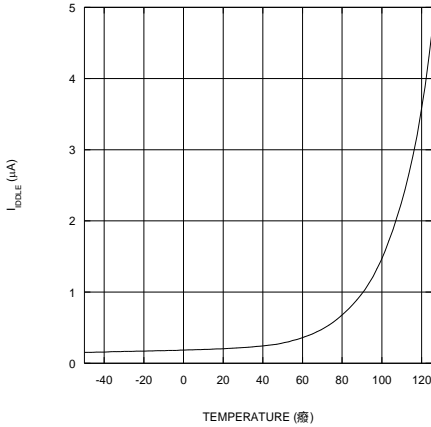
Parameter	Symbol	Condition	Min	Typ	Max	Units
<b>Recommended Operating Conditions</b>						
Supply voltage	V <sub>DD</sub>		3.0	3.3	3.6	V
I/O supply voltage	V <sub>DDIO</sub>		1.8		3.6	V
Operating temperature	T <sub>A</sub>		-40		+125	°C
Applied magnetic field	B		30	60		mT
<b>Supply Current</b>						
Supply current when active	I <sub>ACTIVE</sub>			10		mA
Supply current when idle	I <sub>IDLE</sub>	Below 85°C		1		µA
<b>Absolute Output (Serial)</b>						
Effective resolution		±3σ deviation of the noise distribution	8		12	bit
Noise RMS		1σ of the noise distribution	0.015		0.2	deg
Refresh rate		Active mode	850	980	1100	kHz
Data output length			16		16	bit
<b>Response Time</b>						
V <sub>DD</sub> power-up time		After setting V <sub>DD</sub> at 3.3V		600		µs
Start-up time	t <sub>START_UP</sub>	From active to data valid when FW = 0		35		µs
Latency <sup>(4)</sup>		Constant speed propagation delay when active. The latency is equal to the filter time constant (τ) + 3µs	4		16000	µs
Filter cutoff frequency <sup>(4)</sup>	f <sub>CUTOFF</sub>	Depends on the filter window (FW)	5		160000	Hz
128MHz internal high frequency CLK error (affects all timings)		At room temperature	-13		+12	%
TCYC error		At room temperature	-15		+15	%
<b>Accuracy</b>						
INL at 25°C		At room temperature, across the full field range		0.7		deg
INL between -40°C to +125°C <sup>(5)</sup>		Across the full temperature range and field range		1.1		deg
<b>Output Drift</b>						
Temperature induced drift at room temperature <sup>(5)</sup>				0.01		deg/°C
Temperature induced variation <sup>(5)</sup>		From 25°C to 85°C		0.5		deg
		From 25°C to 125°C		0.7		deg
Magnetic field induced <sup>(5)</sup>				0.01		deg/mT
Voltage supply induced <sup>(5)</sup>				0.35		deg/V
<b>Magnetic Field Detection Thresholds</b>						
Accuracy <sup>(5)</sup>				5		mT
Hysteresis <sup>(5)</sup>	MagHys			6		mT
Temperature drift <sup>(5)</sup>				-600		ppm/°C

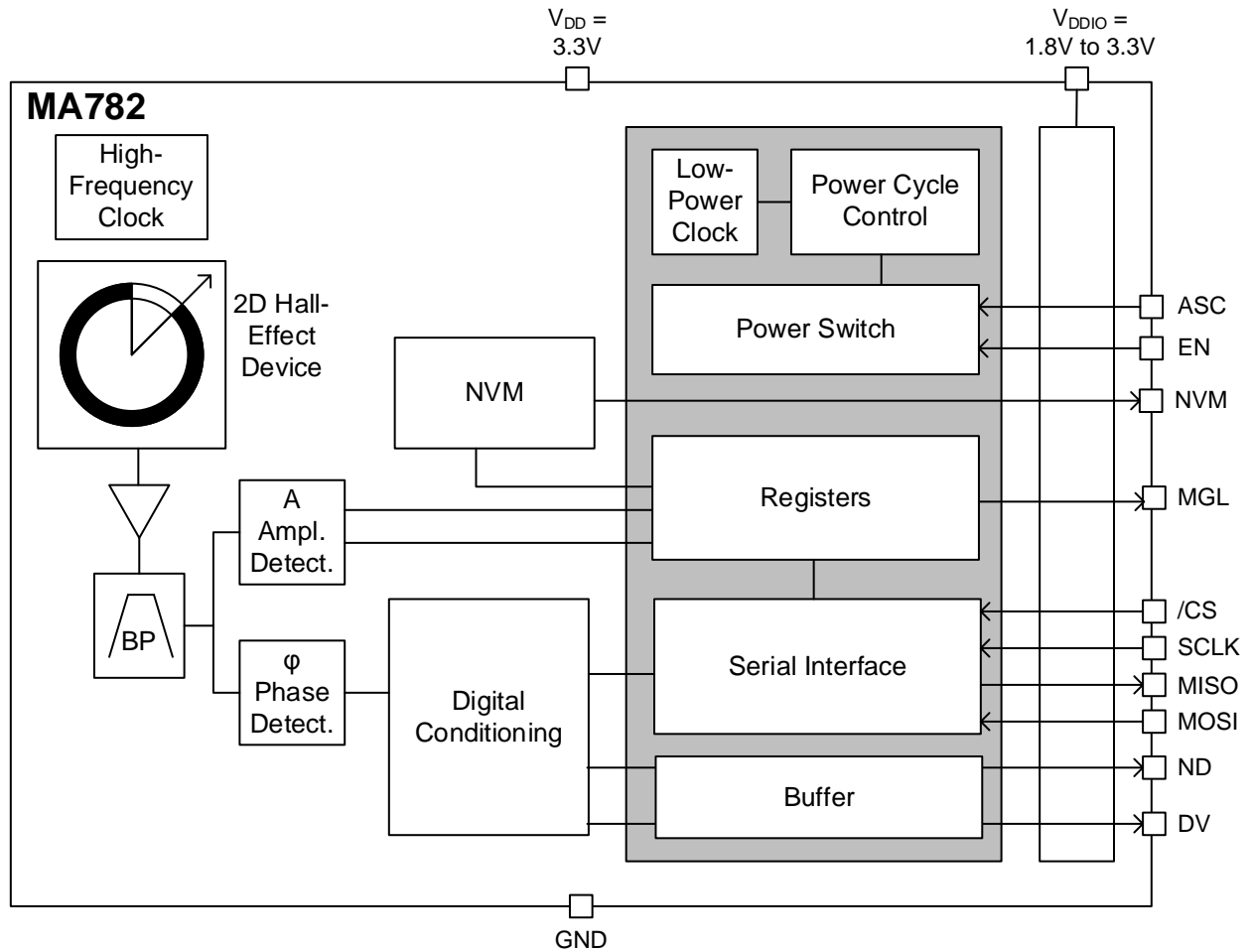
**ELECTRICAL CHARACTERISTICS (continued)**
**VDD = 3.3V, 45mT < B < 100mT, T<sub>A</sub> = -40°C to +125°C, unless otherwise noted.**

Parameter	Symbol	Condition	Min	Typ	Max	Units
<b>Digital I/O</b>						
Input high voltage <sup>(5)</sup>	V <sub>IH</sub>	V <sub>DDIO</sub> = 3.3V	2.5		5.5	V
		V <sub>DDIO</sub> = 1.8V	1.2		5.5	V
Input low voltage <sup>(5)</sup>	V <sub>IL</sub>	V <sub>DDIO</sub> = 3.3V	-0.3		+0.8	V
		V <sub>DDIO</sub> = 1.8V	-0.3		+0.4	V
Output low voltage <sup>(5)</sup>	V <sub>OL</sub>	I <sub>OL</sub> = 4mA, V <sub>DDIO</sub> = 3.3V			0.4	V
		I <sub>OL</sub> = 4mA, V <sub>DDIO</sub> = 1.8V			0.4	V
Output high voltage <sup>(5)</sup>	V <sub>OH</sub>	I <sub>OL</sub> = 4mA, V <sub>DDIO</sub> = 3.3V	2.4			V
		I <sub>OL</sub> = 4mA, V <sub>DDIO</sub> = 1.8V	1.2			V
Falling edge slew rate <sup>(4)</sup>	t <sub>F</sub>	C <sub>L</sub> = 50pF		0.7		V/ns

**Notes:**

- 4) Guaranteed by design.
- 5) Guaranteed by characterization testing.

**TYPICAL CHARACTERISTICS**
**V<sub>DD</sub> = 3.3V, T<sub>A</sub> = 25°C, unless otherwise noted.**
**Error Curves at 25°C**

**Noise Spectrum at 50mT  
FW = 10**

**Filter Transfer Function  
FW = 10**

**Supply Current  
Active mode, V<sub>DD</sub> = 3.3V**

**Supply Current  
Idle mode, V<sub>DD</sub> = 3.3V**


**FUNCTIONAL BLOCK DIAGRAM**

**Figure 1: Functional Block Diagram <sup>(6)</sup>**
**Note:**

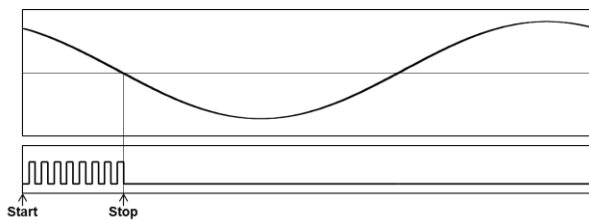
6) Only the gray area operates in idle mode.

## OPERATION

### Sensor Front End

The magnetic field is detected by the integrated Hall devices located in the center of the package. The angle is measured using the Spinaxis™ method, which directly digitizes the direction of the field without complex arctangent computation or feedback loop-based circuits (interpolators).

The Spinaxis™ method is based on phase detection, and this method generates a sinusoidal signal with a phase that represents the angle of the magnetic field. The angle is then obtained by a time-to-digital converter, which measures the time between the zero crossing of the sinusoidal signal and the edge of a constant waveform (see Figure 2). The time-to-digital is output from the front end to the digital conditioning block.



**Top: Sine Waveform**

**Bottom: Clock for Time-to-Digital Converter**

**Figure 2: Phase Detection Method**

The front-end output delivers a digital number that is proportional to the angle of the magnetic field (at the rate of 1MHz) in a straightforward and open-loop manner.

### Digital Filtering

The front-end signal undergoes digital filtering treatment to achieve the final effective resolution. The filter transfer function can be calculated with Equation (1):

$$H(s) = \frac{1}{1+Ts} \quad (1)$$

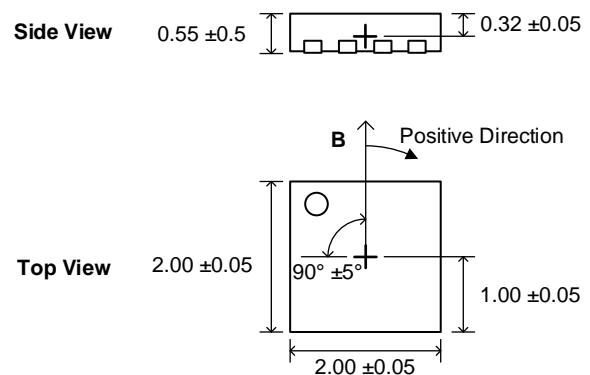
Where  $\tau$  is the filter time constant, which varies depending on the chosen filter window. Table 18 on page 22 shows the  $\tau$  values for different filter window sizes.

To save power, the front end and digital filtering function are disabled in idle mode, but the SPI block works continuously to provide the angle.

### Sensor (Magnet Mounting)

The sensitive volume of the MA782 is confined to a region less than 100 $\mu$ m wide in the center of the package (see Figure 3). This area contains the integrated Hall devices. The sensor detects the angle of the magnetic field projected in a plane parallel to the package's upper surface. This means that the only relevant magnetic field is the in-plane component (X and Y components) in the middle point of the package.

By default, when looking at the top of the package, the angle increases when the magnetic field rotates clockwise. Figure 3 shows the zero angle of a sensor that has not been configured, where the cross indicates the sensitive point and the B arrow is the default zero angle. Both the rotation direction and the zero angle can be configured.



**Figure 3: Sensitive Point and Zero Angle**

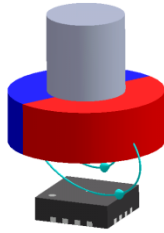
This type of detection provides flexibility for angular encoder design. The sensor requires the magnetic vector to remain within the sensor plane with a field amplitude of at least 30mT. The MA782 can work with fields smaller than 30mT, but the linearity and resolution performance may deviate from the specifications under those conditions.

The most straightforward mounting method is to place the MA782 sensor on the rotation axis of a permanent magnet, such as a diametrically magnetized cylinder (see Figure 4 on page 9).

The recommended magnet is a Neodymium alloy (N35) cylinder with typical dimensions ( $\varnothing$ 5x3mm) inserted into an aluminum shaft, with a 1.5mm air gap between the magnet and the

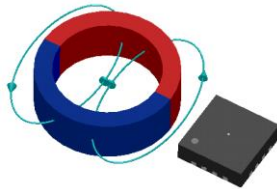


sensor (surface of the package). For optimal linearity, the sensor is positioned with a precision of 0.5mm.



**Figure 4: End-of-Shaft Mounting**

If the end-of-shaft position is not available, the sensor can be positioned away from the rotation axis of a cylinder or ring magnet (see Figure 5). In this case, the magnetic field angle is no longer directly proportional to the mechanical angle. The MA782 can be adjusted to compensate for this effect, and to recover the linear relationship between the mechanical angle and the sensor output. With multiple pole pair magnets, the MA782 indicates multiple rotations for each mechanical turn.



**Figure 5: Side-Shaft Mounting**

### Power Modes

The MA782 has three power modes, described below.

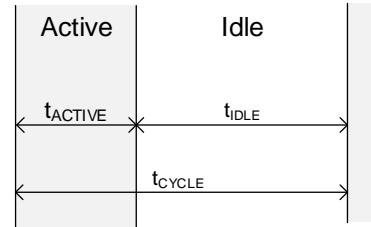
1. **Active:** The sensor runs without interruption, and the current consumption is  $I_{ACTIVE}$  (see the Electrical Characteristics section on page 4).
2. **Idle:** The sensor front end shuts down, and only the SPI communication interface and memory blocks work. The current consumption is  $I_{IDLE}$  (see the Electrical Characteristics section on page 4).
3. **Automatic sampling cycle (ASC):** The device automatically switches between active and idle mode.

Table 1 shows the average supply current ( $I_{AVERAGE}$ ) under different modes.

**Table 1: Supply Current under Different Modes**

Power Mode	Average Supply Current ( $I_{AVERAGE}$ )
Active	$I_{ACTIVE}$
ASC	$I_{IDLE} < I_{AVERAGE} < I_{ACTIVE}$
Idle	$I_{IDLE}$

Figure 6 shows the timing of a power cycle.



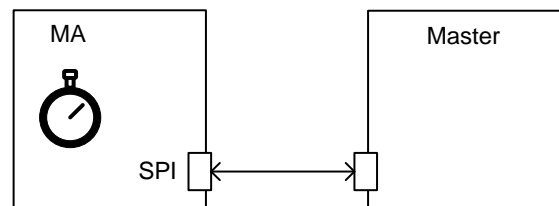
**Figure 6: Timing of a Power Cycle**

By combining these three power modes, the MA782 can be operated in different ways.

### Continuous Automatic Sampling Cycle (ASC)

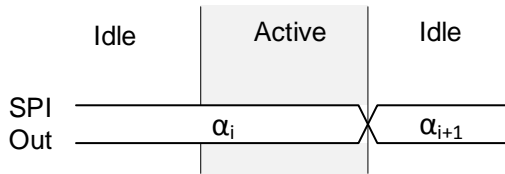
In ASC mode, the on-chip, low-power clock continuously runs to control the sensor's power cycle, according to the active time and cycle time stored in the register.

In the minimum configuration (when ASC mode is set by the internal register), the MA782 only has SPI connections. The master device can communicate with the MA782 at any time, the same way that it does in active mode (see Figure 7). The difference is that in the minimum configuration, the average power consumption is low, and the refresh rate is determined by the TCYC parameter.



**Figure 7: Minimum Configuration for Continuous ASC**

The SPI output updates at the end of the active period (see Figure 8 on page 10).


**Figure 8: Signal Timing for ASC Mode**

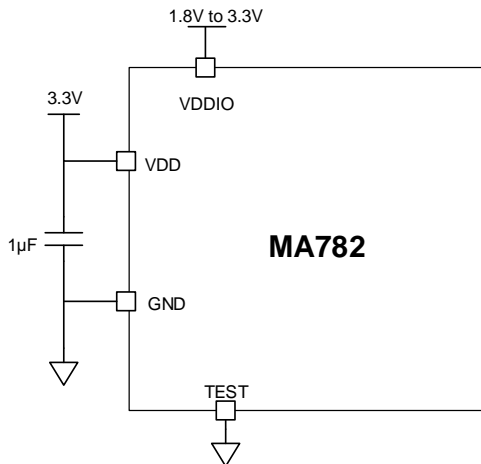
### Externally Controlled

The master controls the MA782's power mode via digital input pins (EN and ASC). Switch between any power mode using these pins.

For more details, see Table 18 and Table 19 on page 23.

### Electrical Mounting and Power Supply Decoupling

It is recommended to place a 1µF decoupling capacitor close to the sensor with a low impedance path to GND (see Figure 9).


**Figure 9: Electrical Mounting and Power Supply Decoupling**

### Start-Up Sequence

VDD should be supplied before or at the same time as VDDIO. After VDD and VDDIO are supplied power, the preconfigured mode (e.g. ASC mode) starts after /CS is set to 1.

### Serial Interface

The sensor supports the serial peripheral interface (SPI) for angle reading and register configuring.

#### Serial Peripheral Interface (SPI)

The SPI is a four-wire, synchronous, serial communication interface. The MA782 supports SPI mode 3 and mode 0. Table 2 shows the SPI specifications.

**Table 2: SPI Specifications**

	Mode 0	Mode 3
<b>SCLK Idle State</b>	Low	High
<b>Data Capture</b>	On SCLK rising edge	
<b>Data Transmission</b>	On SCLK falling edge	
<b>/CS Idle State</b>	High	
<b>Data Order</b>	MSB first	

The SPI mode (0 or 3) is detected automatically by the sensor, and does not require additional action. SPI mode 0 shows more robustness in the data transfer, so it is recommended to be the default communication mode. The maximum clock rate supported on the SPI is 25MHz. There is no minimum clock rate. Real life data rates depend on the PCB layout and signal trace length. See Figure 10, Figure 11, and Table 4 on page 12 for SPI timing.

Table 3 shows the standard SPI values.

**Table 3: SPI Standard**

	Mode 0	Mode 3
<b>CPOL</b>	0	1
<b>CPHA</b>	0	1
<b>Data Order (DORD)</b>	0 (MSB first)	

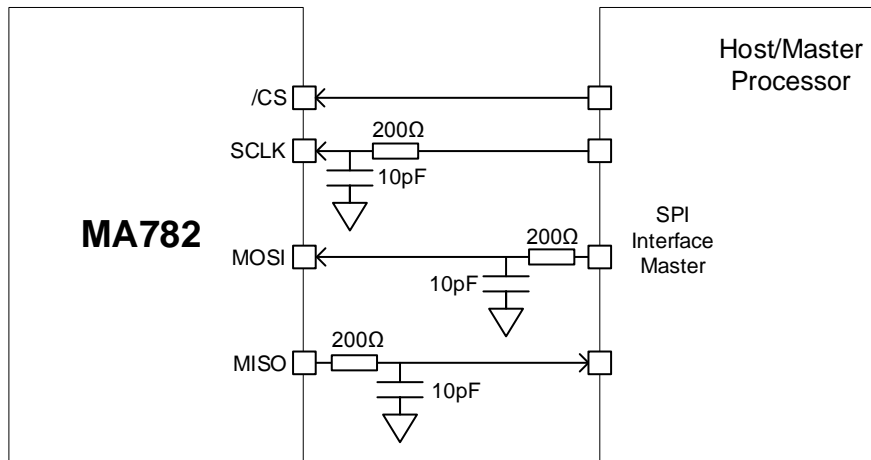
All commands to the MA782 (whether for writing or reading register content) must be transferred through the SPI MOSI pin, and the command must be 16 bits long. See the SPI Communication section on page 13 for details.

#### SPI Signal Routing on a PCB

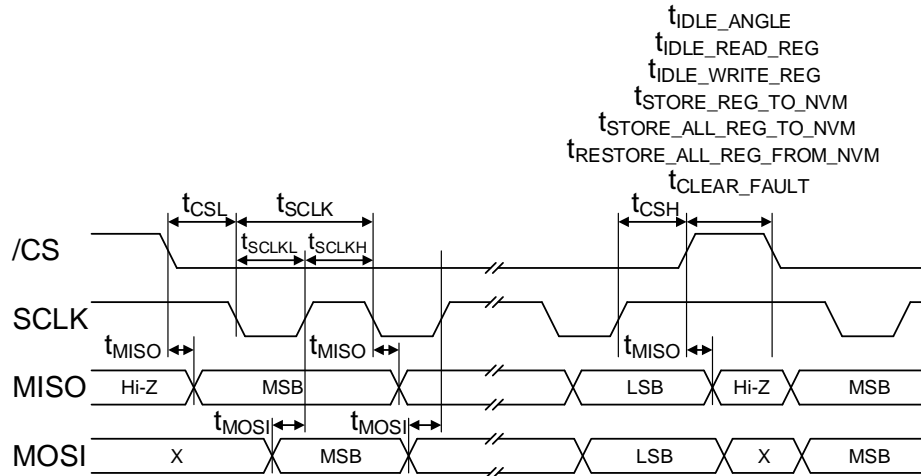
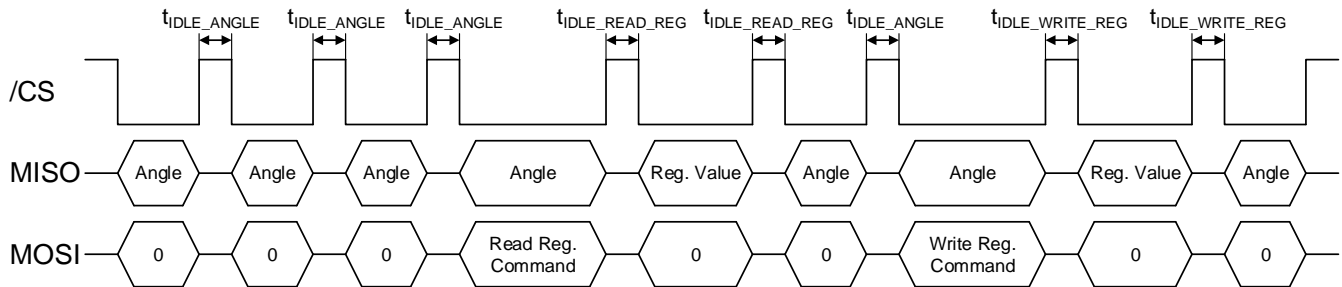
For a reliable data transfer through the SPI bus between the sensor (slave) and the controller (master), special considerations should be made for the PCB design, and the SCLK line in particular. For the best results, follow the guidelines below.

- Properly shield all SPI signals with a GND plane on both sides of each trace, as well as GND plane underneath the SPI signals.
- Place vias along these traces to connect the top and bottom GND planes.
- To avoid EMI issues, route the SCLK signal away from the other SPI signals and noise sources. The distance should be at least three times the SCLK trace width.

- Insert an RC low-pass filter on SCLK (see Figure 10). This RC filter must be located close to the sensor. It is recommended to use a 200Ω serial resistor with a 10pF shunt capacitor to obtain a 80MHz filter cutting frequency.
- Use a star topology for the GND connection, and keep it as direct and short as possible to avoid ground loops.
- Insert RC low-pass filters on the MISO and MOSI signals. The RC filter on MOSI must be located close to the controller, while the filter on MISO must be located close to the sensor. It is recommended to use a 200Ω resistor with a 10pF capacitor.
- Avoid a significant trace length mismatch between the SPI signals, especially between the MISO, MOSI, and SCLK signals. These signals should have similar propagation delays.
- If possible, avoid placing vias on the SCLK signal.



**Figure 10: Examples of RC Low-Pass Filters on the SPI Signals**


**Figure 11: SPI Timing Diagram (Mode 3)**

**Figure 12: Minimum Idle Time**
**Table 4: SPI Timing**

Parameter <sup>(7)</sup>	Description	Min	Max	Units
t <sub>IDLE_ANGLE</sub>	Idle time between two subsequent angle transmissions	120		ns
t <sub>IDLE_READ_REG</sub>	Idle time before and after a register readout	120		ns
t <sub>IDLE_WRITE_REG</sub>	Idle time before and after a register write	120		ns
t <sub>STORE_REG_TO_NVM</sub>	Time required to store a register value to the NVM	23		ms
t <sub>STORE_ALL_REG_TO_NVM</sub>	Time required to store all registers values to the NVM	704		ms
t <sub>RESTORE_ALL_REG_FROM_NVM</sub>	Time required to restore all registers values from the NVM	240		µs
t <sub>CLEAR_FAULT</sub>	Time required to clear the fault flags (register 26)	40		ns
t <sub>CSL</sub>	Time between /CS falling edge and SCLK falling edge	120		ns
t <sub>SCLK</sub>	SCLK period	40		ns
t <sub>SCLKL</sub>	Low level of the SCLK signal	20		ns
t <sub>SCLKH</sub>	High level of the SCLK signal	20		ns
t <sub>CSH</sub>	Time between the SCLK rising edge and /CS rising edge	20		ns
t <sub>MISO</sub>	SCLK falling edge to data output valid		15	ns
t <sub>MOSI</sub>	Data input valid to SCLK rising edge	15		ns

**Note:**

7) All values are guaranteed by design.

### SPI Communication

The sensor supports three types of SPI operation: read angle, read configuration register, and write configuration register. Each operation has a specific frame structure, described below.

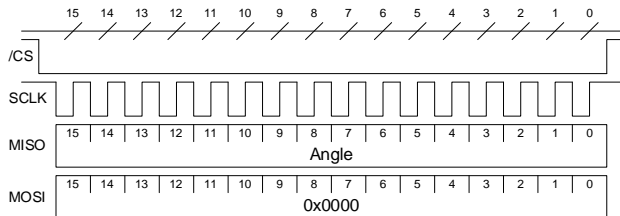
#### SPI Read Angle

Every 1µs, new data is transferred into the output buffer. The master device initiates this process by pulling /CS low. When a trigger event is detected, the data remains in the output buffer until the /CS signal is de-asserted (see Table 5).

**Table 5: Sensor Data Timing**

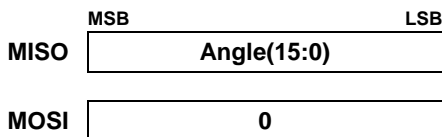
Event	Action
/CS falling edge	Start reading and freeze the output buffer
/CS rising edge	Release the output buffer

Figure 13 shows a diagram of a full SPI angle reading.

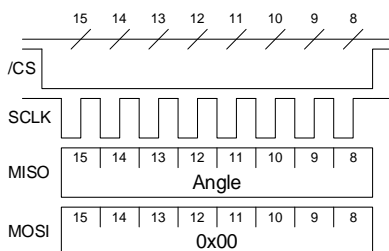


**Figure 13: Diagram of a Full 16-Bit SPI Angle Reading**

A full angle reading requires 16 clock pulses. Then the sensor's MISO line returns:



If less resolution is sufficient, the angle can be read by sending fewer clock counts, since the MSB is first. Figure 14 shows a partial SPI angle reading.



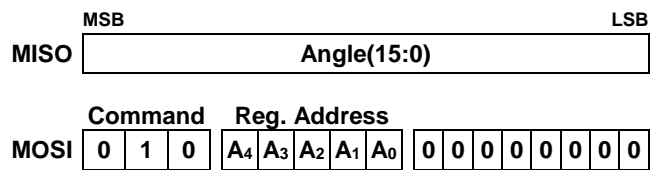
**Figure 14: Diagram of a Partial 8-Bit SPI Angle Reading**

If the reading cycle is shorter than the refresh time, the MA782 continues sending the same data until the data refreshes (for the refresh rate, see the Electrical Characteristics on page 4).

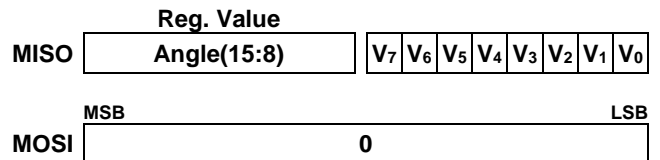
#### SPI Read Register

A read register operation consists of two 16-bit frames. The first frame sends a read request, which contains the 3-bit read command (010) followed by the 5-bit register address. The last 8 bits of the frame must all be set to 0. The second frame returns the 8-bit register value (MSB byte) with an 8-bit angle value.

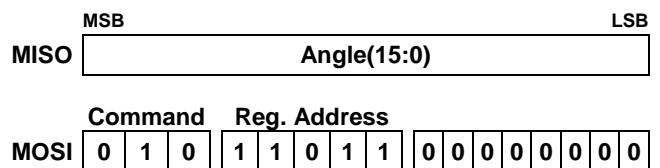
First is the 16-bit SPI frame (read request):



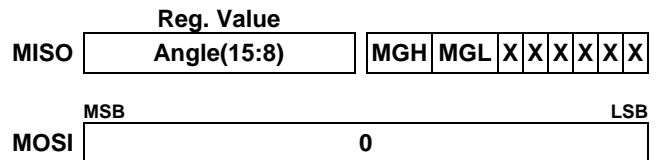
Second is the 16-bit SPI frame (response):



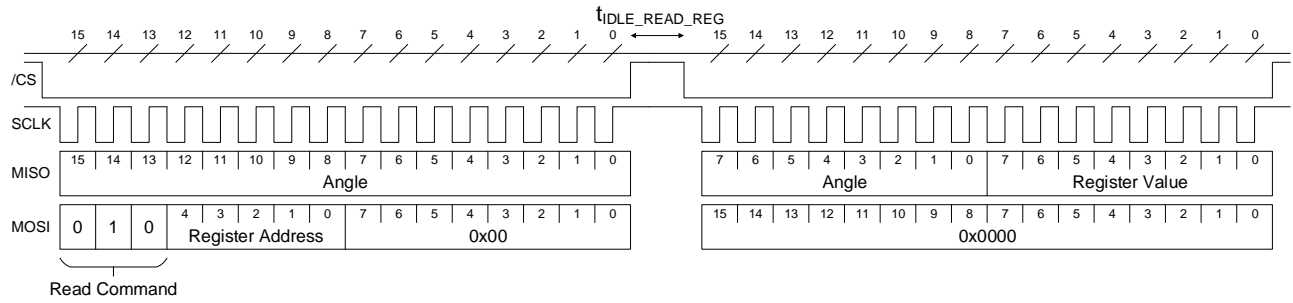
For example, to check the value of the magnetic level high and low flags (MGH and MGL), read register 27 (bit[6] and bit[7]) by sending the following first frame:



In the second frame, the device replies:



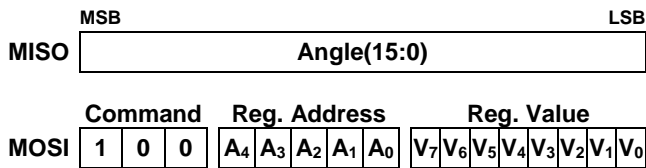
See Figure 15 on page 14 for a complete transmission.


**Figure 15: Two 16-Bit Frames Read Register Operation**

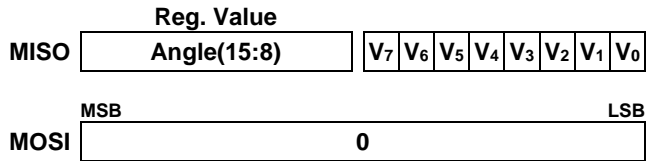
### SPI Write Register

A write register operation is made of two 16-bit frames. The first frame sends a write request, which contains the 3-bit write command (100) followed by the 5-bit register address and the 8-bit value (MSB first). The second frame returns the newly written register value (acknowledge) with an 8-bit angle value.

The first 16-bit SPI frame (write request) is:

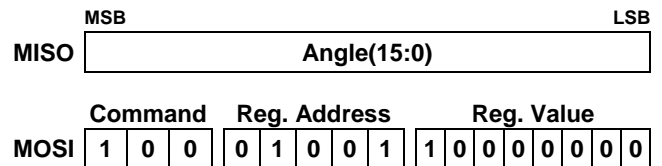


The second 16-bit SPI frame (response) is:

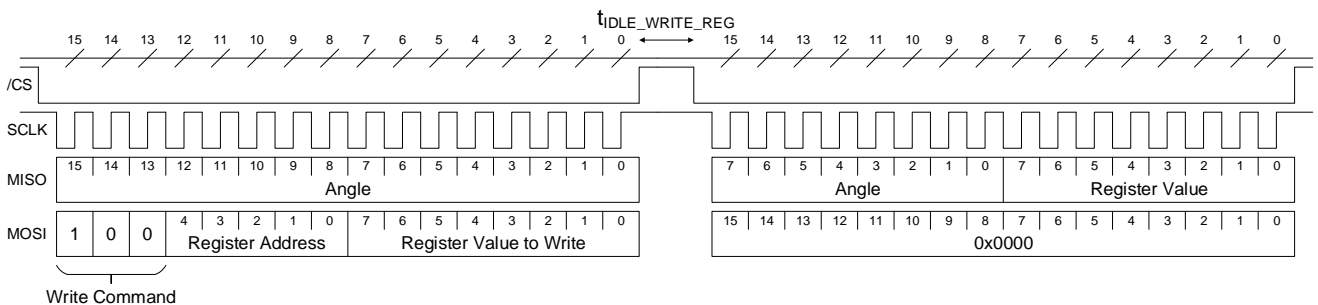
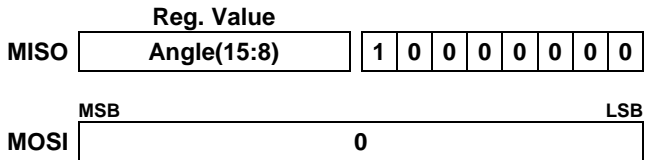


The readback register content can be used to verify the register configurations. Figure 16 shows a complete transmission.

For example, to set the value of the output rotation direction (RD) to counterclockwise (RD bit = 1), write register 9 by sending the following first frame:



Then send the second frame. If the register is written correctly, the reply is:


**Figure 16: Overview of a Write Register Operation with Two 16-Bit Frames**

### Non-Volatile Memory (NVM) Operation

The sensor contains non-volatile memory (NVM) to store the chip configurations during shutdown. The values stored in the NVM are automatically loaded into the sensor's registers during start-up. It is possible to manually force the restoration of the NVM values to the registers, and to store the

registers values to the NVM with different commands.

Restore the NVM values to the registers by using the Restore All Register Values SPI command.

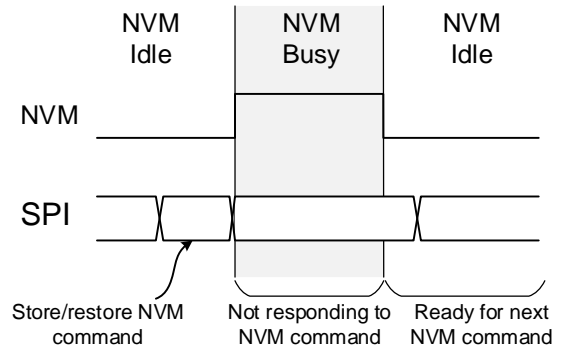
The registers can be stored to the NVM by using two SPI commands:

1. Store a Single Register to the NVM
2. Store All Registers to the NVM

The configuration must first be written to the registers through the write register commands, and then the store commands can save one or all registers to the NVM.

These commands are ignored if the NVM is busy executing a previously received command. To check that the NVM is available and ready to receive a new command, check the NVM pin level.

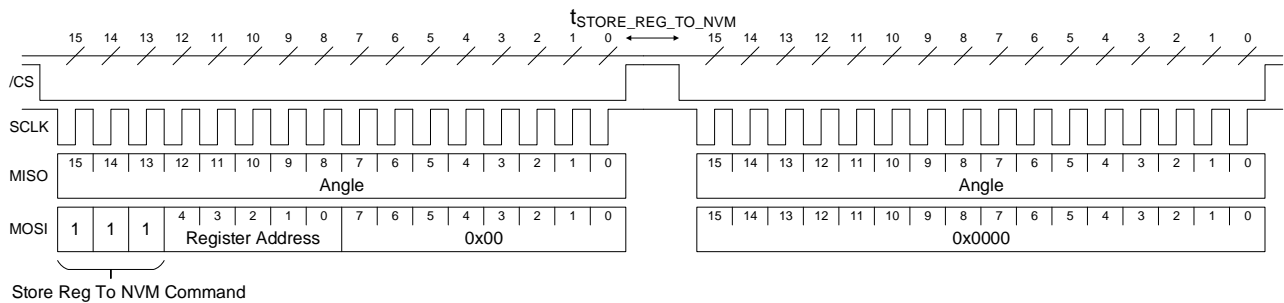
The NVM pin is set high when the non-volatile memory is busy. Store and restore commands are only processed when the NVM pin is set low (see Figure 17).



**Figure 17: Signal Timing for NVM Access**

**SPI Store a Single Register to the NVM**

The current value of a specific register can be stored in the NVM. This command is ignored if the NVM is busy executing a previously received command (see Figure 18).

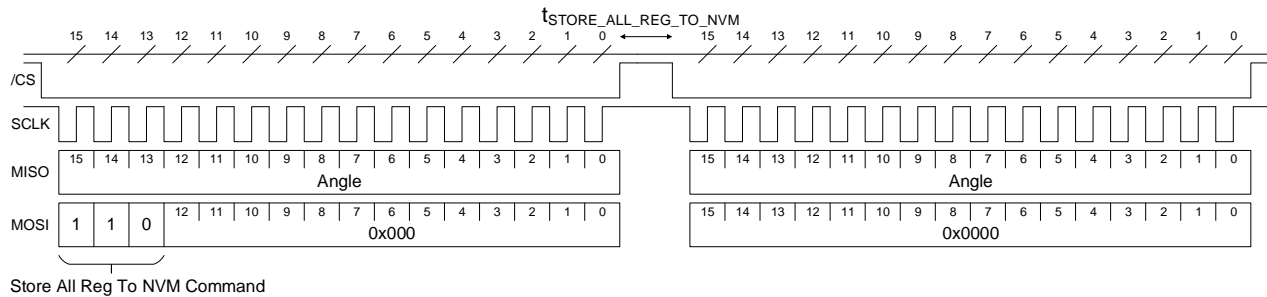


**Figure 18: Overview of Store a Single Register to the NVM Operation with Two 16-Bit Frames**

**SPI Store All Registers to the NVM**

Users can store the current value of all registers to the NVM. This command is ignored if the NVM

is busy executing a previously received command (see Figure 19).

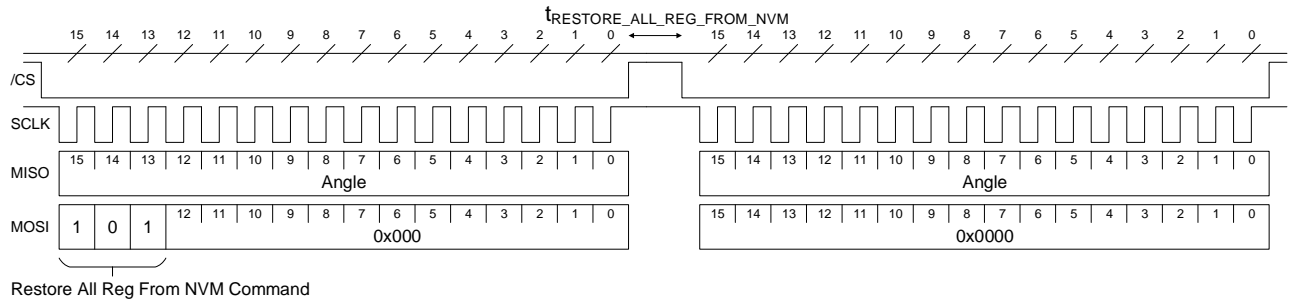


**Figure 19: Overview of Store All Registers to the NVM Operation with Two 16-Bit Frames**

**SPI Restore All Registers from the NVM**

It is possible to restore the value of all registers from the NVM. This operation is done automatically at each power up. This command

is ignored if the NVM is busy executing a previously received command (see Figure 20 on page 16).


**Figure 20: Overview of Restore All Registers from the NVM Operation with Two 16-Bit Frames**

### SPI Clear Error Flags

The error flags in register 26 can be cleared (see Figure 21).

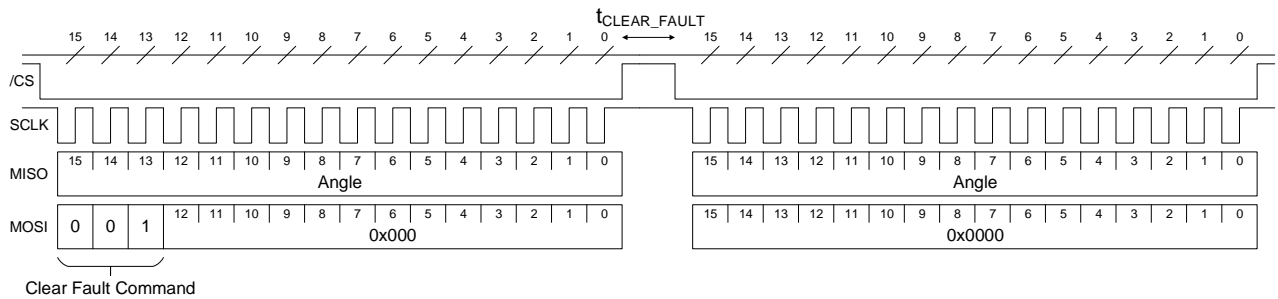

**Figure 21: Overview of Clear Error Flags Operation with Two 16-Bit Frames**

Table 6 shows a summary of all SPI commands.

**Table 6: SPI Command List Overview**

Command Function	Command Bits[15:13]	Register Address Required?	Register Value Required?	Returned Value
Read Angle	000	No	No	16-bit angle
Read Register	010	Yes	No	8-bit angle + register value
Write Register	100	Yes	Yes	8-bit angle + register value
Store Single Register to the NVM	111	Yes	No	16-bit angle
Store All Registers to the NVM	110	No	No	16-bit angle
Restore All Registers from the NVM	101	No	No	16-bit angle
Clear Error Flags	001	No	No	16-bit angle



**REGISTER MAP**
**Table 7: Register Map**

#	Hex	Bin	Bit[7] (MSB)	Bit[6]	Bit[5]	Bit[4]	Bit[3]	Bit[2]	Bit[1]	Bit[0] (LSB)
0	0x0	00000	Z[7:0]							
1	0x1	00001	Z[15:8]							
2	0x2	00010	BCT[7:0]							
3	0x3	00011	-	-	-	-	-	-	ETY	ETX
4	0x4	00100	TCYC[7:0]							
5	0x5	00101	TCYC[15:8]							
6	0x6	00110	MGLT[2:0]			MGHT[2:0]			-	MG
7	0x7	00111	NDM	RAR	HYST[5:0]					
8	0x8	01000	THR[7:0]							
9	0x9	01001	RD	-	-	-	-	-	-	-
10	0xA	01010	REF[7:0]							
11	0xB	01011	ASCR	ASC	-	-	-	-	-	-
14	0xE	01110	FW[3:0]							
26	0x1A	11010	-	-	-	-	ERRPAR	ERRMEM	ERRNVM	-
27	0x1B	11011	MGH	MGL	-	-	-	-	-	-

**Table 8: Factory Default Values**

#	Hex	Bin	Bit[7] (MSB)	Bit[6]	Bit[5]	Bit[4]	Bit[3]	Bit[2]	Bit[1]	Bit[0] (LSB)
0	0x0	00000	0	0	0	0	0	0	0	0
1	0x1	00001	0	0	0	0	0	0	0	0
2	0x2	00010	0	0	0	0	0	0	0	0
3	0x3	00011	0	0	0	0	0	0	0	0
4	0x4	00100	0	1	1	0	1	1	1	0
5	0x5	00101	0	0	0	0	0	0	0	0
6	0x6	00110	0	0	0	1	1	1	0	1
7	0x7	00111	0	0	0	0	0	0	0	0
8	0x8	01000	0	0	0	0	0	0	0	0
9	0x9	01001	0	0	0	0	0	0	0	0
10	0xA	01010	0	0	0	0	0	0	0	0
11	0xB	01011	1	1	0	0	0	0	0	0
14	0xE	01110	1	0	0	1	0	0	0	0

**Table 9: Configuration Parameters**

Parameters	Symbol	# of Bits	Description	See Table
Zero setting	Z	16	Sets the zero position	10
Bias current trimming	BCT	8	For side-shaft configuration: reduces the bias current of the X or Y Hall device	12
Enable trimming X	ETX	1	Biased current trimmed in the X-direction Hall device	13
Enable trimming Y	ETY	1	Biased current trimmed in the Y-direction Hall device	13
Cycle time	TCYC	16	ASC mode: time for an active and idle cycle	21
Magnetic field low threshold	MGLT	3	Sets the field strength low threshold	16
Magnetic field high threshold	MGHT	3	Sets the field strength high threshold	16
Magnetic field strength	MG	1	Enables field strength detection	14
Threshold	THR	8	ASC mode: threshold for change detection	22
ND mode	NDM	1	ND pin logic or latched mode	25
ND pin hysteresis	HYST	6	Determines the hysteresis applied to the ND pin	26
Rotation direction	RD	1	Determines the sensor positive direction	11
Reference	REF	8	ASC mode: angle of reference to detect change	23
Reference auto-refresh	RAR	1	ASC mode: automatically updates the reference at each detection change	24
Automatic sampling cycle	ASC	1	Enables the ASC mode	19
ASC register driven	ASCR	1	Allows ASC mode to be enabled via register settings	19
Filter window	FW	4	Size of the filter window. Determines the resolution	18

## REGISTER SETTINGS

### Zero Setting

The zero position of the MA780 ( $a_0$ ) can be configured with 16 bits of resolution. The angle outputted by the MA782 ( $a_{OUT}$ ) can be calculated with Equation (2):

$$a_{OUT} = a_{RAW} - a_0 \quad (2)$$

Where  $a_{RAW}$  is the raw angle provided by the MA782 front end.

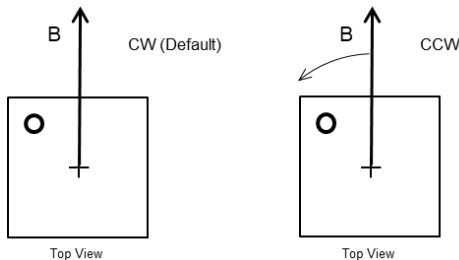
The  $Z[15:0]$  parameter is the zero-angle position coded on 16 bits (see Table 10).

**Table 10: Zero Setting Parameter**

Z[15:0]	$a_0$ (deg)
0	0
1	0.005
2	0.011
...	...
65534	359.989
65535	359.995

### Rotation Direction

By default, when looking at the top of the package, the angle increases when the magnetic field rotates clockwise (CW) (see Figure 22).



**Figure 22: Positive Rotation Direction of the Magnetic Field**

Table 11 lists how to designate the rotation direction.

**Table 11: Rotation Direction Parameter**

RD	Positive Direction
0	Clockwise (CW)
1	Counterclockwise (CCW)

### BCT Settings (Bias Current Trimming)

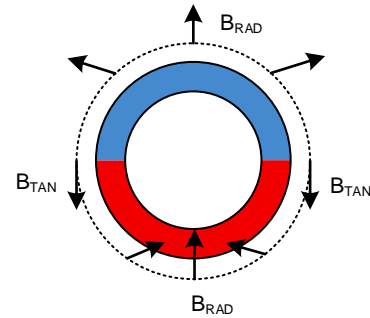
#### Side Shaft

When the MA782 is mounted on the side of the magnet, the relationship between the field angle and the mechanical angle is no longer linear.

This effect is related to the fact that the tangential magnetic field is usually smaller than the radial field. Calculate the field ratio ( $k$ ) with Equation (3):

$$k = B_{RAD}/B_{TAN} \quad (3)$$

Where  $B_{RAD}$  and  $B_{TAN}$  are the maximum radial and tangential magnetic fields (see Figure 23).



**Figure 23: Side-Shaft Field**

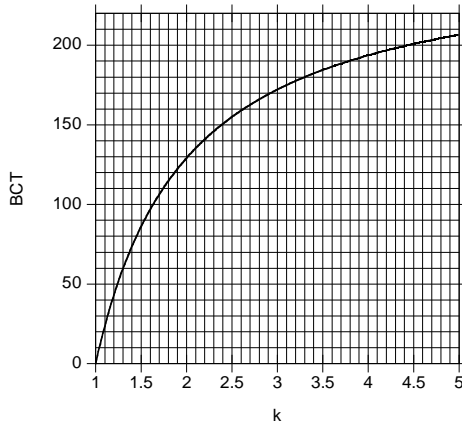
The  $k$  ratio depends on the magnet geometry and the distance to the sensor. If the  $k$  ratio does not equal 1, the sensor output response is nonlinear with respect to the mechanical angle. The error curve has the shape of a double sine wave, where  $E$  is the amplitude of this error (see Figure 24 on page 19). The error curve has the shape of a double sinewave (see Figure 25 on page 19).  $E$  is the amplitude of this error.

The X-axis or the Y-axis bias current can be reduced to recover an equal Hall signal for all angles and suppress the error. The ETX and ETY parameters control the direction in which sensitivity is reduced. The current reduction is set by the bias current trimming parameter ( $BCT[7:0]$ ), which is an integer from 0 to 255.

In a side-shaft configuration (when the sensor's center is located beyond the magnet's outer diameter), the  $k$  ratio exceeds 1. If the value of  $k$  is known,  $BCT[7:0]$  can be calculated with Equation (4):

$$BCT[7:0] = 258 \left( 1 - \frac{1}{k} \right) \quad (4)$$

Figure 24 shows the optimal BCT value for a particular  $k$  ratio.



**Figure 24: Relationship between the  $k$  Ratio and the Optimal BCT to Recover Linearity**

Table 12 shows typical BCT values.

**Table 12: Example of BCT Settings**

E (deg)	Magnet Ratio ( $k$ )	BCT[7:0]
0	1.0	0
11.5	1.5	86
19.5	2.0	129
25.4	2.5	155
30.0	3.0	172
33.7	3.5	184
36.9	4.0	194
39.5	4.5	201
41.8	5.0	207

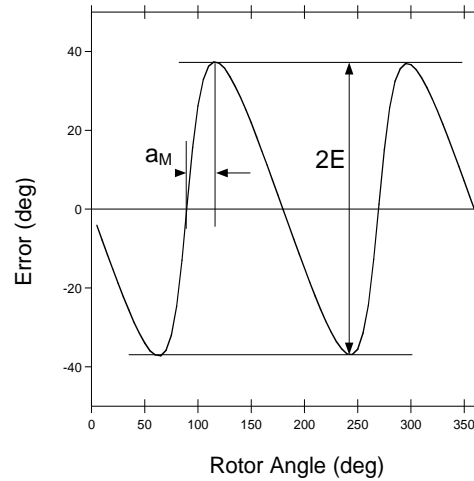
**Determining  $k$**

The  $k$  ratio can be deduced from the error curve obtained with the default BCT setting (BCT = 0). Rotate the magnet more than one revolution and record the device’s output.

Next, plot the error curve (the output minus the real mechanical position vs. the real mechanical position) and extract two parameters: the maximum error ( $E$ ), and the position of the maximum with respect to a zero crossing ( $a_M$ ) (see Figure 27). The  $k$  ratio can be calculated with Equation (5):

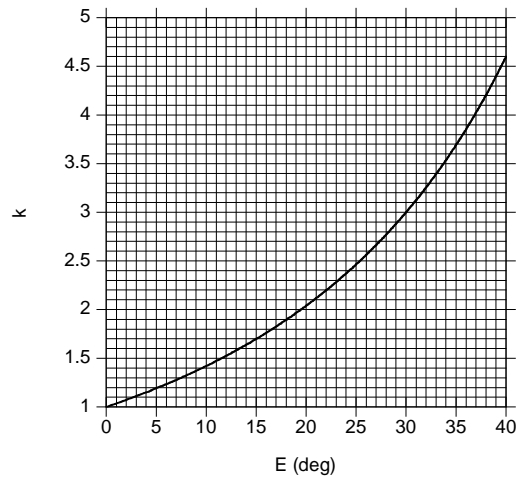
$$k = \frac{\tan(E + a_M)}{\tan(a_M)} \quad (5)$$

Figure 25 shows the error curve.



**Figure 25: Error Curve in Side-Shaft Configuration (BCT = 0)**

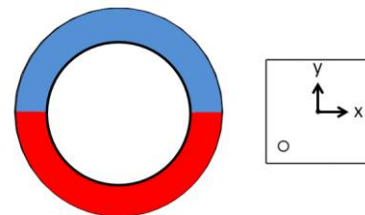
Alternatively, the value of  $k$  can be obtained using Figure 26.



**Figure 26: Relationship between the Error Measured with BCT = 0 and the Magnet Ratio  $k$**

**Sensor Orientation**

The dot marked on the package indicates whether the radial field is aligned with the sensor coordinate X or Y (see Figure 27).



**Figure 27: Package Top View with X- and Y-Axes**

Determine which axis should be reduced based on the qualitative field distribution around a ring (see Figure 23 on page 19).

For example, Figure 27 on page 20 shows that the field along the sensor’s Y direction is tangential and weaker. This means that the X-axis should be reduced (ETX = 1 and ETY = 0).

If both ETX and ETY are set to 1, the current bias is reduced in both directions the same way (i.e. without side-shaft correction) (see Table 13). This reduces the sinusoidal signal from Figure 2 on page 8, which modifies the magnetic field thresholds.

Table 13: Trimming Direction Parameters

<b>ETX</b>	<b>Enable Trimming of the X-Axis</b>
0	Disabled
1	Enabled
<b>ETY</b>	<b>Enable Trimming of the Y-Axis</b>
0	Disabled
1	Enabled

**Magnetic Field Thresholds**

The magnetic flags indicate that the magnetic field at the sensor position is outside the range defined by the lower (MGLT) and upper (MGHT) magnetic field thresholds. Figure 28 shows this relationship.

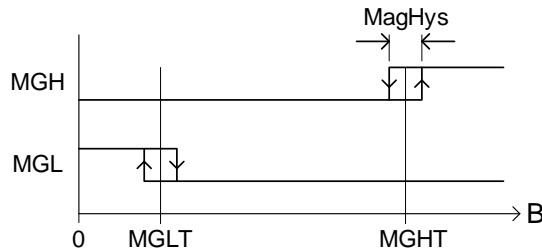


Figure 28: MGH and MGL Signals as a Function of the Field Strength

To enable the magnetic field strength measurements, the MG parameter must be set to logic 1 (see Table 14).

Table 14: Magnetic Field Strength

<b>MG</b>	<b>Field Strength Measurement</b>
0	Disabled
1	Enabled

MagHys, the typical hysteresis on the MGH and MGL signals, is 6mT. The MGLT and MGHT

thresholds are coded on 3 bits and stored in register 6 (see Table 15).

Table 15: Register 6

Register 6							
Bit[7]	Bit[6]	Bit[5]	Bit[4]	Bit[3]	Bit[2]	Bit[1]	Bit[0]
MGLT			MGHT			-	-

The 3-bit values of MGLT and MGHT correspond to the magnetic field (see Table 16).

Table 16: MGLT and MGHT: Binary to mT Relation

MGLT or MGHT <sup>(9)</sup>	Field Threshold (mT) <sup>(8)</sup>	
	Low-to-High Magnetic Field	High-to-Low Magnetic Field
000	26	20
001	41	35
010	56	50
011	70	64
100	84	78
101	98	92
110	112	106
111	126	120

**Notes:**

- 8) Valid when V<sub>DD</sub> = 3.3V. If different from the field threshold, scale by the factor V<sub>DD</sub> / 3.3V. When ETX = 1 and ETY = 1, it is possible to increase the field thresholds by increasing BCT.
- 9) MGLT can have a larger value than MGHT.

The alarm flags (MGL and MGH) can be read in register 27 (bit[6] and bit[7]), and the logic state of MGL is provided by the MGL pin.

To retrieve the MGL and MGH flags by the SPI, send the 8-bit command read to register 27:

Command	Reg. Address	MSB	Value	LSB
0 1 0	1 1 0 1 1	0	0 0 0 0 0 0 0 0	0

The MA782 answers with the register 27 content in the next transmission (see Table 17).

Table 17: R[7:0]

R[7:0]							
MGH	MGL	x	x	x	x	x	x

**Error Flags**

Register 26 contains information about the sensor’s operational integrity.

**ERRPAR**

When using 17-bit communication on the SPI bus, the SPI write register command sent by the

controller to the sensor can be checked for parity (unlike the other commands). The controller sends a parity bit on the MOSI line after the 16-bit command. The sensor checks the parity of the 17-bit long command. If there is a parity error, then the data to be written to the register is discarded and the ERRPAR bit asserts (set to 1).

### ERRMEM

The ERRMEM bit is asserted (set to 1) under one the following conditions:

1. A SPI write register command is sent while the NVM is busy (the NVM pin set to 1).
2. In ASC mode, an SPI write register command is sent while the sensor is active.

To avoid raising the ERRMEM flag, the user must ensure that no SPI write is sent while the NVM pin is high (set to 1). Ensure that a write command is only sent when the sensor is idle in ASC mode.

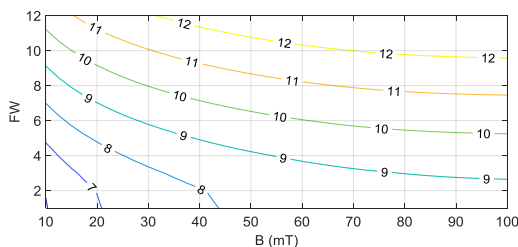
It is also recommended to check that the register value returned by the SPI write register command matches the desired written value (see the SPI Write Register section on page 14).

### ERRNVM

Restoring register values from the NVM is secured by a cyclic redundancy check (CRC) algorithm. If the generated CRC result does not match the stored value (called a mismatch), the ERRNVM bit asserts (set to 1). If any error flag is asserted, the ERR pin is set to logic 1. Clear the status byte by sending the SPI Clear Error Flags command.

### Filter Window Size

The filter window (FW) determines the effective resolution (defined as the  $\pm 3\sigma$  noise interval). Figure 29 shows the effective resolution for different FWs and the magnetic field (B).



**Figure 29: MA782 Resolution**

Since FW modifies the filter time constant ( $\tau$ ), FW impacts the output bandwidth. The upper limit of the bandwidth and the cutoff frequency ( $f_{\text{CUTOFF}}$ ) are related to  $\tau$ .  $f_{\text{CUTOFF}}$  can be estimated with Equation (6):

$$f_{\text{CUTOFF}} = 0.16 / \tau \quad (6)$$

When the MA782 enters active mode (whether via external control or during ASC mode), the filter window has to settle. Therefore, the angle output is not stable until a certain amount of time is passed, called the filter settling time. This time is indicated by the raise of the data valid flag (DV output pin). Table 18 gives the settling time for each window size.

**Table 18: Filter Window Size <sup>(10)</sup>**

Filter Window FW[3:0]	$\tau$ ( $\mu\text{s}$ )	Filter Settling Time ( $\mu\text{s}$ )	$f_{\text{CUTOFF}}$ (Hz)
0	1	1	160,000
1	2	3	79,600
2	4	7	39,800
3	8	15	19,890
4	16	31	9,950
5	32	63	4,970
6	64	127	2,490
7	128	255	1,240
8	256	511	622
9	512	1023	311
10	1024	2047	155
11	2048	4095	78
12	4096	8191	39
13	4096	8191	39
14	4096	8191	39
15	4096	8191	39

**Note:**

10) See the Electrical Characteristics section on page 4 for the filter settling time accuracy.

### Latency

The latency is the difference between the true position of the mechanical angle and the angle reading that is available on the SPI interface. Latency is a function of the filter time constant ( $\tau$ ). Assuming that MA782 is continuously in active mode, the latency at a constant rotation speed is  $\tau + 3\mu\text{s}$ . In real applications, consider the latency. For a larger  $\tau$ , the latency increases. If the latency is high, limit the rotation speed so that the angle error caused by latency is acceptable.

### Low-Power Operation

For an overview of the three power modes (active, idle, or ASC mode), see the Power Modes section on page 9. Table 19 shows how to select the power modes.

**Table 19: Power Modes Selection** <sup>(11)</sup>

EN (Pin)	ASC (Pin)	ASC (Reg.)	ASCR (Reg.)	Mode
0	0	x	0	Idle
0	1	x	0	ASC
0	x	0	1	Idle
0	x	1	1	ASC
1	x	x	x	Active

**Note:**

11) “x” means not applicable.

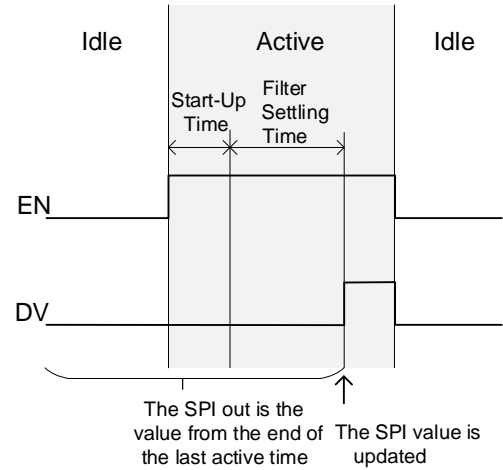
See Table 20 for examples of settings.

**Table 20: Typical Setting for Mixed Operation**

Modes	Pin for Switching	Preset Example
ASC only	None	EN = 0 ASCR = 1 ASC (Reg.) = 1
Active to idle	EN	ASCR = 1 ASC (Reg.) = 0
Active to ASC	EN	ASCR=1 ASC (Reg.) = 1
ASC to idle	ASC	EN = 0 ASCR = 0

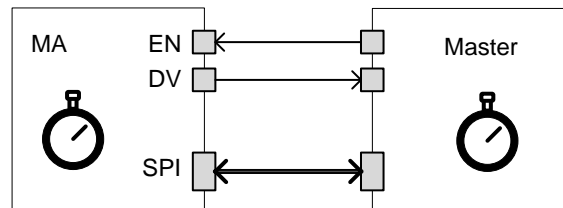
### Externally Switching Between Active Mode and Idle Mode

Pulling the EN pin high activates the MA782. After the filter settling time, the DV signal indicates that the measurement is stable. The master can send the MA782 back to idle mode while the angle remains in the MA782 output buffer, and the SPI remains active to allow data reading (see Figure 30).



**Figure 30: Signal Timing for External Control**

Figure 31 shows the typical configuration to switch between active mode and idle mode.



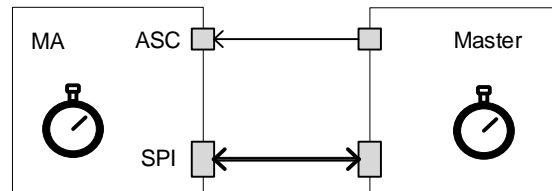
**Figure 31: Typical Configuration to Switch Between Active Mode and Idle Mode**

### Mixed Operation (Active Mode and ASC Mode)

It is possible to switch between a low-power ASC mode and a high-power active mode by driving the EN pin high or low, respectively. This allows for high-rate, full power measurements after certain angle changes are detected in ASC mode.

### Mixed Operation (ASC Mode and Idle Mode)

When switching the MA782 between ASC and idle mode, drive the ASC state using the ASC pin or register. ASC mode is activated when ASC is high. In this configuration, the angle is updated when the device is in ASC mode (see Figure 32).



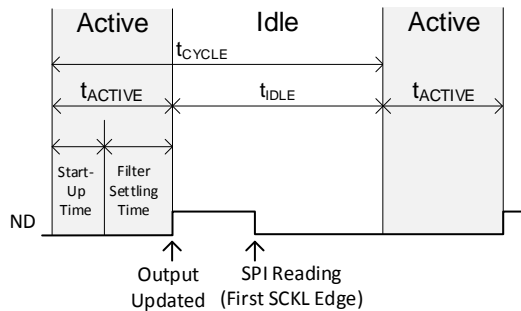
**Figure 32: Typical Configuration to Switch between ASC Mode and Idle Mode using the ASC Pin**

### Configurations for ASC Mode

The power cycles are defined by the active time and the cycle time. The active time is automatically adjusted according to the filter window, such that the active time ends when the filter has settled. The active time ( $t_{ACTIVE}$ ) can be calculated with Equation (7):

$$t_{ACTIVE} = t_{START-UP} + t_{SETTLING} \quad (7)$$

Where  $t_{SETTLING}$  can be determined with Table 18 on page 22. ASC mode is recommended for most applications. Figure 33 shows the timing for an ASC cycle.



**Figure 33: Timing of a ASC Cycle**

Note that the master device can read the sensor angle at any time.

TCYC is directly configured by the user. The cycle time must be longer than the active time (see Table 21). Otherwise the cycle time increases by an integer until it is longer than  $t_{ACTIVE}$ .

**Table 21: Cycle Time**

TCYC	Cycle time (ms)
0	Continuously idle
1	Do not use
2	0.2
3	0.3
4	0.4
...	...
65535	6553.5

For the cycle time accuracy, see the Electrical Characteristics section on page 4.

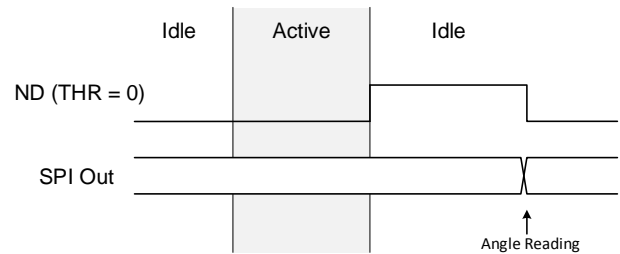
Once the  $t_{ACTIVE}$  and the TCYC parameter are set, the average current consumption ( $I_{AVERAGE}$ ) can be estimated with Equation (8):

$$I_{AVERAGE} = I_{ACTIVE} \times \frac{t_{ACTIVE}}{t_{CYCLE}} + I_{IDLE} \times \left(1 - \frac{t_{ACTIVE}}{t_{CYCLE}}\right) \quad (8)$$

### New Data (ND) Pin

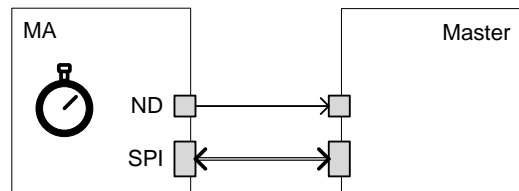
The new data (ND) signal has different use cases, depending on the low-power mode. ND can indicate the end of an active period or detect a predefined motion.

By default, the ND signal rises after each active phase, and latches to indicate that a new value is available in the output buffer. ND resets after the first reading of the angle (see Figure 34). This default state occurs when  $NDM = 0$  and  $THR = 0$ .



**Figure 34: Using the ND Pin in Latch Mode as a Flag for Data Updates ( $NDM = 0$ ,  $THR = 0$ )**

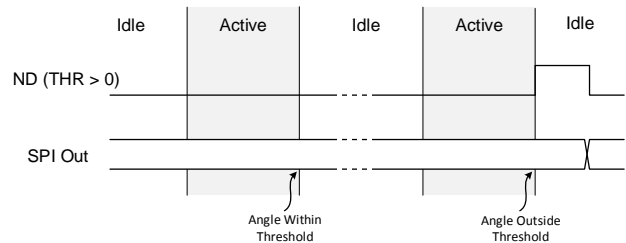
Figure 35 shows a simple connection to use this feature of the ND pin.



**Figure 35: Reading Both the SPI and ND**

### Threshold (THR)

If the threshold (THR) parameter is configured to a non-zero value, the ND pin becomes a warning on change (WOC) signal (see Figure 36).



**Figure 36: ND Pin Used at WOC Signal with a Non-Zero Threshold Setting (Latch Mode)**

The THR parameter is a relative angle coded on 8 bits (see Table 22 on page 25). If THR is greater than 180, the ND flag is disabled.



**Table 22: Threshold for Wake Up**

THR[6:0]	Threshold (deg)
0	0
1	1.41
2	2.81
...	...
127	178.59
128	180 (ND flag only at 180°)
129	181.41 (no ND flag)
...	...
255	358.59 (no ND flag)

**Reference (REF)**

The angle change is defined in relation to the reference angle. This angle is controlled by the REF parameter. The ND pin goes high when the angle distance to REF exceeds the threshold.

REF is an absolute angle coded on 8 bits (see Table 23).

**Table 23: Change Detection Fixed Reference**

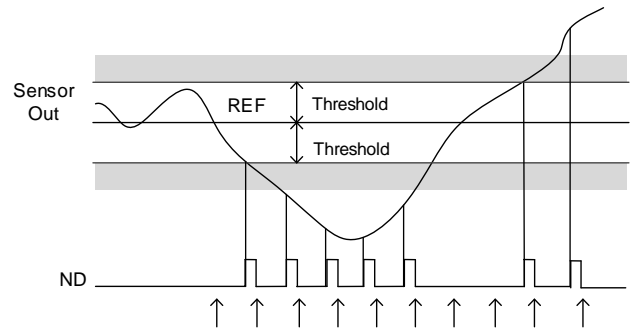
REF[7:0]	Reference (deg)
0	0
1	1.41
2	2.81
...	...
255	358.59

REF can either be a fixed value, or it can be automatically updated when the threshold is crossed. This allows the device to detect an incremental change rather than the change of an absolute position. Use the reference automatic refresh bit (RAR) to select between these two references methods (see Table 24).

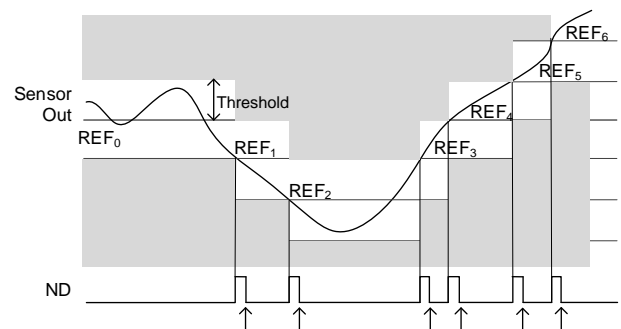
**Table 24: Wake-Up on Change Mode**

RAR	Reference
0	Remains fixed
1	Automatically updated

If RAR = 0 (fixed at the reference position), the ND pin goes high when the angle is outside the fixed threshold (see Figure 37). The arrows indicate SPI readings.


**Figure 37: Example of the ND Signal when the Angle Changes**

If RAR = 1, REF is automatically updated each time the threshold is crossed (see Figure 38). The arrows indicate SPI readings.


**Figure 38: Example of the ND Signal when the Angle Changes (RAR = 1)**

In this scenario, the user value is automatically updated. The new value of REF is the sensor output value at the moment when the threshold was crossed.

**ND Mode (NDM)**

By default the ND flag is reset by an SPI reading. This is called latched mode. In some cases, the user might want to detect an absolute threshold (RAR = 0) without being forced to reset the ND state by SPI. To accomplish this, the ND pin can be set as logic level mode instead of latched mode using the NDM bit in register 7 (see Table 25).

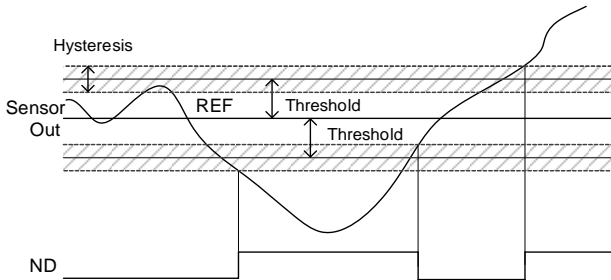
**Table 25: ND Pin Mode Parameters**

NDM	Mode
0 (default)	Latched
1	Logic Level

In latched mode, the ND pin is reset on the first SCLK rising edge of the following SPI commands: Read Angle, Store Registers to the NVM, Restore Registers from the NVM, and

Clear Status Byte. The ND flag is not reset by writing or reading the registers.

In logic level mode, the ND signal is updated every 1µs, which reflects the condition status (i.e. the relationship between the angle’s output value, angle threshold, and angle reference) in real time (see Figure 39).



**Figure 39: ND Signal in Logic Level Mode when Hysteresis is Applied**

In this mode, the ND signal status is not reset when SPI reads the angle. To avoid repeated ND pin transitions around the threshold, configure a hysteresis via the HYST[5:0] in register 7. The hysteresis can be calculated with Equation (9):

$$\text{Hysteresis} = \frac{11.25^\circ}{64} \times \text{HYST}[5:0] \quad (9)$$

HYST[5:0] is 0 by default (see Table 26).

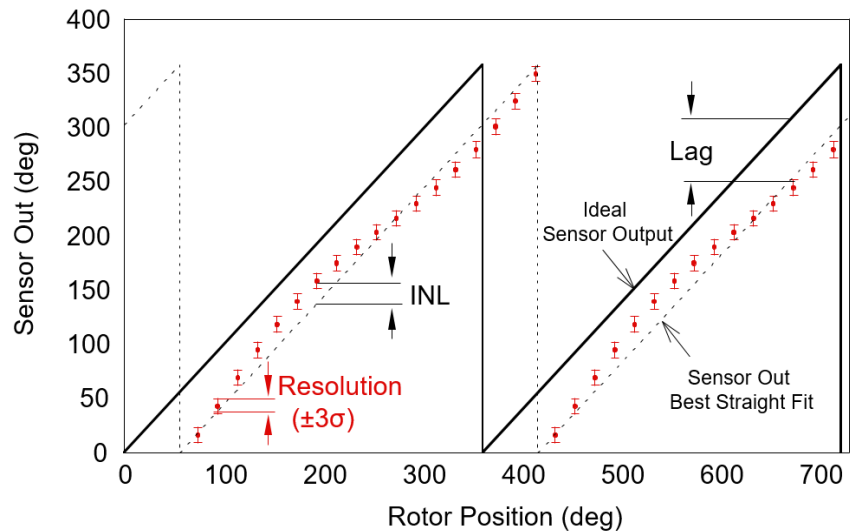
**Table 26: ND Pin Hysteresis Setting**

HYST[5:0]	HYST (deg)
000000	0
...	...
111111	11.07

Note that HYS[5:0] affects the hysteresis of the ND pin whether NDM is 0 or 1. When RAR = 1 and NDM = 1, the ND pin is reset immediately after being set, generating a short pulse.

**APPENDIX A: DEFINITIONS**

<b>Effective Resolution (3σ Noise Level)</b>	Smallest angle increment distinguishable from the noise. The resolution is measured by computing three times σ (the standard deviation in degrees) taken over 1,000 data points at a constant position. The bit resolution is calculated as: $\log_2(360 / 6\sigma)$ .
<b>Refresh Rate</b>	Rate at which new data points are stored in the output buffer.
<b>Latency</b>	The time elapsed between the instant when the data is ready to be read and the instant at which the shaft passes that position. The lag in degrees is $\text{lag} = \text{latency} \times v$ , where $v$ is the angular velocity (in deg/s).
<b>Power-Up Time</b>	Time until the sensor delivers valid data starting at power up (when the voltage supply is established).
<b>Start-Up Time</b>	Time until the sensor front end delivers valid data to the digital treatment block when recovering from idle mode.
<b>Filter Settling Time</b>	Time for the filter to deliver a stable angle (i.e. when the error is smaller than the noise at the particular filter window setting).
<b>Integral Nonlinearity (INL)</b>	Maximum deviation between the average sensor output (at a fixed position) and the true mechanical angle (see Figure A1).


**Figure A1: Resolution, INL, Lag**

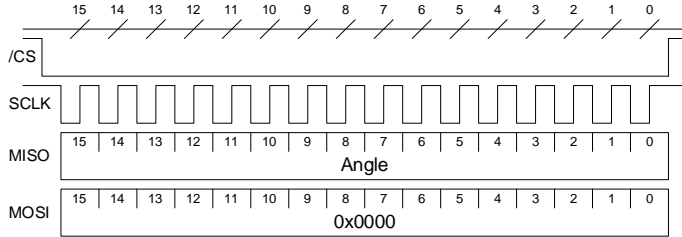
INL can be obtained from the error curve  $\text{err}(a) = \text{out}(a) - a$ , where  $\text{out}(a)$  is the average output across 1000 sensor outputs, and  $a$  is the mechanical angle indicated by a high precision encoder ( $<0.001$  deg). INL can be calculated with Equation (A1):

$$\text{INL} = \frac{\max(\text{err}(a)) - \min(\text{err}(a))}{2} \quad (\text{A1})$$

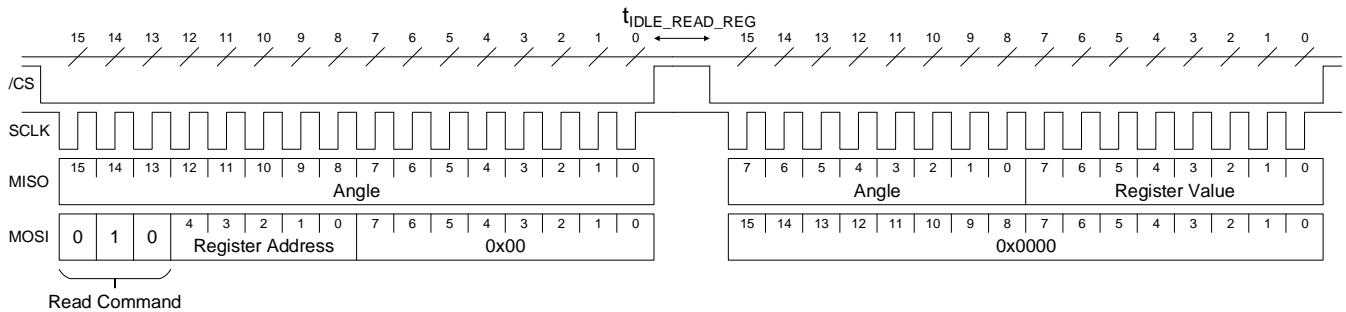
**Drift** The angle variation rate when one parameter is changed (e.g. temperature,  $V_{DD}$ ) while all the others, such as the shaft angle, remain constant.

## APPENDIX B: SPI COMMUNICATION CHEATSHEET

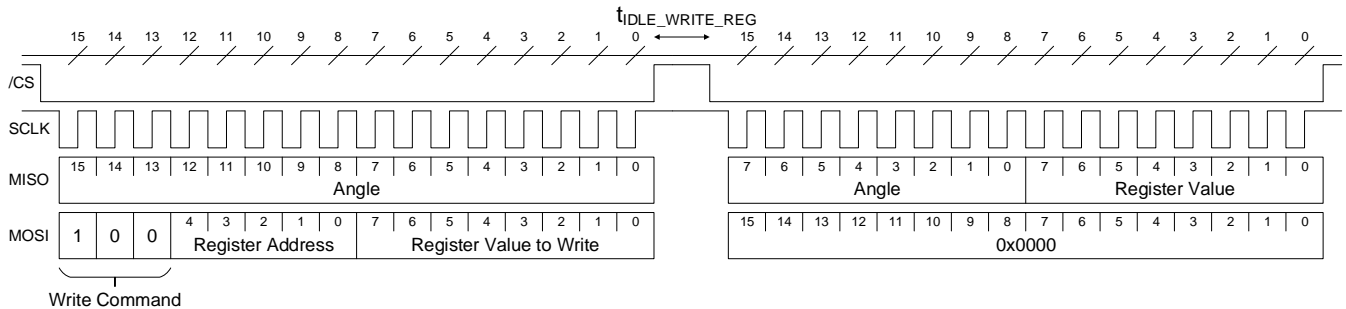
### Read Angle (see the SPI Read Angle section on page 13)



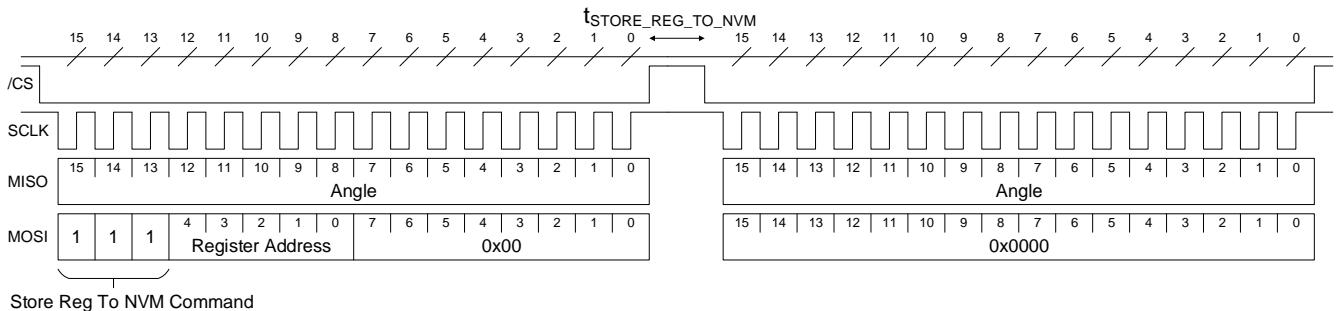
### Read Register (see the SPI Read Register section on page 13)

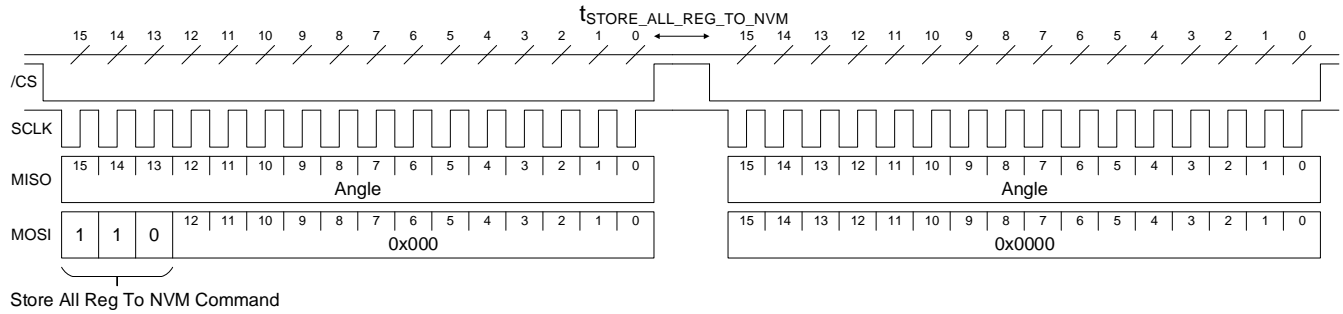
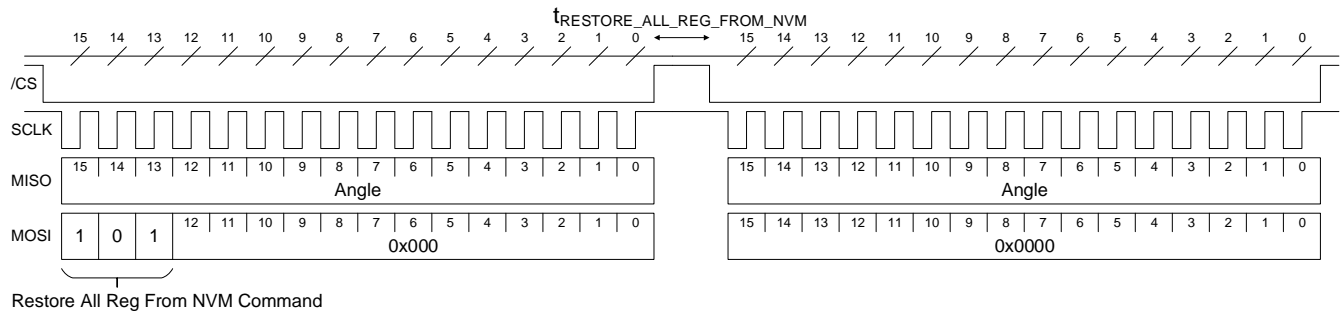
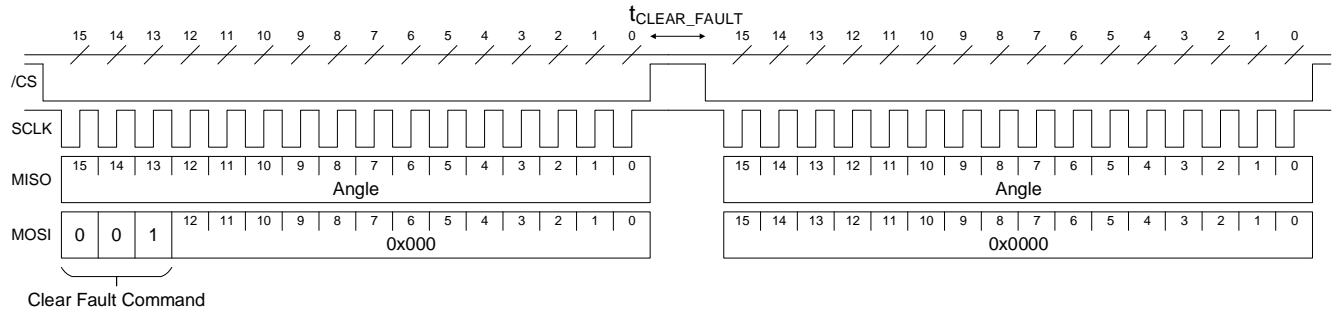


### Write Register (see the SPI Write Register section on page 14)



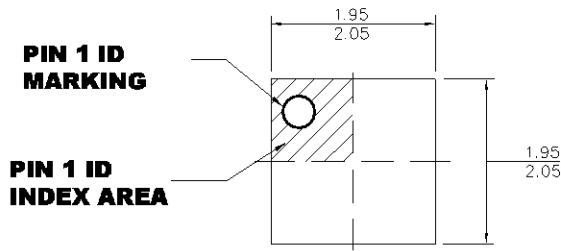
### Store a Single Register Value to the NVM (see the SPI Store a Single Register to the NVM section on page 15)



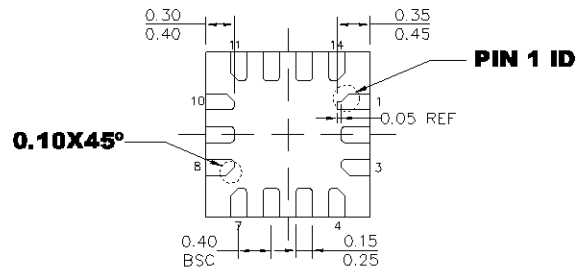
**Store All Register Values to the NVM (see the SPI Store All Registers to the NVM section on page 15)**

**Restore All Register Values from the NVM (see the SPI Restore All Registers from the NVM section on page 15)**

**Clear Error Flags (see the SPI Clear Error Flags section on page 16)**


PACKAGE INFORMATION

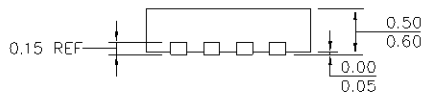
QFN-14 (2mmx2mm)



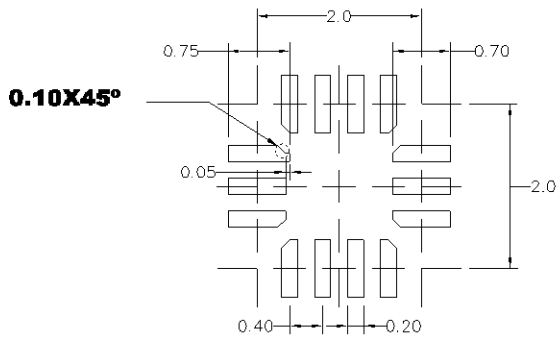
**TOP VIEW**



**BOTTOM VIEW**



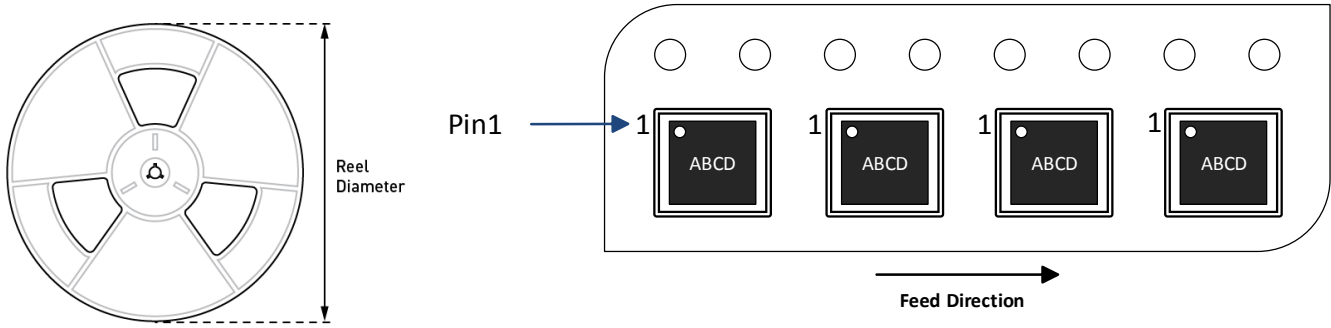
**SIDE VIEW**



**RECOMMENDED LAND PATTERN**

**NOTE:**

- 1) ALL DIMENSIONS ARE IN MILLIMETERS.
- 2) LEAD COPLANARITY SHALL BE 0.08 MILLIMETERS MAX.
- 3) JEDEC REFERENCE IS MO-220.
- 4) DRAWING IS NOT TO SCALE.

**CARRIER INFORMATION**


Part Number	Package Description	Quantity/ Reel	Quantity/ Tube	Quantity/ Tray	Reel Diameter	Carrier Tape Width	Carrier Tape Pitch
MA782GGU-Z	QFN-14 (2mmx2mm)	5000	N/A	N/A	13in	12mm	8mm

## REVISION HISTORY

Revision #	Revision Date	Description	Pages Updated
1.0	06/22/2021	Initial Release	-
1.1	08/30/2021	Updated the Table 20 values	23
		Grammar and formatting updates; updated footnote numbers	All

**Notice:** The information in this document is subject to change without notice. Users should warrant and guarantee that third-party Intellectual Property rights are not infringed upon when integrating MPS products into any application. MPS will not assume any legal responsibility for any said applications.



## X-ON Electronics

Largest Supplier of Electrical and Electronic Components

*Click to view similar products for* [Board Mount Hall Effect/Magnetic Sensors](#) *category:*

*Click to view products by* [Monolithic Power Systems](#) *manufacturer:*

Other Similar products are found below :

[HGPRDT005A](#) [AH1808-P-A](#) [AH277AZ4-AG1](#) [AV-10379](#) [AV-10448](#) [SS41C](#) [AH1803-WG-7](#) [AH1894-Z-7](#) [TLE4917](#) [50017859-003](#) [TY-13101](#) [TLE4976L](#) [SS85CA](#) [BU52002GUL-E2](#) [BU52003GUL-E2](#) [AH277AZ4-BG1](#) [TLE49614MXTSA1](#) [AH211Z4-AG1](#) [AH3360-FT4-7](#) [TLE4961-3M](#) [TLE4941-1](#) [SS460S-100SAMPLE](#) [50065820-03](#) [TLE4941PLUSCB](#) [AH374-P-A](#) [AH1806-P-A](#) [TLE49595UFXHALA1](#) [SS460P-T2](#) [AH1913-W-7](#) [TLE9852QXXUMA1](#) [MA732GQ-Z](#) [MA330GQ-Z](#) [TLE5046ICAKLRHALA1](#) [TLE49421CHAMA2](#) [AH1903-FA-EVM](#) [AH49FNTR-EVM](#) [AH8502-FDC-EVM](#) [AH3774-P-EVM](#) [TLE4998S3XALA1](#) [TLE5011FUMA1](#) [TLE5027CE6747HAMA1](#) [TLE5109A16E1210XUMA1](#) [TLI4966GHTSA1](#) [TLI4906KHTSA1](#) [MA710GQ-P](#) [EDC159S-A-30Y-97-5](#) [XR3\(xp8t\)](#) [S-57K1NBL2A-M3T2U](#) [S-57P1NBL9S-M3T4U](#) [S-576ZNL2B-L3T2U](#)