



The Future of Analog IC Technology®

MP2159

1A, 6V, 1.5MHz, 17µA I_Q, COT
Synchronous Step Down Switcher
In 8-pin TSOT23

DESCRIPTION

The MP2159 is a monolithic step-down switch mode converter with built-in internal power MOSFETs. It achieves 1A continuous output current from a 2.5V to 6V input voltage with excellent load and line regulation. The output voltage can be regulated as low as 0.6V.

The Constant-On-Time control scheme provides fast transient response and eases loop stabilization. Fault condition protection includes cycle-by-cycle current limiting and thermal shutdown.

The MP2159 is available in the small TSOT23-8 package and requires a minimum number of readily available standard external components.

The MP2159 is ideal for a wide range of applications including High Performance DSPs, FPGAs, PDAs, and portable instruments.

FEATURES

- Very Low I_Q: 17µA
- Default 1.5MHz Switching Frequency
- EN and Power Good for Power Sequencing
- Wide 2.5V to 6V Operating Input Range Output Adjustable from 0.6V
- Up to 1A Output Current
- 100% Duty Cycle in Dropout
- 118mΩ and 88mΩ Internal Power MOSFET Switches
- Cycle-by-Cycle Over Current Protection
- Short Circuit Protect with Hiccup Mode
- Stable with Low ESR Output Ceramic Capacitors
- Available in a TSOT23-8 Package

APPLICATIONS

- Wireless/Networking Cards
- Portable Instruments
- Battery Powered Devices
- Low Voltage I/O System Power

All MPS parts are lead-free and adhere to the RoHS directive. For MPS green status, please visit MPS website under Products, Quality Assurance page. "MPS" and "The Future of Analog IC Technology" are registered trademarks of Monolithic Power Systems, Inc.

TYPICAL APPLICATION

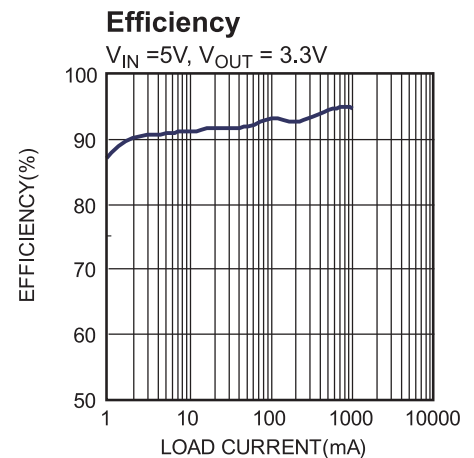
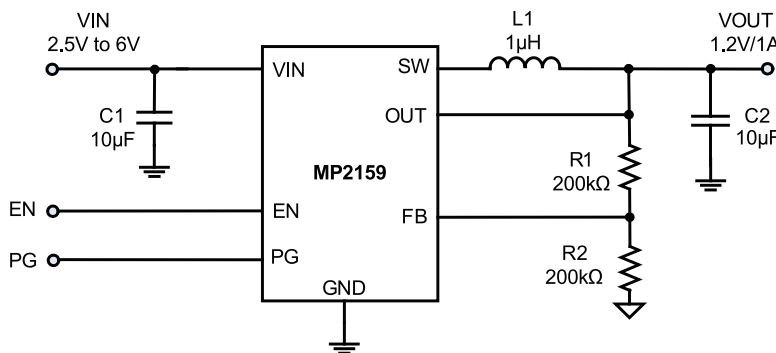

ORDERING INFORMATION

Part Number*	Package	Top Marking
MP2159GJ	TSOT23-8	AFE

* For Tape & Reel, add suffix -Z (e.g. MP2159GJ-Z);

PACKAGE REFERENCE

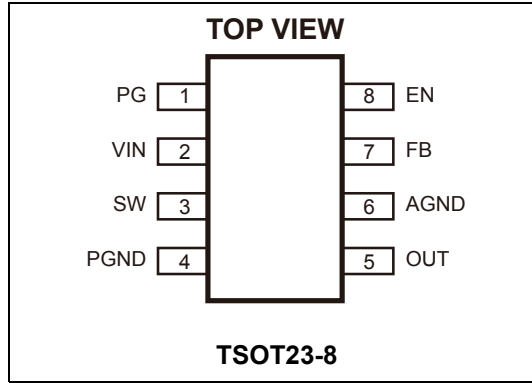

ABSOLUTE MAXIMUM RATINGS ⁽¹⁾

Supply Voltage V_{IN}	6.5V
V_{SW}	-0.3V (-1.5V for <10ns) to 6.5V (7V for <10ns)
All Other Pins	-0.3V to 6.5 V
Junction Temperature	150°C
Lead Temperature	260°C
Continuous Power Dissipation ($T_A = +25^\circ\text{C}$) ⁽²⁾	1.25W
Storage Temperature.....	-65°C to +150°C

Recommended Operating Conditions ⁽³⁾

Supply Voltage V_{IN}	2.5V to 6V
Operating Junction Temp. (T_J)	-40°C to +125°C

Thermal Resistance ⁽⁴⁾	θ_{JA}	θ_{JC}
TSOT23-8	100	55 ... °C/W

Notes:

- 1) Exceeding these ratings may damage the device.
- 2) The maximum allowable power dissipation is a function of the maximum junction temperature T_J (MAX), the junction-to-ambient thermal resistance θ_{JA} , and the ambient temperature T_A . The maximum allowable continuous power dissipation at any ambient temperature is calculated by P_D (MAX) = $(T_J$ (MAX)- T_A)/ θ_{JA} . Exceeding the maximum allowable power dissipation will cause excessive die temperature, and the regulator will go into thermal shutdown. Internal thermal shutdown circuitry protects the device from permanent damage.
- 3) The device is not guaranteed to function outside of its operating conditions.
- 4) Measured on JESD51-7, 4-layer PCB.

ELECTRICAL CHARACTERISTICS
V_{IN} = 5V, T_A = +25°C, unless otherwise noted.

Parameter	Symbol	Condition	Min	Typ	Max	Units
Feedback Voltage	V _{FB}	2.5V ≤ V _{IN} ≤ 6V	-3%	0.600	+3%	V/%
		T _A =-40°C to +85°C ⁽⁵⁾	-3.5%		+3.5%	
Feedback Current	I _{FB}	V _{FB} = 0.6V		10	50	nA
PFET Switch On Resistance	R _{DSON_P}			118		mΩ
NFET Switch On Resistance	R _{DSON_N}			88		mΩ
Switch Leakage		V _{EN} = 0V, V _{IN} = 6V V _{SW} = 0V and 6V		0	1	μA
PFET Current Limit				2		A
ON Time	T _{ON}	V _{IN} =5V, V _{OUT} =1.2V		185		ns
		V _{IN} =3.6V, V _{OUT} =1.2V		245		
Switching frequency	F _s	V _{OUT} =1.2V	-20%	1500	+20%	kHz/%
		T _A =-40°C to +85°C ⁽⁶⁾	-25%	1500	+25%	
Minimum Off Time	T _{MIN-OFF}			60		ns
Soft-Start Time	T _{SS-ON}			1.5		ms
Power Good Upper Trip Threshold	PG _H	FB voltage respect to the regulation		+10		%
Power Good Lower Trip Threshold	PG _L			-10		%
Power Good Delay	PG _D			50		μs
Power Good Sink Current Capability	V _{PG-L}	Sink 1mA			0.4	V
Power Good Logic High Voltage	V _{PG-H}	V _{IN} =5V, V _{FB} =0.6V	4.9			V
Power Good Internal Pull Up Resistor	R _{PG}			500		kΩ
Under Voltage Lockout Threshold Rising			2.15	2.3	2.45	V
Under Voltage Lockout Threshold Hysteresis				260		mV
EN Input Logic Low Voltage					0.4	V
EN Input Logic High Voltage			1.2			V
EN Input Current		V _{EN} =2V		1.5		μA
		V _{EN} =0V		0		μA
Supply Current (Shutdown)		V _{EN} =0V, V _{IN} =3V		20	100	nA
Supply Current (Quiescent)		V _{EN} =2V, V _{FB} =0.63V, V _{IN} =5V		17	20	μA
Thermal Shutdown ⁽⁶⁾				150		°C
Thermal Hysteresis ⁽⁶⁾				30		°C

Notes:

5) Guaranteed by characterization test.

6) Guaranteed by design.

TYPICAL PERFORMANCE CHARACTERISTICS

$V_{IN} = 5V$, $V_{OUT} = 1.2V$, $L = 1.0\mu H$, $T_A = +25^\circ C$, unless otherwise noted.

Quiescent Current vs. Input Voltage

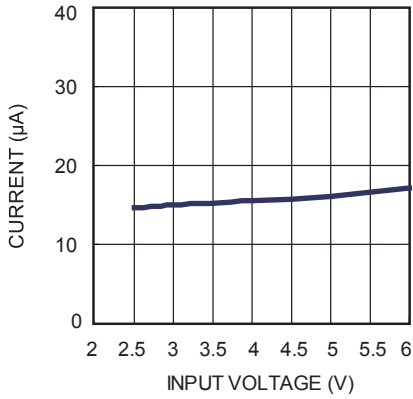

Shutdown Current vs. Input Voltage

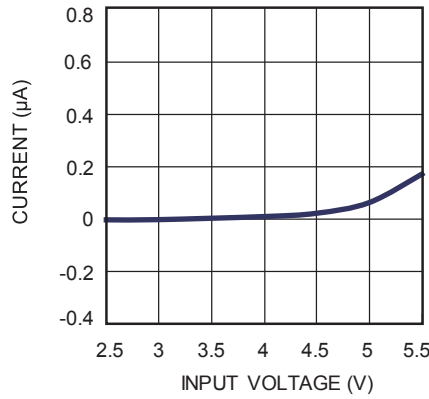

Load Regulation

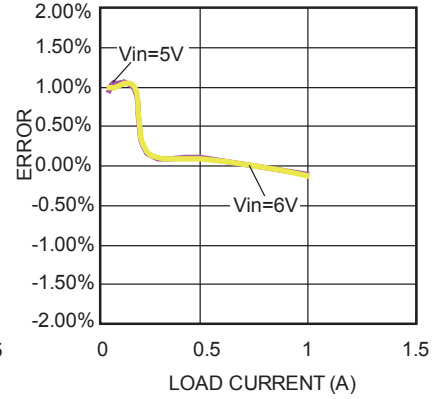

Line Regulation

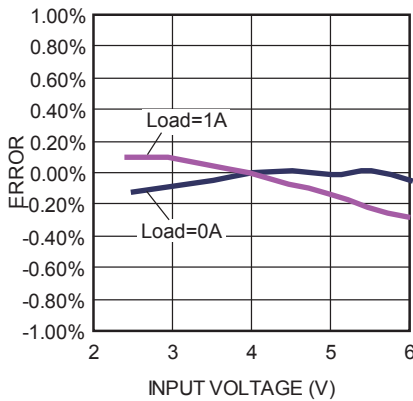

Case Temp Rise

$V_{in}=3V$, $V_o=1.2V$

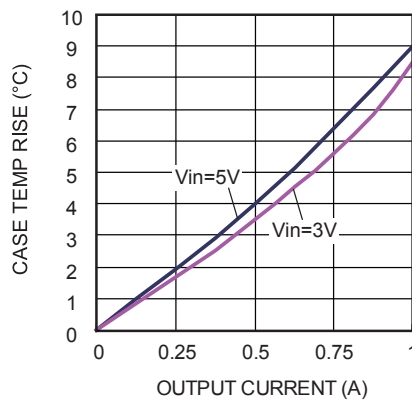

Case Temp Rise

$V_{in}=5V$, $V_o=3.3V$

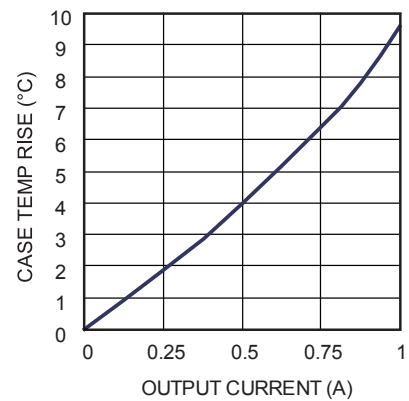

Efficiency

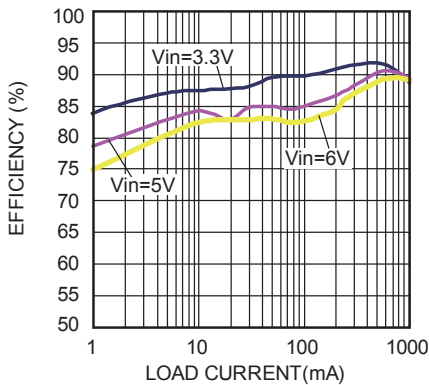

Efficiency

$5/3.3V_{IN}$ to $1.8V_{OUT}$

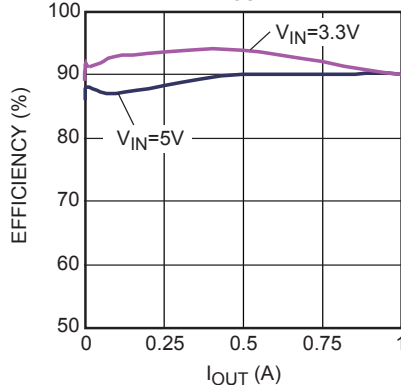

Efficiency

$5V_{IN}$ to $3.3V_{OUT}$

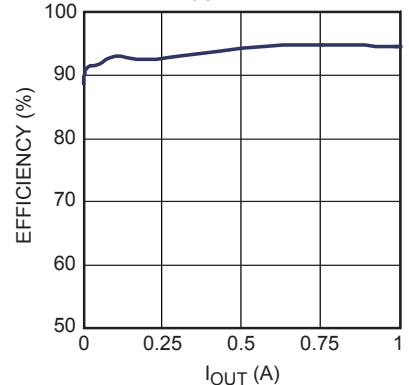

TYPICAL PERFORMANCE CHARACTERISTICS (continued)
 $V_{IN} = 5V, V_{OUT} = 1.2V, L = 1.0\mu H, T_A = +25^\circ C$, unless otherwise noted.

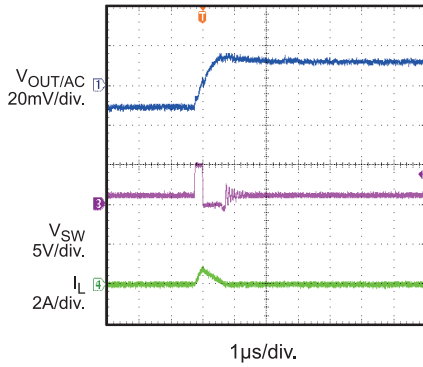
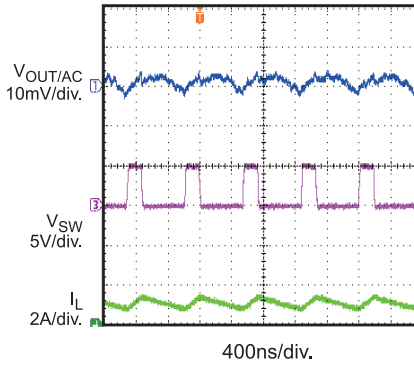
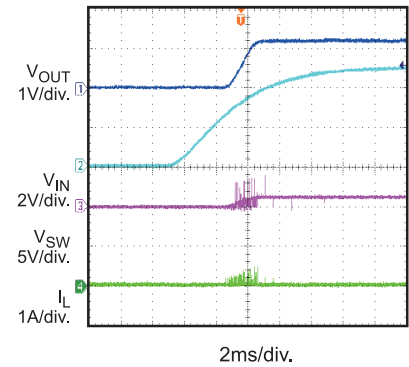
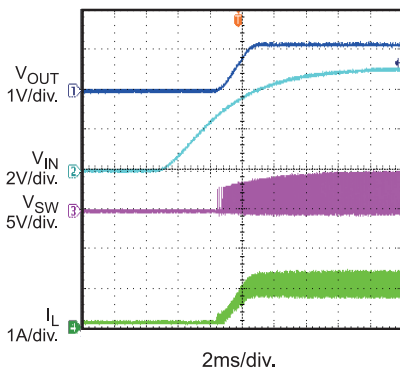
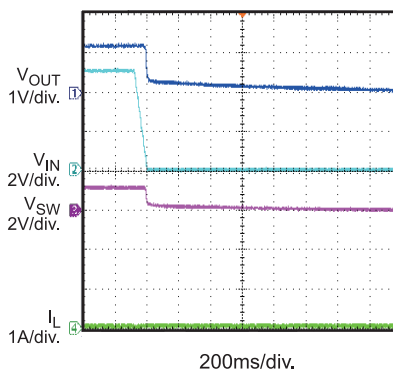
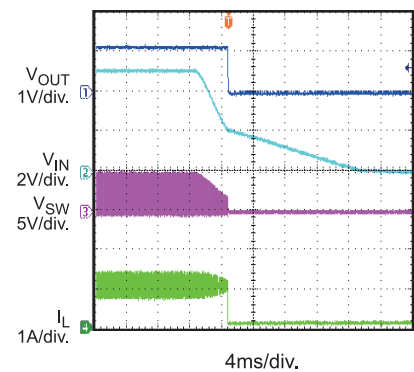
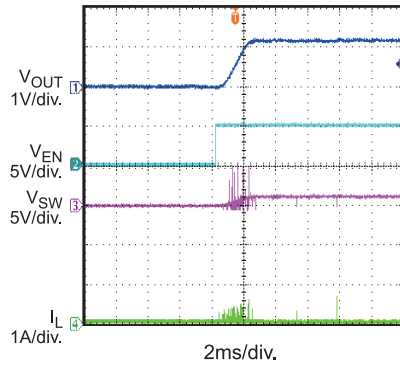
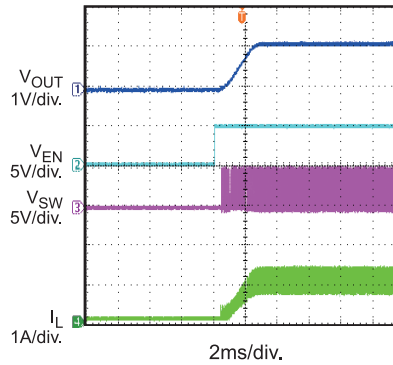
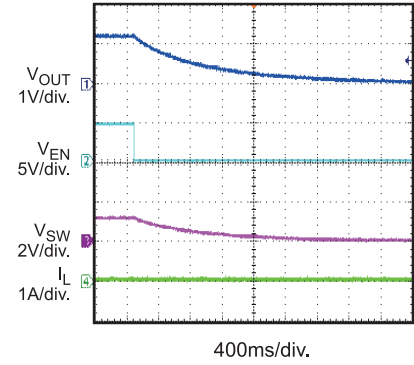
Output Ripple

Output Ripple

VIN Power Up without Load

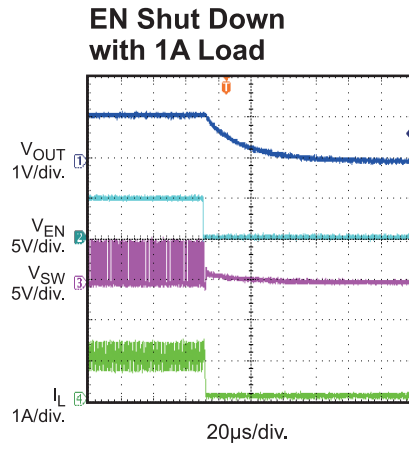
VIN Power Up with 1A Load

VIN Shut Down without Load

VIN Shut Down with 1A Load

EN Start Up without Load

EN Start Up with 1A Load

EN Shut Down without Load

TYPICAL PERFORMANCE CHARACTERISTICS (continued)

$V_{IN} = 5V$, $V_{OUT} = 1.2V$, $L = 1.0\mu H$, $T_A = +25^\circ C$, unless otherwise noted



PIN FUNCTIONS

TSOT23-8 Pin #	Name	Description
1	PG	Power Good Indicator. The output of this pin is an open drain with internal pull up resistor to VIN. PGOOD is pulled up to VIN when the FB voltage is within 10% of the regulation level, if FB voltage is out of that regulation range, it is LOW.
2	VIN	Supply Voltage. The MP2159 operates from a +2.5V to +6V unregulated input. C1 is needed to prevent large voltage spikes from appearing at the input.
3	SW	Switch Output
4	PGND	Power ground
5	OUT	Input sense pin for output voltage
6	AGND	Analogy ground for internal control circuit
7	FB	Feedback pin. An external resistor divider from the output to GND, tapped to the FB pin, sets the output voltage.
8	EN	On/Off Control

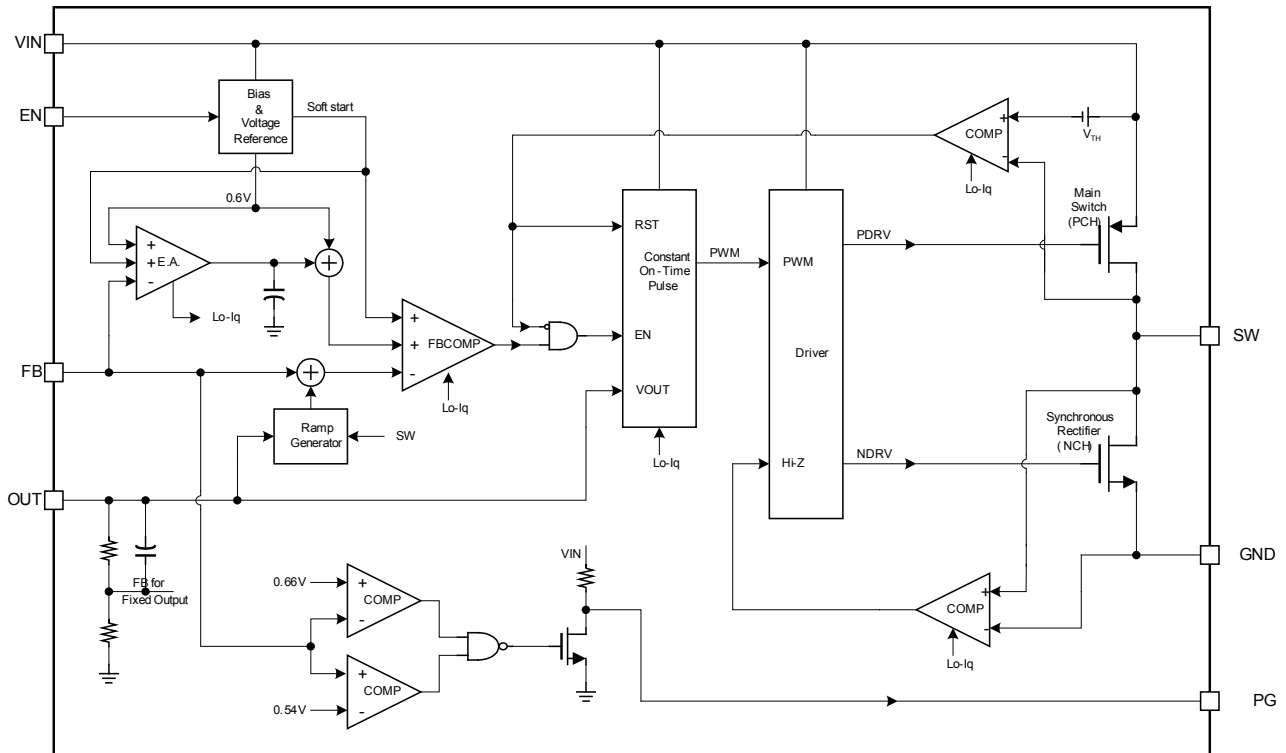
BLOCK DIAGRAM

Figure 1: MP2159 Block Diagram

OPERATION

MP2159 uses constant on-time control with input voltage feed forward to stabilize the switching frequency over full input range. At light load, MP2159 employs a proprietary control of low side switch and inductor current to eliminate ringing on switching node and improve efficiency.

Constant On-time Control

Compare to fixed frequency PWM control, constant on-time control offers the advantage of simpler control loop and faster transient response. By using input voltage feed forward, MP2159 maintains a nearly constant switching frequency across input and output voltage range. The on-time of the switching pulse can be estimated as:

$$T_{ON} = \frac{V_{OUT}}{V_{IN}} \cdot 0.667 \mu\text{s}$$

To prevent inductor current run away during load transient, MP2159 fixes the minimum off time to be 60ns. However, this minimum off time limit will not affect operation of MP2159 in steady state in any way.

Light Load Operation

In light load condition, MP2159 uses a proprietary control scheme to save power and improve efficiency. The MP2159 will turn off the low side switch when inductor current starts to reverse. Then MP2159 works in discontinuous conduction mode (DCM) operation.

The DCM mode happens only after low side switch turned off by ZCD circuit. Considering the ZCD circuit propagation time, the typical delay is 30ns. It means the inductor current still fall after the ZCD is trigger during this delay. If the inductor current falling slew rate is fast (V_o voltage is high or close to V_{in}), the low side MOSFET is turned off at the moment inductor current may be negative. This phenomena will cause MP2159 can not enter DCM operation. If the DCM mode is required, the off time of low side MOSFET in CCM should be longer than 60ns. It means the maximum duty is 90% to guarantee DCM mode at light load.

For example, V_{IN} is 3.4V and V_{OUT} is 3.3V, the off time in CCM is 20ns. It is difficult to enter

DCM at light load. And using smaller inductor can improve it and make it enter DCM easily.

Enable

When input voltage is greater than the under-voltage lockout threshold (UVLO), typically 2.3V, MP2159 can be enabled by pulling EN pin to higher than 1.2V. Leaving EN pin float or pull down to ground will disable MP2159. There is an internal 1Meg Ohm resistor from EN pin to ground.

Soft Start

MP2159 has built-in soft start that ramps up the output voltage in a controlled slew rate, avoiding overshoot at startup. The soft start time is about 1.5ms typical.

Power GOOD Indicator

MP2159 has an open drain with 500kΩ pull-up resistor pin for power good indicator PGOOD. When FB pin is within +/-10% of regulation voltage, i.e. 0.6V, PGOOD pin is pulled up to V_{IN} by the internal resistor. If FB pin voltage is out of the +/-10% window, PGOOD pin is pulled down to ground by an internal MOS FET. The MOS FET has a maximum R_{dson} of less than 100 Ohm.

Current limit

MP2159 has a typical 2A current limit for the high side switch. When the high side switch hits current limit, MP2159 will touch the hiccup threshold until the current lower down. This will prevent inductor current from continuing to build up which will result in damage of the components.

Short Circuit and Recovery

MP2159 enters short circuit protection mode also when the current limit is hit, and tries to recover from short circuit with hiccup mode. In short circuit protection, MP2159 will disable output power stage, discharge soft-start cap and then automatically try to soft-start again. If the short circuit condition still holds after soft-start ends, MP2159 repeats this operation cycle till short circuit disappears and output rises back to regulation level.

APPLICATION INFORMATION

COMPONENT SELECTION

Setting the Output Voltage

The external resistor divider is used to set the output voltage (see Typical Application on page 1). The feedback resistor R1 can not be too large neither too small considering the trade-off for stability and dynamic. Choose R1 to be around 120kΩ to 200kΩ. R2 is then given by:

$$R2 = \frac{R1}{\frac{V_{out}}{0.6} - 1}$$

The feedback circuit is shown as Figure 2.

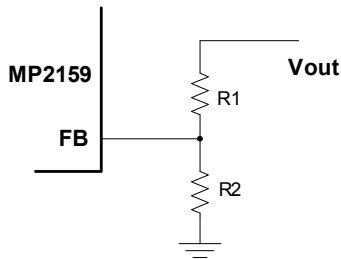

Figure 2: Feedback Network

Table 1 lists the recommended resistors value for common output voltages.

Table 1—Resistor Selection for Common Output Voltages

V _{OUT} (V)	R1 (kΩ)	R2 (kΩ)
1.0	200(1%)	300(1%)
1.2	200(1%)	200(1%)
1.8	200(1%)	100(1%)
2.5	200(1%)	63.2(1%)
3.3	200(1%)	44.2(1%)

Selecting the Inductor

A 0.68μH to 2.2μH inductor is recommended for most applications. For highest efficiency, the inductor DC resistance should be less than 15mΩ. For most designs, the inductance value can be derived from the following equation.

$$L_1 = \frac{V_{OUT} \times (V_{IN} - V_{OUT})}{V_{IN} \times \Delta I_L \times f_{OSC}}$$

Where ΔI_L is the inductor ripple current.

Choose inductor current to be approximately 30% of the maximum load current. The maximum inductor peak current is:

$$I_{L(MAX)} = I_{LOAD} + \frac{\Delta I_L}{2}$$

Selecting the Input Capacitor

The input current to the step-down converter is discontinuous, therefore a capacitor is required to supply the AC current to the step-down converter while maintaining the DC input voltage. Use low ESR capacitors for the best performance. Ceramic capacitors with X5R or X7R dielectrics are highly recommended because of their low ESR and small temperature coefficients. For most applications, a 10μF capacitor is sufficient. For higher output voltage, 22μF may be needed for more stable system.

Since the input capacitor absorbs the input switching current it requires an adequate ripple current rating. The RMS current in the input capacitor can be estimated by:

$$I_{C1} = I_{LOAD} \times \sqrt{\frac{V_{OUT}}{V_{IN}} \times \left(1 - \frac{V_{OUT}}{V_{IN}}\right)}$$

The worse case condition occurs at V_{IN} = 2V_{OUT}, where:

$$I_{C1} = \frac{I_{LOAD}}{2}$$

For simplification, choose the input capacitor whose RMS current rating greater than half of the maximum load current.

The input capacitor can be electrolytic, tantalum or ceramic. When using electrolytic or tantalum capacitors, a small and high quality ceramic capacitor, i.e. 0.1μF, should be placed as close to the IC as possible. When using ceramic capacitors, make sure that they have enough capacitance to provide sufficient charge to prevent excessive voltage ripple at input. The input voltage ripple caused by capacitance can be estimated by:

$$\Delta V_{IN} = \frac{I_{LOAD}}{f_s \times C1} \times \frac{V_{OUT}}{V_{IN}} \times \left(1 - \frac{V_{OUT}}{V_{IN}}\right)$$

Selecting the Output Capacitor

The output capacitor (C2) is required to maintain the DC output voltage. Ceramic capacitors are recommended. Low ESR capacitors are preferred to keep the output voltage ripple low. The output voltage ripple can be estimated by:

$$\Delta V_{OUT} = \frac{V_{OUT}}{f_s \times L_1} \times \left(1 - \frac{V_{OUT}}{V_{IN}}\right) \times \left(R_{ESR} + \frac{1}{8 \times f_s \times C2}\right)$$

Where L_1 is the inductor value and R_{ESR} is the equivalent series resistance (ESR) value of the output capacitor.

Using ceramic capacitors, the impedance at the switching frequency is dominated by the capacitance. The output voltage ripple is mainly caused by the capacitance. For simplification, the output voltage ripple can be estimated by:

$$\Delta V_{OUT} = \frac{V_{OUT}}{8 \times f_s^2 \times L_1 \times C2} \times \left(1 - \frac{V_{OUT}}{V_{IN}}\right)$$

In the case of tantalum or electrolytic capacitors, the ESR dominates the impedance at the switching frequency. For simplification, the output ripple can be approximated to:

$$\Delta V_{OUT} = \frac{V_{OUT}}{f_s \times L_1} \times \left(1 - \frac{V_{OUT}}{V_{IN}}\right) \times R_{ESR}$$

The characteristics of the output capacitor also affect the stability of the regulation system.

PCB Layout

Proper layout of the switching power supplies is very important, and sometimes critical for proper function. For the high-frequency switching converter, poor layout design can result in poor line or load regulation and stability issues.

The high current paths (GND, IN and SW) should be placed very close to the device with short, direct and wide traces. The input capacitor needs to be as close as possible to the IN and GND pins. The external feedback resistors should be placed next to the FB pin. Keep the switching node SW short and away from the feedback network.

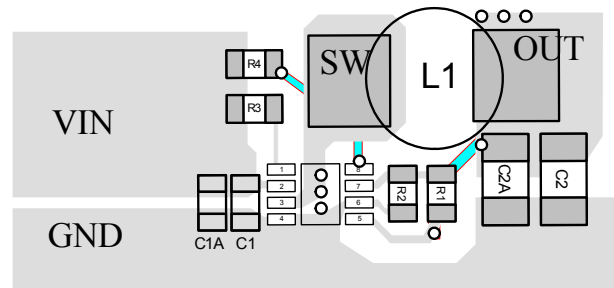

Figure 3: PCB Layout Recommendation

Design Example

Below is a design example following the application guidelines for the specifications:

Table 2: Design Example

V_{IN}	5V
V_{OUT}	1.2V
f_{sw}	1500kHz

The detailed application schematic is shown in Figure 4. The typical performance and circuit waveforms have been shown in the Typical Performance Characteristics section. For more device applications, please refer to the related Evaluation Board Datasheets.

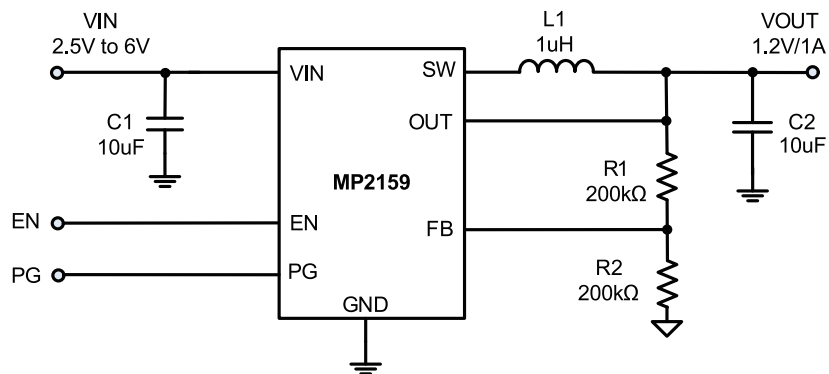
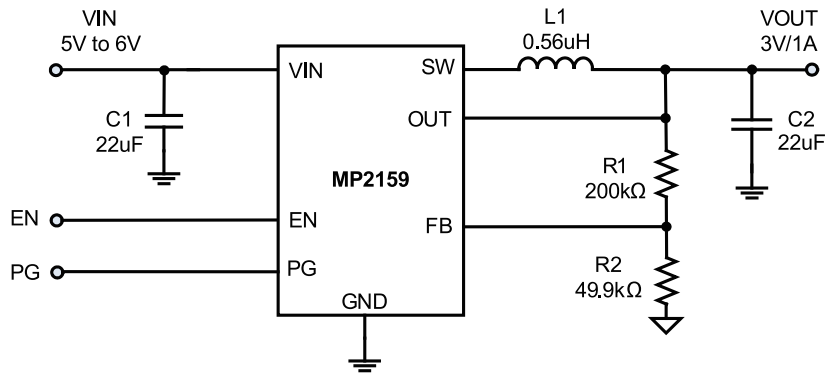
TYPICAL APPLICATION CIRCUITS

Figure 4: Typical Application Circuit

Figure 5: Typical Application Circuit for Higher efficiency at Light Load

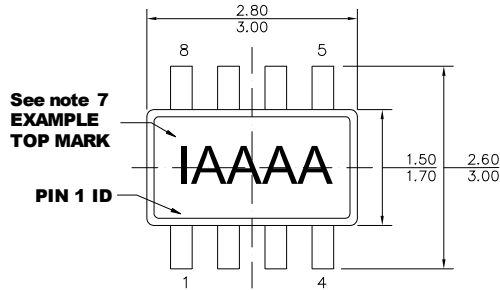
PACKAGE INFORMATION

TSOT23-8

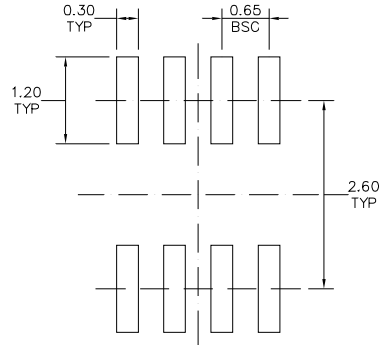

TOP VIEW



RECOMMENDED LAND PATTERN

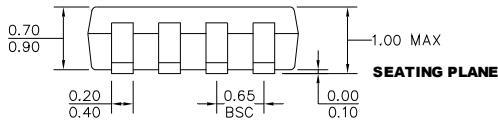

FRONT VIEW

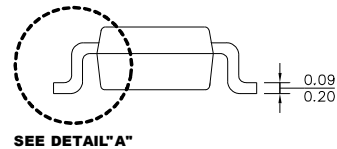

SIDE VIEW

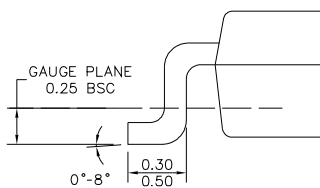

DETAIL "A"

NOTE:

- 1) ALL DIMENSIONS ARE IN MILLIMETERS
- 2) PACKAGE LENGTH DOES NOT INCLUDE MOLD FLASH PROTRUSION OR GATE BURR
- 3) PACKAGE WIDTH DOES NOT INCLUDE INTERLEAD FLASH OR PROTRUSION
- 4) LEAD COPLANARITY (BOTTOM OF LEADS AFTER FORMING) SHALL BE 0.10 MILLIMETERS MAX
- 5) JEDEC REFERENCE IS MO193, VARIATION BA
- 6) DRAWING IS NOT TO SCALE
- 7) PIN 1 IS LOWER LEFT PIN WHEN READING TOP MARK FROM LEFT TO RIGHT, (SEE EXAMPLE TOP MARK)

NOTICE: The information in this document is subject to change without notice. Please contact MPS for current specifications. Users should warrant and guarantee that third party Intellectual Property rights are not infringed upon when integrating MPS products into any application. MPS will not assume any legal responsibility for any said applications.

X-ON Electronics

Largest Supplier of Electrical and Electronic Components

Click to view similar products for [Switching Voltage Regulators](#) category:

Click to view products by [Monolithic Power Systems](#) manufacturer:

Other Similar products are found below :

[FAN53610AUC33X](#) [FAN53611AUC123X](#) [FAN48610BUC33X](#) [FAN48610BUC45X](#) [FAN48617UC50X](#) [R3](#) [430464BB](#) [KE177614](#)
[MAX809TTR](#) [NCV891234MW50R2G](#) [NCP81103MNTXG](#) [NCP81203PMNTXG](#) [NCP81208MNTXG](#) [NCP81109GMNTXG](#)
[SCY1751FCCT1G](#) [NCP81109JMNTXG](#) [AP3409ADNTR-G1](#) [NCP81241MNTXG](#) [LTM8064IY](#) [LT8315EFE#TRPBF](#) [NCV1077CSTBT3G](#)
[XCL207A123CR-G](#) [MPM54304GMN-0002](#) [MPM54304GMN-0003](#) [XDPE132G5CG000XUMA1](#) [DA9121-B0V76](#) [MP8757GL-P](#)
[MIC23356YFT-TR](#) [LD8116CGL](#) [HG2269M/TR](#) [OB2269](#) [XD3526](#) [U6215A](#) [U6215B](#) [U6620S](#) [LTC3803ES6#TR](#) [LTC3803ES6#TRM](#)
[LTC3412IFE](#) [LT1425IS](#) [MAX25203BATJA/VY+](#) [MAX77874CEWM+](#) [XC9236D08CER-G](#) [ISL95338IRTZ](#) [MP3416GJ-P](#) [BD9S201NUX-](#)
[CE2](#) [MP5461GC-Z](#) [MPQ4415AGQB-Z](#) [MPQ4590GS-Z](#) [MCP1603-330IMC](#) [MCP1642B-18IMC](#)