

DESCRIPTION

The MP2410 is a 24V, monolithic, synchronous, step-down, white LED driver with a built-in power MOSFET and rectifier. It achieves up to 2A of continuous output current with excellent load and line regulation. Peak current mode operation provides fast transient response and eases loop stabilization.

The MP2410 implements deep analog dimming. Full protection features include cycle-by-cycle peak-current limiting, output short-circuit protection (SCP), open LED protection, NTC thermal protection, and thermal shutdown.

The MP2410 requires a minimum number of readily available, standard, external components and is available in TSOT23-6 and TSOT23-8 packages.

FEATURES

- 4.2V to 24V Wide Input Range
- Synchronous Step-Down Converter
- 100mΩ Internal High-Side Power MOSFET
- 80mΩ Internal Low-Side Synchronous Rectifier
- Peak Current Mode Control
- Up to 2A Continuous Output Current
- 100mV Feedback Voltage
- Up to 97% Efficiency
- Fixed 1MHz Switching Frequency
- Analog Dimming
- Cycle-by-Cycle Current Limit
- Inherent LED Open Protection
- Output Short-Circuit Protection (SCP)
- NTC Thermal Protection
- Thermal Shutdown
- Auto-Restart Function
- Available in TSOT23-6 and TSOT23-8 Packages

APPLICATIONS

- Infrared LED Driver
- General LED Driver
- Flashlight
- Handheld Computers Backlight

All MPS parts are lead-free, halogen-free, and adhere to the RoHS directive. For MPS green status, please visit the MPS website under Quality Assurance. "MPS" and "The Future of Analog IC Technology" are registered trademarks of Monolithic Power Systems, Inc.

TYPICAL APPLICATION

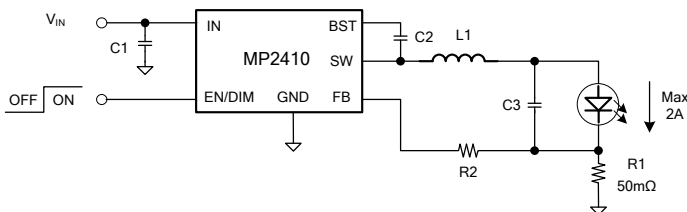

Efficiency vs. VIN

V_{IN}=12V, 2 WLEDs in series, V_{OUT}=5.9V,
T_A = 25°C

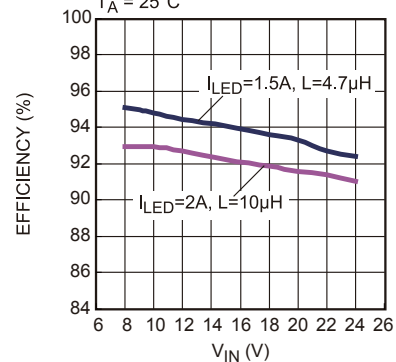

ORDERING INFORMATION

Part Number	Package	Top Marking
MP2410GJ*	TSOT23-6	<i>See Below</i>
MP2410GJE**	TSOT23-8	

* For Tape & Reel, add suffix -Z (e.g. MP2410GJ-Z)

** For Tape & Reel, add suffix -Z (e.g. MP2410GJE-Z)

TOP MARKING (TSOT23-6)

|ALGY

ALG: Product code of MP2410GJ

Y: Year code

TOP MARKING (TSOT23-8)

|ALXY

ALX: Product code of MP2410GJE

Y: Year code

PACKAGE REFERENCE

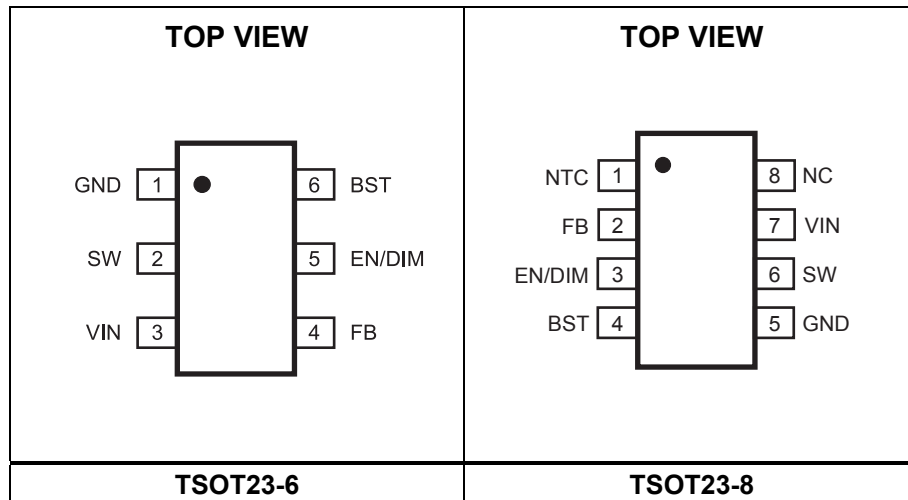

ABSOLUTE MAXIMUM RATINGS ⁽¹⁾

Supply voltage (V_{IN})	26V
V_{SW}	-0.3V to $V_{IN} + 0.3V$
V_{BST}	$V_{SW} + 6V$
All other pins	-0.3V to +6V
Continuous power dissipation ($T_A = 25^\circ C$) ⁽²⁾	
TSOT23-6	1.25W
TSOT23-8	1.25W
Junction temperature	150°C
Lead temperature	260°C
Storage temperature	-65°C to +150°C
ESD capability human body mode	2.0kV

Recommended Operating Conditions ⁽³⁾

Supply voltage (V_{IN})	4.2V to 24V
Operating junction temp. (T_J)	-40°C to 125°C

Thermal Resistance ⁽⁴⁾

	θ_{JA}	θ_{JC}
TSOT23-6	100	55 ... °C/W
TSOT23-8	100	55 ... °C/W

NOTES:

- 1) Exceeding these ratings may damage the device.
- 2) The maximum allowable power dissipation is a function of the maximum junction temperature T_J (MAX), the junction-to-ambient thermal resistance θ_{JA} , and the ambient temperature T_A . The maximum allowable continuous power dissipation at any ambient temperature is calculated by P_D (MAX) = $(T_J$ (MAX) - T_A) / θ_{JA} . Exceeding the maximum allowable power dissipation produces an excessive die temperature, causing the regulator to go into thermal shutdown. Internal thermal shutdown circuitry protects the device from permanent damage.
- 3) The device is not guaranteed to function outside of its operating conditions.
- 4) Measured on JESD51-7, 4-layer PCB.

ELECTRICAL CHARACTERISTICS

Typical values are $V_{IN} = 12V$, $T_J = 25^{\circ}C$, unless otherwise noted. Minimum and maximum values are at $V_{IN} = 12V$, $T_J = -40^{\circ}C$ to $+125^{\circ}C$, unless otherwise noted, guaranteed by characterization.

Parameters	Symbol	Condition	Min	Typ	Max	Units
Supply Voltage						
Operating range	V_{IN}	After turn on	4.2		24	V
Turn on threshold	$V_{IN\ ON}$	V_{IN} rising edge	3.5	3.7	4	V
Hysteretic voltage	$V_{IN\ HYS}$			0.12		V
Supply Current						
Shutdown current	I_{SD}	$V_{EN} = 0V$		10	50	μA
Quiescent current	I_Q	$V_{EN} = 2V$, $V_{FB} = 200mV$		0.9	1.1	mA
Enable and Dimming (EN/DIM)						
EN/DIM off threshold	$V_{EN\ OFF}$	$V_{EN/DIM}$ falling edge	0.27	0.31	0.35	V
EN/DIM on threshold	$V_{EN\ ON}$	$V_{EN/DIM}$ rising edge	0.545	0.59	0.635	V
Turn off delay time	$t_{OFF\ DELAY}$		16	22	28	ms
EN/DIM pull-up current	$I_{EN/DIM}$	$V_{EN} = 0V$	2.8	3.8	5.3	μA
Max analog dimming threshold	$V_{ADIM\ MAX}$	Theoretically, $V_{FB} = 100mV$	1.31	1.44	1.57	V
Min analog dimming threshold	$V_{ADIM\ MIN}$	$V_{FB} = 5mV$	0.63	0.7	0.78	V
Feedback (FB)						
Feedback voltage	V_{FB}	$4.2V \leq V_{IN} \leq 24V$	93	100	107	mV
Feedback current	I_{FB}	$V_{FB} = 150mV$		30	75	nA
Power Switch						
High-side MOSFET on resistance	$R_{DS(ON)_H}$	$V_{IN} = 5.0V$		100	170	m Ω
		$V_{IN} = 4.2V$		110	180	m Ω
Low-side synchronous rectifier switch on resistance	$R_{DS(ON)_L}$	$V_{IN} = 5.0V$		80	140	m Ω
		$V_{IN} = 4.2V$		90	150	m Ω
Switch leakage	$I_{SW\ LKG}$	$V_{EN} = 0V$, $V_{SW} = 0V$			1	μA
High-side current limit	I_{LIMIT_H}	When high-side switch turns on	3.5	5	6.6	A
Low-side current limit	I_{LIMIT_L}	When low-side switch turns on	-890	-630	-330	mA
OCP current threshold	I_{OCP}	Both for high-side and low-side	3.6	5.5	7	A
Oscillator frequency	f_{SW}	$V_{FB} = 80mV$	0.8	1	1.2	MHz
Maximum duty cycle	D_{MAX}	$V_{FB} = 80mV$	90	94		%
Minimum on time	$t_{ON\ MIN}$			70		ns
Restart Timer						
Hiccup timer at fault condition	t_{START}			2.4		ms

ELECTRICAL CHARACTERISTICS (continued)

Typical values are $V_{IN} = 12V$, $T_J = 25^{\circ}C$, unless otherwise noted. Minimum and maximum values are at $V_{IN} = 12V$, $T_J = -40^{\circ}C$ to $+125^{\circ}C$, unless otherwise noted, guaranteed by characterization.

Parameters	Symbol	Condition	Min	Typ	Max	Units
Bootstrap						
Bias voltage for high-side driver	$V_{BST-V_{SW}}$	$5.5V \leq V_{IN} \leq 24V$	4.8	5.1	5.5	V
		$V_{IN} = 4.2V$	3.6			V
NTC						
High-threshold voltage	$V_{H\ NTC}$	$V_{FB} = 95mV$	1.16	1.25	1.34	V
Low-threshold voltage	$V_{L\ NTC}$	$V_{FB} = 5mV$	0.76	0.82	0.88	V
Shutdown threshold	$V_{SD\ NTC}$	V_{NTC} falling edge	0.34	0.41	0.47	V
Shutdown voltage hysteresis	$V_{SD\ NTC\ HYS}$		55	110	185	mV
Pull-up current source	$I_{PULL\ UP\ NTC}$		41	58	72	μA
Leakage current	$I_{NTC\ LKG}$				1	μA
Thermal Shutdown						
Thermal shutdown threshold ⁽⁵⁾	T_{SD}			150		$^{\circ}C$
Thermal shutdown hysteresis ⁽⁵⁾	T_{HYS}			60		$^{\circ}C$

NOTE:

5) Guaranteed by characterization.

TYPICAL PERFORMANCE CHARACTERISTICS

Feedback Voltage vs. Junction Temperature

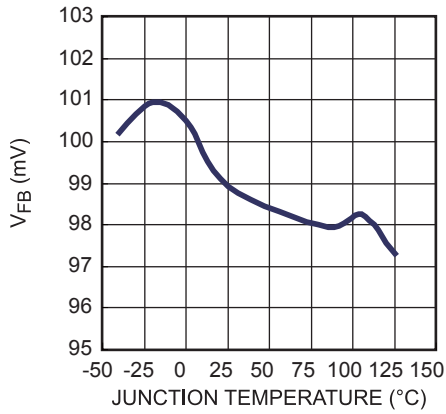

High-Side MOSFET On Resistance vs. Junction Temperature

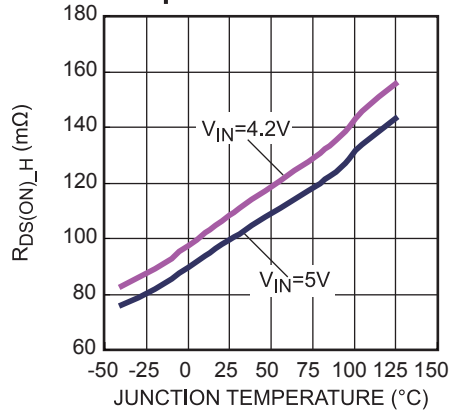

Low-Side Rectifier On Resistance vs. Junction Temperature

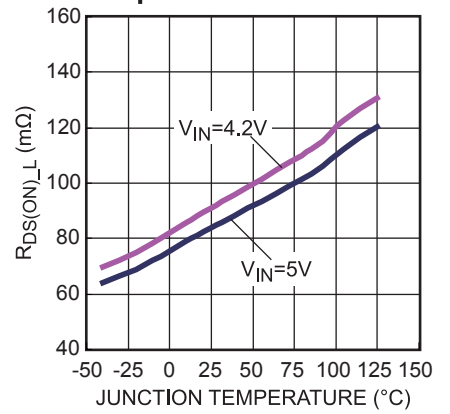

TYPICAL PERFORMANCE CHARACTERISTICS (continued)

Performance waveforms are tested on the evaluation board.

$V_{IN} = 12V$, 2 WLEDs in series, $V_{OUT} = 5.9V$, $I_{LED} = 1.5A$, $L = 4.7\mu H$, $T_A = 25^\circ C$, unless otherwise noted.

Efficiency vs. V_{IN}

2 WLEDs in series

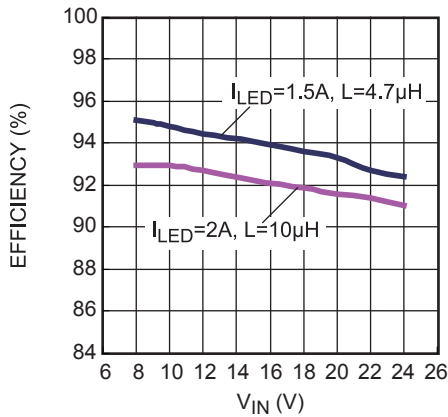

Efficiency vs. V_{OUT}

1 to 7 IR LEDs in series,
 $I_{LED}=500mA, L=22\mu H$

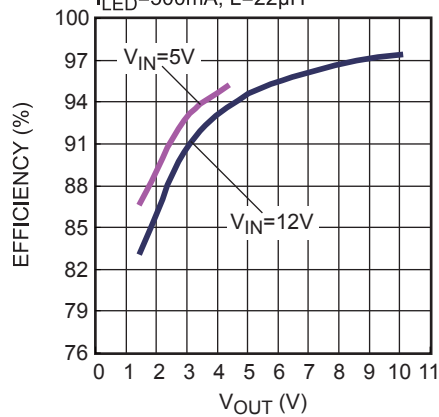

Line Regulation

2 WLEDs in series

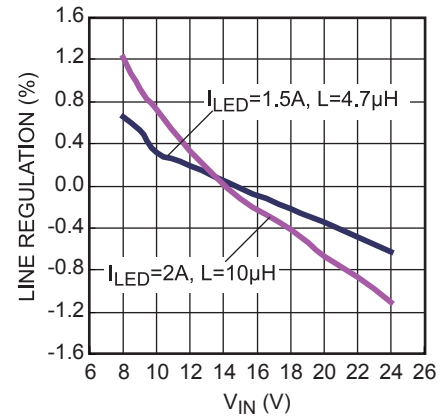

Load Regulation

1 to 7 IR LEDs in series,
 $I_{LED}=500mA, L=22\mu H$

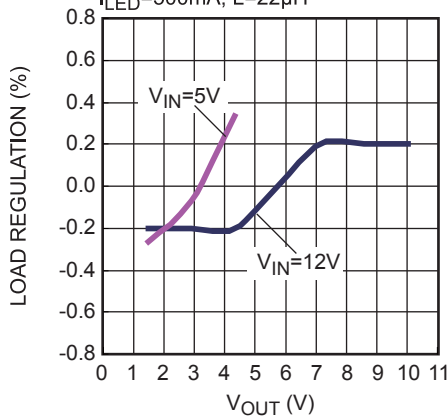

Analog Dimming Curve

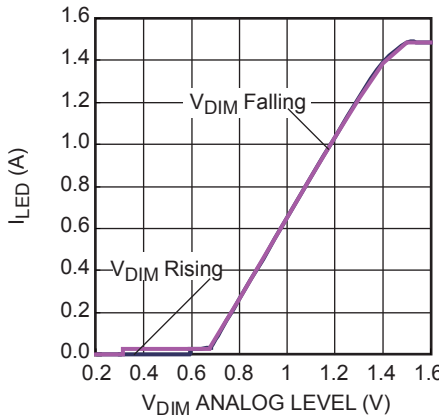

NTC Curve

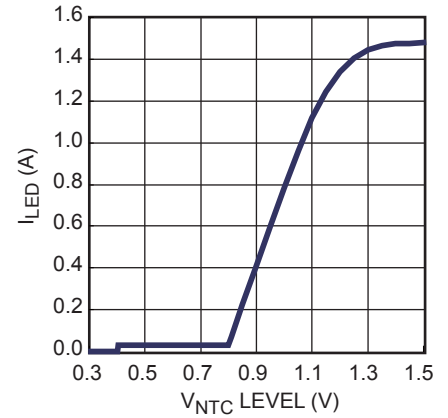

TYPICAL PERFORMANCE CHARACTERISTICS (continued)

Performance waveforms are tested on the evaluation board.

$V_{IN} = 12V$, 2 WLEDs in series, $V_{OUT} = 5.9V$, $I_{LED} = 1.5A$, $L = 4.7\mu H$, $T_A = 25^\circ C$, unless otherwise noted.

Steady State

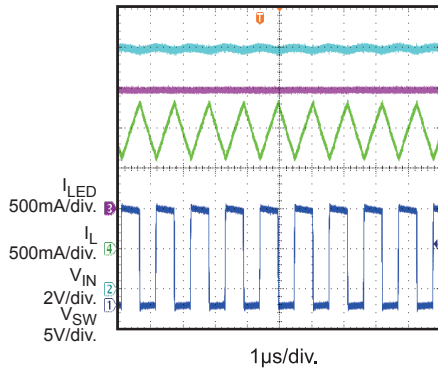

V_{IN} Start-Up

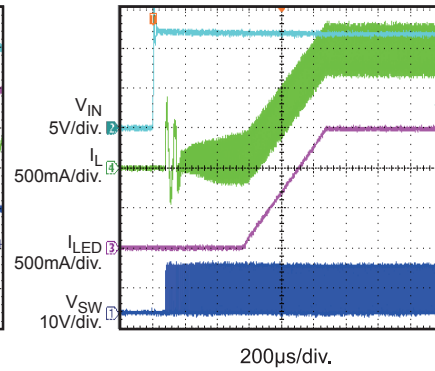

V_{IN} Shutdown

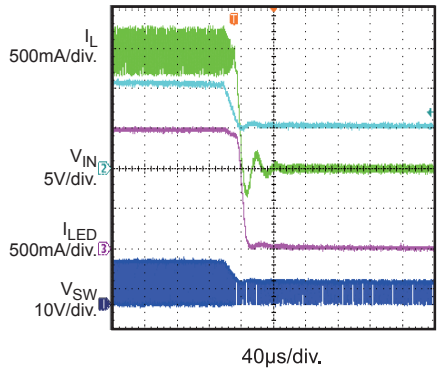

EN Start-Up

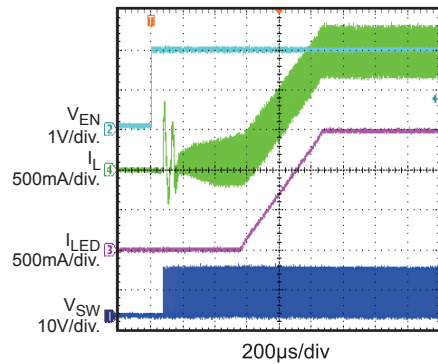

EN Shutdown

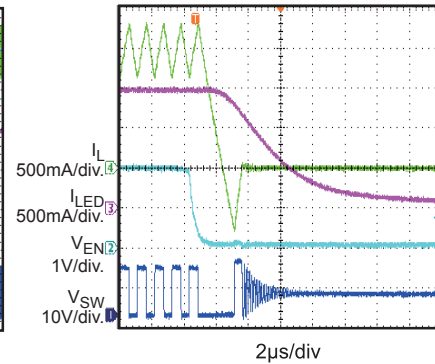

Minimum Analog Dimming

$V_{EN/DIM} = 0.6V$

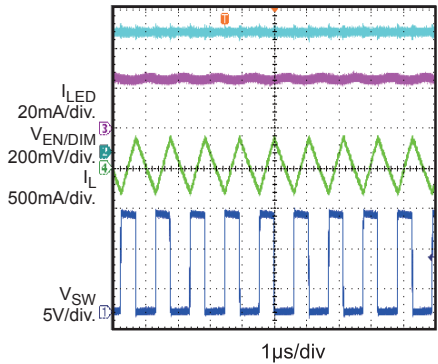

Open LED Protection

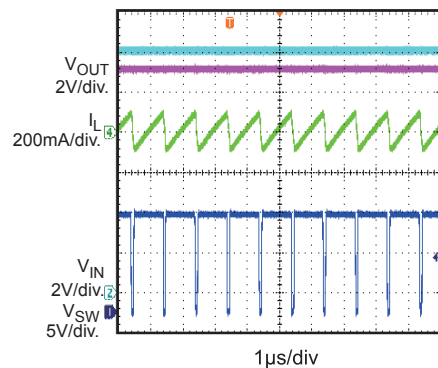

Short LED+ to LED- Protection

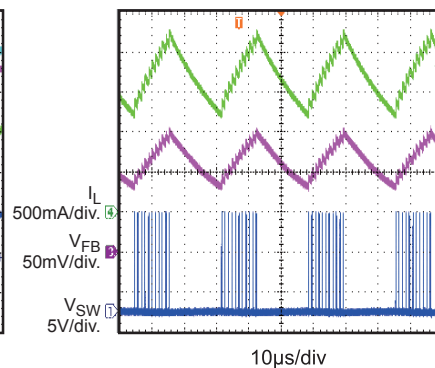

Short LED+ to GND Protection

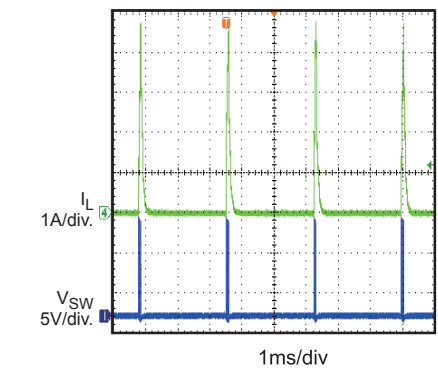

PIN FUNCTIONS

Pin #		Name	Description
TSOT23-6	TSOT23-8		
1	5	GND	Ground. GND is the voltage reference for the regulated output voltage. Give careful consideration to GND during layout.
2	6	SW	Switch output.
3	7	VIN	Supply voltage. The MP2410 operates on a 4.2V to 24V, unregulated input. An input capacitor is needed to prevent large voltage spikes from appearing at the input.
4	2	FB	Current sense feedback voltage. FB's internal reference voltage is 0.1V.
5	3	EN/DIM	On/off control input and dimming command input. Leaving EN/DIM floating or applying a voltage higher than 0.59V on EN/DIM turns on the MP2410. For analog dimming, when the EN/DIM voltage rises up from 0.7V to 1.44V, the output current changes from its min value to the full-scale LED current.
6	4	BST	Bootstrap. Connect a capacitor between SW and BST to form a floating supply across the power switch driver. This capacitor is needed to drive the power switch's gate above the supply voltage.
-	1	NTC	LED temperature protection. Connect an NTC resistor from NTC to GND to reduce the output current to protect the LED when the ambient temperature rises up at high levels.
-	8	NC	No connection.

BLOCK DIAGRAM

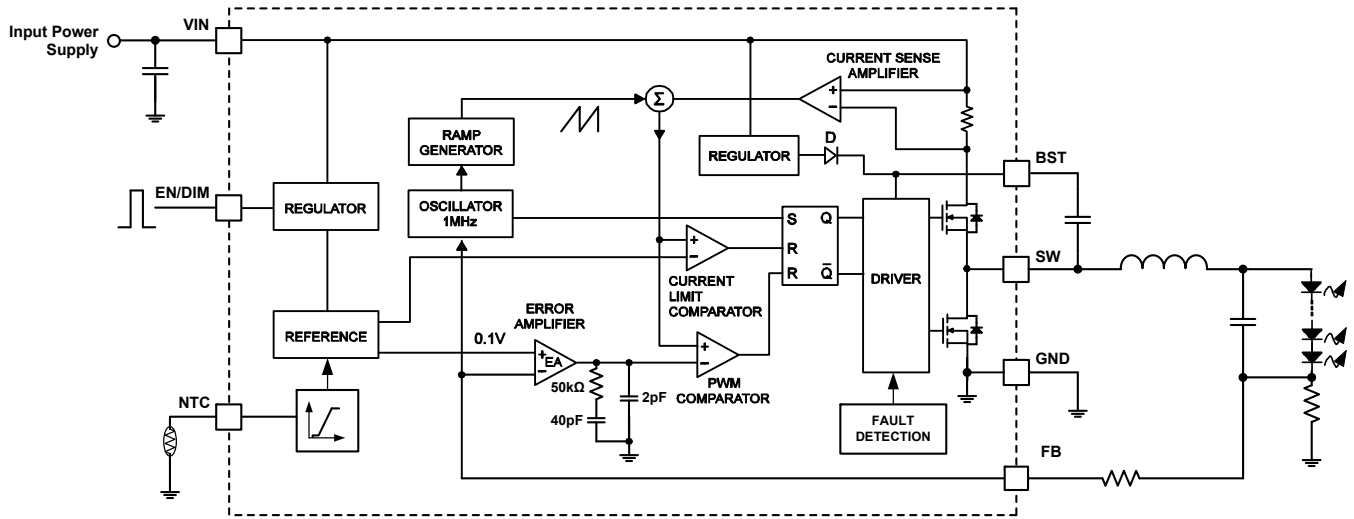

Figure 1: Functional Block Diagram

OPERATION

The MP2410 is a high-frequency, synchronous, rectified, step-down, switching mode LED driver with a built-in, internal power MOSFET and synchronous rectifier switch. The MP2410 offers a very high-performance solution that achieves up to 2A of continuous output LED current with excellent load and line regulation over a wide input supply range.

The MP2410 operates in a fixed 1MHz frequency and uses peak current control mode to regulate the output current. A new switching cycle is initiated by the internal clock at the beginning of every switching cycle.

The integrated high-side power MOSFET is turned on, and the inductor current rises linearly to provide energy to the load. The high-side power MOSFET remains on until its current reaches the value of the COMP level, which is the output of the internal error amplifier. The output voltage of the error amplifier depends on the difference of the output feedback and the internal, high-precision reference.

The high-side power switch remains off until the next clock cycle begins. After the high-side switch turns off, the low-side sync switch turns on, and the inductor current flows through the low-side switch. To prevent a shoot-through, a dead time is implemented to prevent the high-side and low-side FETs from turning on at the same time.

When the duty cycle of one switching period reaches 94%, the current in the high-side power MOSFET cannot reach the COMP-set current value, and the high-side power MOSFET is forced to turn off.

Under-Voltage Lockout (UVLO) and IC Start-Up/Shutdown Procedure

Under-voltage lockout (UVLO) is implemented to prevent the chip from operating at an insufficient supply voltage. The MP2410 UVLO comparator monitors the output voltage of the internal regulator, which is supplied from V_{IN} .

If both V_{IN} and EN/DIM are higher than their appropriate thresholds, the chip starts up. The reference block starts first to generate stable reference voltages and currents. The internal

regulator is then enabled. The regulator provides a stable supply for the remaining circuitries.

Three events can shut down the chip: EN/DIM low for longer than t_{OFF_DELAY} , V_{IN} drops below UVLO, and thermal shutdown. In the shutdown procedure, the signaling path is blocked first to prevent any fault triggering. The COMP voltage (V_{COMP}) and the internal supply rail are then pulled down.

Error Amplifier (EA)

The internal, low, offset error amplifier compares the FB voltage with the internal 100mV reference and outputs a COMP voltage, which is inside of the chip and is used to control the high-side MOSFET peak current and regulate the output current.

Internal Soft Start (SS)

A soft start (SS) is implemented to prevent the converter output current from overshooting during start-up. When the chip starts, the internal circuitry generates a soft-start voltage that ramps up from 0V. The soft-start period lasts until the voltage on the soft-start capacitor exceeds the 0.1V reference voltage. At this point, the reference voltage takes over.

Floating Driver and Bootstrap Charging

The high-side, floating, power MOSFET driver is powered by an external bootstrap capacitor. The bootstrap capacitor voltage is regulated internally. During normal operation, a 5.1V bootstrap voltage is maintained between BST and SW.

Enable and Dimming Control (EN/DIM)

EN/DIM is a control pin that turns the regulator on and off and dims the output LED current through a DC signal. Leave EN/DIM floating or drive it high to turn on the MP2410. After EN/DIM is pulled low for t_{OFF_DELAY} (22ms, typically), the MP2410 is turned off. Figure 2 shows the control logic of EN/DIM.

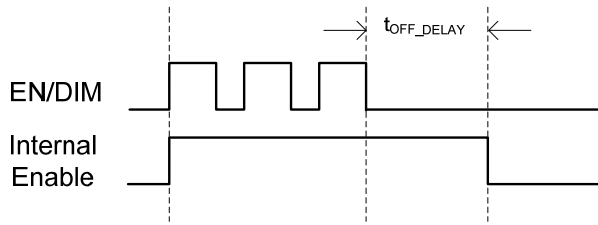
Figure 2: EN/DIM Time Sequence

Analog Dimming

Apply a DC signal on EN/DIM to dim the MP2410 in analog dimming mode. When the voltage on EN/DIM is lower than V_{ADIM_MIN} , the LED current is regulated to the minimal scale. When the voltage on EN/DIM is between V_{ADIM_MIN} and V_{ADIM_MAX} , the LED current changes from the minimal scale to the full scale of the LED current. If the voltage on EN/DIM is higher than V_{ADIM_MAX} , the maximum LED current is regulated.

Figure 3 shows the analog dimming curve. Due to the hysteresis of the EN/DIM on/off threshold, the chip remains at the minimal LED current longer at the $V_{EN/DIM}$ falling edge until $V_{EN/DIM}$ is lower than V_{EN_OFF} . The dimming curve is the same in the linear dimming range.

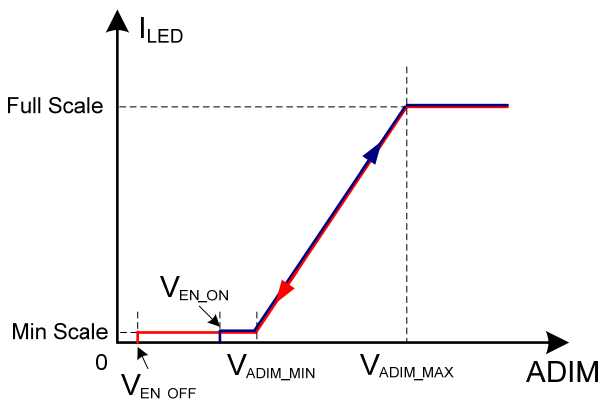
Figure 3: Analog Dimming Curve

Open LED

If the LED is open without a feedback signal, the MP2410 works at the maximum duty cycle, and the output voltage rises up close to the input voltage. Every power component operates at a safe state.

LED Short-Circuit Protection (SCP)

The MP2410 integrates LED short-circuit protection (SCP) circuitry. There are several features protecting the MP2410 from damage when an LED short circuit occurs.

The MP2410 features a cycle-by-cycle current limit to restrict the maximum current of the inductor. A protection mechanism monitors the FB level through an internal R-C filter. Once the FB level rises up to reach $V_{FB_BURST_AL}$, the chip stops switching until the FB level drops to a lower value, and the system works in burst mode.

In the worst-case scenario, the LED is shorted to GND. If the cycle-by-cycle current-limit function cannot clamp the current overshoot sufficiently, then the current through both the high-side and low-side FETs is also monitored by over-current detector inside the chip. If this current is higher than the short-circuit threshold (I_{OCP}), the MP2410 treats this as a short-circuit condition.

When an over-current condition or short-circuit condition is detected, the MP2410 turns off both the high-side and low-side MOSFETs for 2.4ms and restarts. During this period, V_{COMP} is pulled down to ground, so the restart from the fault condition is also done with a soft start.

Thermal Protection

NTC provides LED thermal protection. An NTC resistor used to monitor the ambient temperature can be connected to NTC directly. There is an internal current source flowing out of NTC. The corresponding voltage is generated on the external NTC resistor and the LED current changes (see Figure 4).

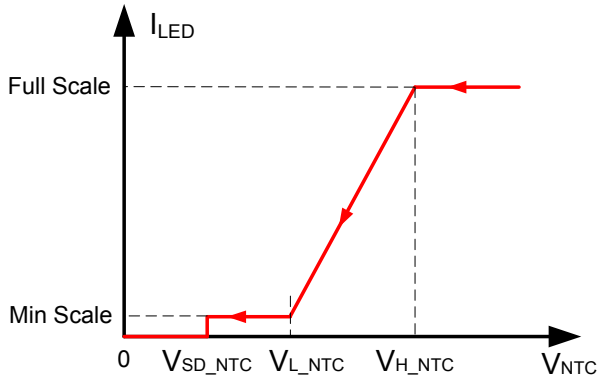

Figure 4: NTC Curve

The NTC resistance value drops when the ambient temperature rises up. If the NTC voltage drops below V_{SD_NTC} , the switching stops completely, and the LED current drops to 0A, so the LED lamp can be shut down by pulling NTC down.

Additionally, to protect against any lethal thermal damage, when the inner temperature exceeds the OTP threshold, the MP2410 shuts down the switching cycle with thermal shutdown until the temperature drops to its lower threshold.

Thermal Shutdown

Thermal shutdown is implemented to prevent the chip from operating at exceedingly high temperatures. When the silicon die temperature is higher than 150°C, OTP shuts down the entire chip. When the temperature is below its lower threshold (typically 90°C), the chip restarts.

APPLICATION INFORMATION

Setting the LED Current

A current sense resistor is inserted between the anode of LED and GND. The current sense resistor value can be calculated with Equation (1):

$$R_S = \frac{0.1V}{I_{LED}} \quad (1)$$

For 2A LED current output, choose $R_S = 50m\Omega$.

Selecting the Inductor

An inductor less than $100\mu H$ with a nominal DC current rating at least 25% higher than the maximum load current is recommended for most applications. For the highest efficiency, the inductor's DC resistance should be less than $100m\Omega$. For most designs, the required inductance value can be derived from Equation (2):

$$L = \frac{V_{OUT} \times (V_{IN} - V_{OUT})}{V_{IN} \times \Delta I_L \times f_{SW}} \quad (2)$$

Where ΔI_L is the inductor ripple current.

Choose the inductor ripple current to be 30% of the maximum load current. The maximum inductor peak current can be calculated with Equation (3):

$$I_{L(MAX)} = I_{LED} + \frac{\Delta I_L}{2} \quad (3)$$

Selecting the Input Capacitor

The input capacitor reduces the surge current drawn from the input supply and the switching noise from the device. The input capacitor impedance at the switching frequency should be less than the source impedance to prevent the high-frequency switching current from passing through the input. Ceramic capacitors with X5R or X7R dielectrics are highly recommended because of their low ESR and small temperature coefficients. For most applications, a $10\mu F$ capacitor is sufficient.

Selecting the Output Capacitor

The output capacitor keeps the output current ripple small and ensures feedback loop stability. The output capacitor impedance should be low at the switching frequency. Ceramic capacitors with X5R or X7R dielectrics are recommended for their low ESR characteristics. For most applications, a $10\mu F$ ceramic capacitor is sufficient.

PCB Layout Guidelines

Efficient PCB layout is critical for stable operation. For best results, refer to the guidelines below.

1. Place the high current paths (GND, V_{IN} , and SW) very close to the device with short, direct, and wide traces.
2. Place the input capacitor as close to IN and GND as possible.
3. Place the external feedback resistors next to FB.
4. Keep the switch node traces short and away from the feedback network.

For more information, please refer to the related evaluation board datasheet.

TYPICAL APPLICATION CIRCUIT

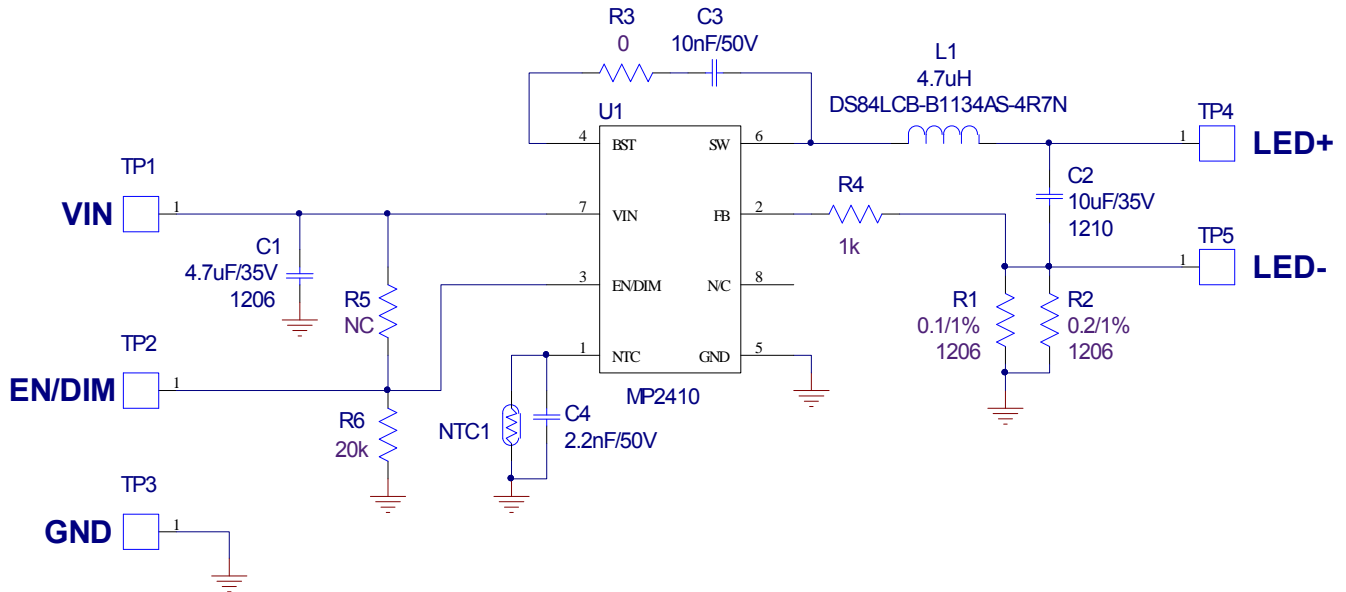
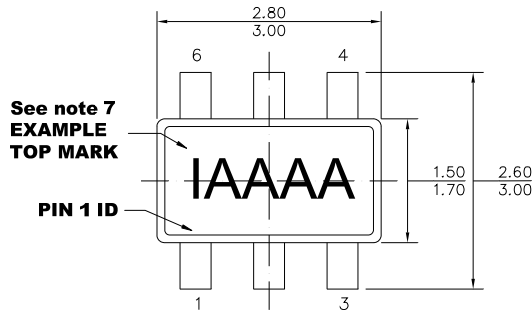

Figure 5: Typical Buck Converter Application, $V_{IN} = 8V$ to $24V$, $V_O = 5.9V$, $I_{LED} = 1.5A$

PACKAGE INFORMATION

TSOT23-6



TOP VIEW

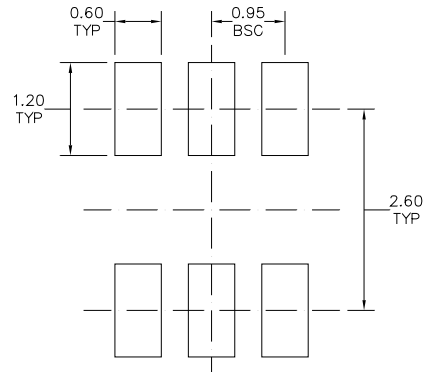

RECOMMENDED LAND PATTERN

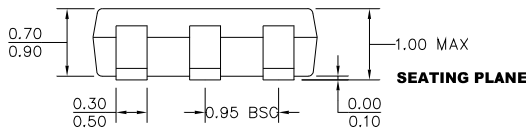

FRONT VIEW

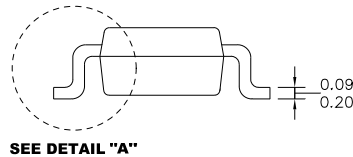

SIDE VIEW

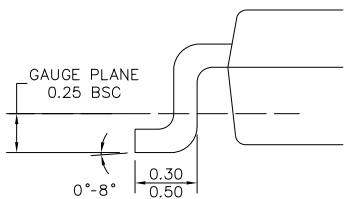

DETAIL "A"

NOTE:

- 1) ALL DIMENSIONS ARE IN MILLIMETERS.
- 2) PACKAGE LENGTH DOES NOT INCLUDE MOLD FLASH, PROTRUSION OR GATE BURR.
- 3) PACKAGE WIDTH DOES NOT INCLUDE INTERLEAD FLASH OR PROTRUSION.
- 4) LEAD COPLANARITY (BOTTOM OF LEADS AFTER FORMING) SHALL BE 0.10 MILLIMETERS MAX.
- 5) DRAWING CONFORMS TO JEDEC MO-193, VARIATION AB.
- 6) DRAWING IS NOT TO SCALE.
- 7) PIN 1 IS LOWER LEFT PIN WHEN READING TOP MARK FROM LEFT TO RIGHT (SEE EXAMPLE TOP MARK).

PACKAGE INFORMATION (continued)

TSOT23-8

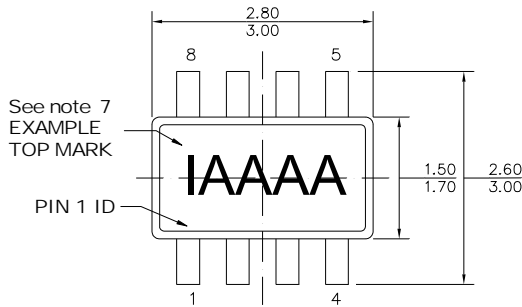

TOP VIEW

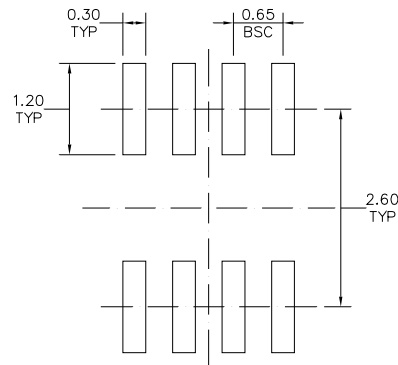

RECOMMENDED LAND PATTERN

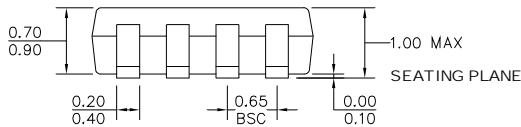

FRONT VIEW

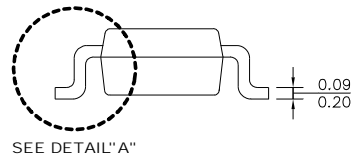

SIDE VIEW

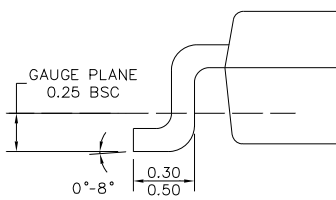

DETAIL "A"

NOTE:

- 1) ALL DIMENSIONS ARE IN MILLIMETERS
- 2) PACKAGE LENGTH DOES NOT INCLUDE MOLD FLASH PROTRUSION OR GATE BURR
- 3) PACKAGE WIDTH DOES NOT INCLUDE INTERLEAD FLASH OR PROTRUSION
- 4) LEAD COPLANARITY(BOTTOM OF LEADS AFTER FORMING) SHALL BE 0.10 MILLIMETERS MAX
- 5) JEDEC REFERENCE IS MO193, VARIATION BA
- 6) DRAWING IS NOT TO SCALE
- 7) PIN 1 IS LOWER LEFT PIN WHEN READING TOP MARK FROM LEFT TO RIGHT, (SEE EXAMPLE TOP MARK)

NOTICE: The information in this document is subject to change without notice. Please contact MPS for current specifications. Users should warrant and guarantee that third party Intellectual Property rights are not infringed upon when integrating MPS products into any application. MPS will not assume any legal responsibility for any said applications.

X-ON Electronics

Largest Supplier of Electrical and Electronic Components

Click to view similar products for [LED Lighting Drivers](#) category:

Click to view products by [Monolithic Power Systems](#) manufacturer:

Other Similar products are found below :

[LV5235V-MPB-H](#) [MB39C602PNF-G-JNEFE1](#) [MIC2871YMK-T5](#) [AL1676-10BS7-13](#) [AL1676-20AS7-13](#) [AP5726WUG-7](#) [ICL8201](#)
[IS31BL3228B-UTLS2-TR](#) [IS31BL3506B-TTLS2-TR](#) [AL3157F-7](#) [AP5725FDCG-7](#) [AP5726FDCG-7](#) [LV52204MTTBG](#) [AP5725WUG-7](#)
[STP4CMPQTR](#) [NCL30086BDR2G](#) [CAT4004BHU2-GT3](#) [LV52207AXA-VH](#) [AP1694AS-13](#) [TLE4242EJ](#) [AS3688](#) [IS31LT3172-GRLS4-TR](#)
[TLD2311EL](#) [KTD2694EDQ-TR](#) [KTZ8864EJAA-TR](#) [IS32LT3174-GRLA3-TR](#) [MP2488DN-LF-Z](#) [NLM0010XTSA1](#) [AL1676-20BS7-13](#)
[ZXLD1370QESTTC](#) [MPQ7220GF-AEC1-P](#) [MPQ7220GR-AEC1-P](#) [MPQ4425BGJ-AEC1-P](#) [MPQ7220GF-AEC1-Z](#) [MPQ7220GR-AEC1-Z](#)
[MPQ4425BGJ-AEC1-Z](#) [NCL30486A2DR2G](#) [IS31FL3737B-QFLS4-TR](#) [IS31FL3239-QFLS4-TR](#) [KTD2058EUAC-TR](#) [KTD2037EWE-TR](#)
[DIO5662ST6](#) [IS31BL3508A-TTLS2-TR](#) [KTD2026BEWE-TR](#) [MAX20052CATC/V+](#) [MAX25606AUP/V+](#) [BD6586MUV-E2](#) [BD9206EFV-](#)
[E2](#) [BD9416FS-E2](#) [LYT4227E](#)