



The Future of Analog IC Technology®

MP2603

Single-Cell 150mA Linear Li-Ion Battery Charger

DESCRIPTION

The MP2603 is a low cost single cell Li-ion battery charger IC suitable for low charge current applications. It features constant current (CC) and constant voltage (CV) charging modes with programmable charge current (50mA–150mA), trickle charge and charge status indication.

The MP2603 is enabled with an input supply voltage greater than 3.5V. The charger IC is disabled when unplugged from the AC adaptor. To minimize the charger’s total solution cost, the MP2603 does not need an external reverse blocking diode, a precision current-sense resistor or a compensation capacitor at the output. MP2603 is available in a 5-pin TSOT23 package.

EVALUATION BOARD REFERENCE

| Board Number | Dimensions |
|--------------|-----------------------|
| EV2603EJ-00B | 1.4”X x 1.1”Y x 0.5”Z |

FEATURES

- V_{IN} Surge Up to 25V
- 0.75% V_{BATT} Accuracy
- Low Battery Reverse Current, ($< 1\mu A$)
- Programmable Charge Current
- Over Temperature Protection
- Over Current Protection
- Charge Status Indication
- Over Charge Protection
- No External Sense Resistor Required
- No External Reverse Blocking Diode Required
- No Output Capacitor Required for Stability

APPLICATIONS

- Bluetooth Headset
- MP3 Players
- Mini PDAs
- Cell Phones
- Digital Cameras

All MPS parts are lead-free and adhere to the RoHS directive. For MPS green status, please visit MPS website under Products, Quality Assurance page. "MPS" and "The Future of Analog IC Technology" are registered trademarks of Monolithic Power Systems, Inc.

TYPICAL APPLICATION

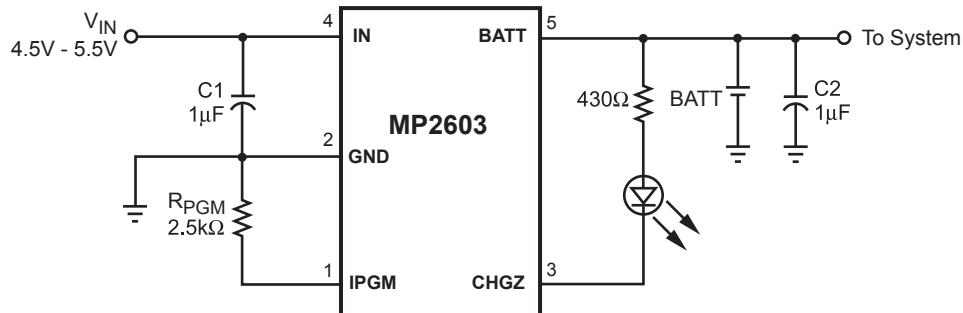

ORDERING INFORMATION

| Part Number* | Package | Top Marking |
|--------------|---------|-------------|
| MP2603EJ | TSOT23 | M3 |

* For Tape & Reel, add suffix -Z (e.g. MP2603EJ-Z).
 For RoHS compliant packaging, add suffix -LF (e.g. MP2603EJ-LF-Z)

PACKAGE REFERENCE

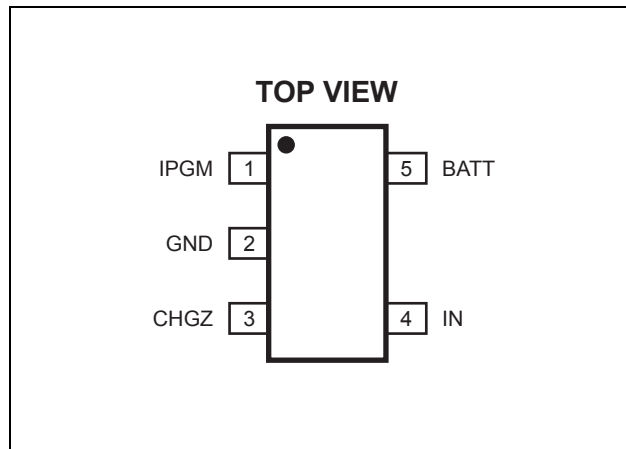

ABSOLUTE MAXIMUM RATINGS ⁽¹⁾

IN to GND-0.3V to +25V
 All Other Pins-0.3V to +6.5 V
 Continuous Power Dissipation ($T_A = +25^\circ\text{C}$) ⁽²⁾
 0.57W
 Junction Temperature 140°C
 Lead Temperature 260°C
 Storage Temperature..... -65°C to +150°C

Recommended Operating Conditions ⁽³⁾

Supply Voltage V_{IN} 4.75V to 5.25V
 Operating Temperature..... -20°C to +85°C

Thermal Resistance ⁽⁴⁾ θ_{JA} θ_{JC}
 TSOT23 220 110 .. °C/W

Notes:

- 1) Exceeding these ratings may damage the device.
- 2) The maximum allowable power dissipation is a function of the maximum junction temperature T_J (MAX), the junction-to-ambient thermal resistance θ_{JA} , and the ambient temperature T_A . The maximum allowable continuous power dissipation at any ambient temperature is calculated by P_D (MAX) = $(T_J$ (MAX) - T_A) / θ_{JA} . Exceeding the maximum allowable power dissipation will cause excessive die temperature, and the regulator will go into thermal shutdown. Internal thermal shutdown circuitry protects the device from permanent damage.
- 3) The device is not guaranteed to function outside of its operating conditions.
- 4) Measured on JESD51-7, 4-layer PCB.

ELECTRICAL CHARACTERISTICS

$V_{IN} = 5V$, $T_A = +25^{\circ}C$, unless otherwise noted.

| Parameter | Symbol | Condition | Min | Typ | Max | Units |
|--|--------------|---|------|------|------|-------------|
| Supply Current from V_{IN} | I_{SUPPLY} | $I_{CHG} = 0A$ | | 0.5 | | mA |
| Input Under Voltage Lockout | | Input Falling | 1.8 | 2.3 | 2.8 | V |
| Battery Reverse Current to BATT Pin | | $V_{BATT} = 4V$, Input = GND or Float | | | 2 | μA |
| Battery Voltage Regulation | V_{BATT} | $I_{CHG} = 5mA$, $0^{\circ}C < T_A < +50^{\circ}C$ | 4.16 | 4.20 | 4.24 | V |
| Constant Current Regulation ⁽⁵⁾ | I_{CHG} | $V_{IN} = 5V$, $V_{BATT} = 3.8V$, $R_{PGM} = 2.5k\Omega$ | 135 | 150 | 165 | mA |
| | | $V_{IN} = 5V$, $V_{BATT} = 3.8V$, $R_{PGM} = 1.5k\Omega - 7.2k\Omega$, $-20^{\circ}C < T_A < +85^{\circ}C$ | 90 | 100 | 110 | % I_{CHG} |
| | | $V_{IN} = 5V$, $V_{BATT} = 3.8V$, $7.2k\Omega < R_{PGM} \leq 12.4k\Omega$, $-20^{\circ}C < T_A < +85^{\circ}C$ | 70 | | 130 | % I_{CHG} |
| Trickle Charge Current | | $V_{IN} = 5V$, $V_{BATT} = 2.3V$ | 5 | 10 | 15 | % I_{CHG} |
| Trickle Threshold Voltage | | | 2.45 | 2.60 | 2.75 | V |
| Trickle Voltage Hysteresis | | | | 190 | | mV |
| CHGZ Low-to-High Threshold | | | 3 | 10 | 17 | % I_{CHG} |
| CHGZ Sink Current | | Pin Voltage = 0.2V | 5 | | | mA |
| Dropout Voltage | | $I_{CHG} = 150mA$, $V_{BATT} = 3.8V$ | | 640 | | mV |
| Thermal Limit ⁽⁶⁾ | | | | 130 | | $^{\circ}C$ |
| Overcharge Protection | | $V_{BATT} = 4.25V$ | | | 0 | μA |

Notes:

- 5) I_{CHG} is the target preprogrammed charge current (Die temperature below 110 $^{\circ}C$).
 6) Guaranteed by design.

PIN FUNCTIONS

| Pin # | Name | Description |
|-------|------|---|
| 1 | IPGM | Charge Current Program Pin. Connect to a resistor to program the charge current. Do not connect a capacitor to this pin. |
| 2 | GND | Chip Ground Return. Connect to the system ground. |
| 3 | CHGZ | Open-Drain Charge Status Indication Pin. It can be connected through an LED and a 430Ω resistor to BATT for visual indication or through a 1kΩ resistor to BATT for use with a microcontroller. |
| 4 | IN | Input Supply Pin. Connect to a 5V (±5%) power supply. The maximum surge voltage must be less than 25V. Decouple this pin with a minimum of 0.1μF ceramic capacitor. |
| 5 | BATT | Charger Output. Connect to the battery. Placing a capacitor to GND on this pin is optional. |

BLOCK DIAGRAM

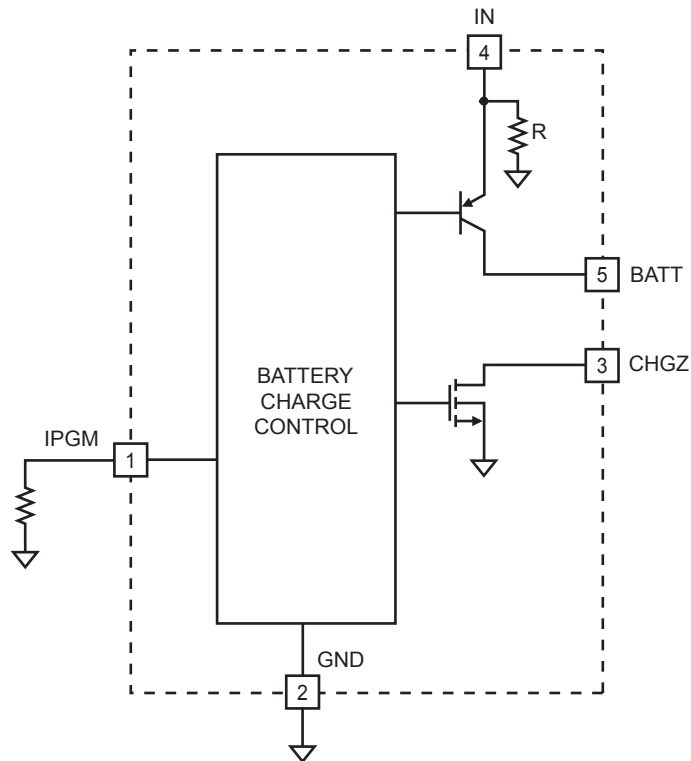
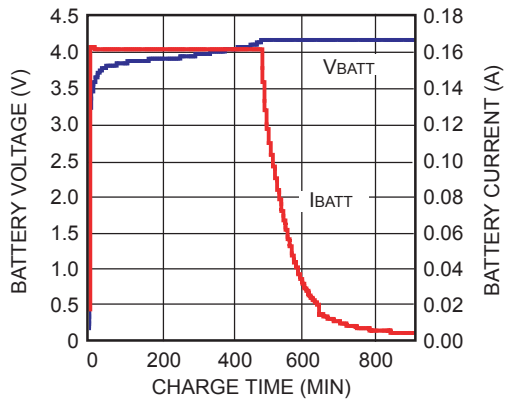

Figure 1—Functional Block Diagram

TYPICAL PERFORMANCE CHARACTERISTICS

$V_{IN} = 5V$, $C1 = 1\mu F$, $C2 = 1\mu F$, $T_A = +25^\circ C$, unless otherwise noted.

Battery Charge Curve



Charge Current vs Battery Voltage

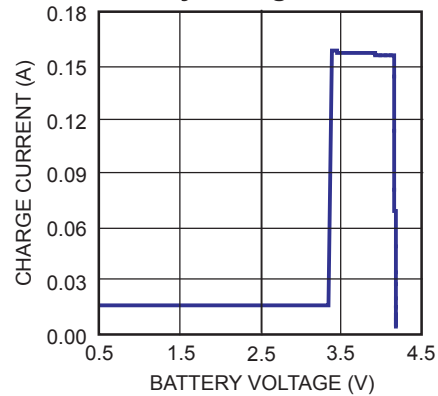

Battery Voltage vs Input Voltage

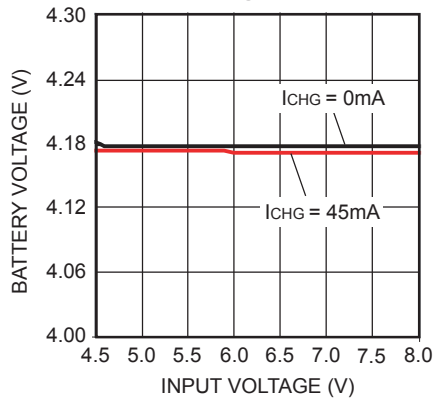

Charge Current vs Battery Voltage

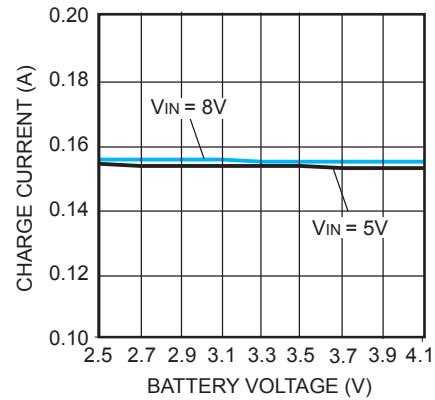

Charge Current vs Input Voltage

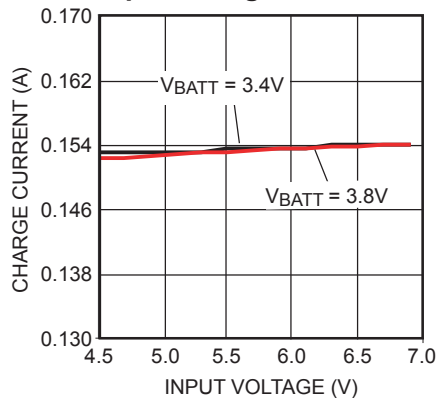

Charge Current vs R_{PGM} Resistance

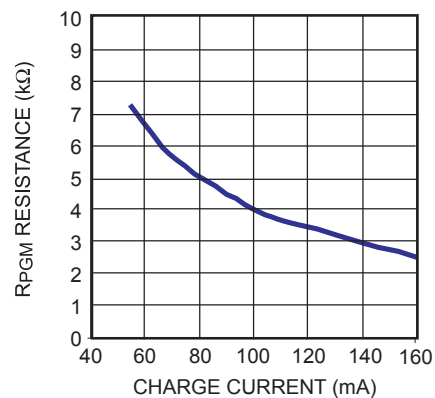

TYPICAL PERFORMANCE CHARACTERISTICS (continued)

$V_{IN} = 5V$, $C1 = 1\mu F$, $C2 = 1\mu F$, $T_A = +25^\circ C$, unless otherwise noted.

Forward Leakage Current

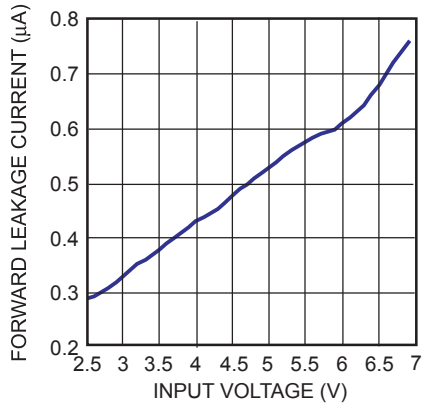

Reverse Current vs Battery Voltage

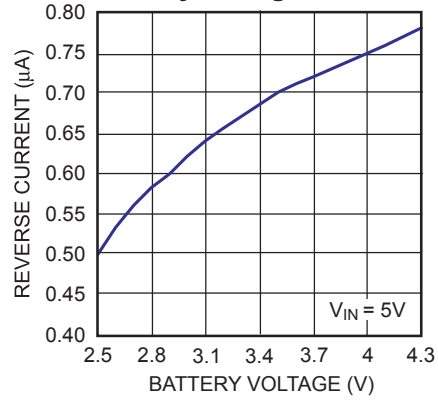

Charge Current vs Temperature

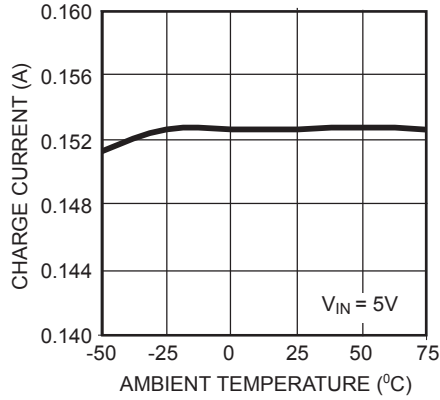

Battery Voltage vs Temperature

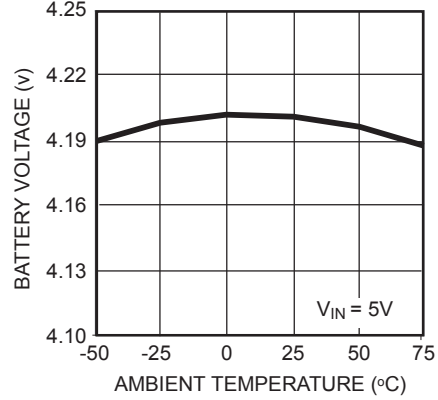

Power-On

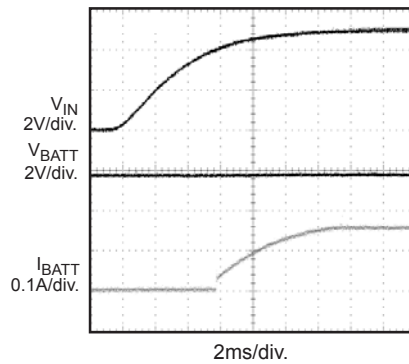

Power-Off

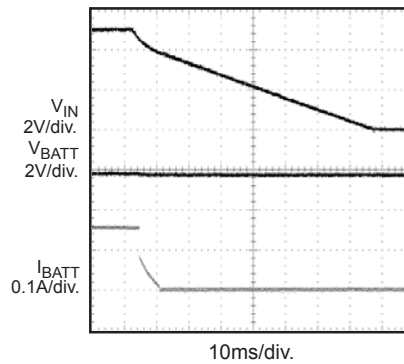

OPERATION

The MP2603 is enabled with a minimum input supply voltage of 3.5V. This power supply must also be higher than both the UVLO threshold and the battery voltage. There is an internal 500kΩ pull-down resistor connecting the IN and GND pins. The MP2603 provides CC/CV charge algorithms to automatically change modes depending on the battery status. Figure 2 shows the typical charging procedure for the MP2603.

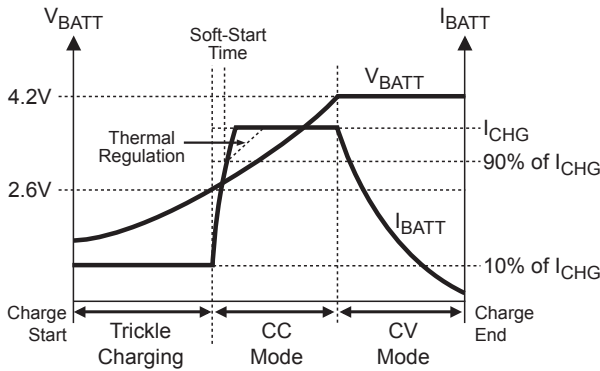

Figure 2—MP2603 Typical Charging Procedure

The charge current, I_{CHG} , is programmed by connecting a resistor (R_{PGM}) from the I_{PGM} pin to ground. The relationship of the charge current and the programming resistance is established by the following equation and graph. The Table1 lists the typical application setting of I_{chg} .

$$I_{CHG} = 150mA \times \frac{2.53k\Omega}{R_{PGM}} \quad (1)$$

Table 1— R_{PGM} and I_{CHG} Relationship

| R_{PGM} (kΩ) | I_{CHG} (mA) |
|----------------|----------------|
| 12.4 | 30 |
| 7.2 | 52 |
| 4.99 | 76 |
| 3.74 | 101 |
| 2.5 | 151 |

Charge Current vs 1/ R_{PGM} Resistance

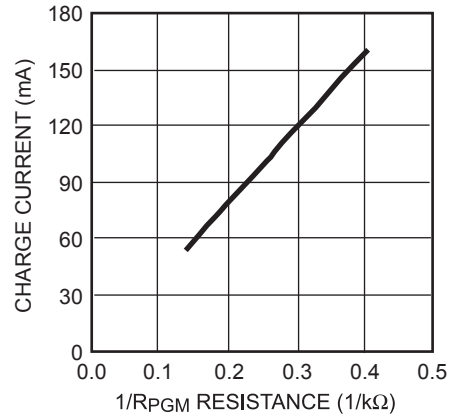

Figure 3— Charge Current vs 1/ R_{PGM} Resistance

When battery voltage falls below the trickle threshold (2.6V), charge current is limited to 10% of the programmed value to trickle charge the fully depleted battery. After the battery voltage reaches 2.6V, the charger begins to charge at the constant current of the programmed value (I_{CHG}). This is referred to as Constant Current (CC) mode. Once the battery voltage reaches 4.2V, the charger will operate in the Constant Voltage (CV) mode until the battery is fully charged.

Charge Status (CHGZ)

The open-drain CHGZ pin monitors charge status by connecting to V_{BATT} through an LED and/or a resistor. The end-of-charge, or battery full, is indicated by the CHGZ pin changing from LOW to HIGH (i.e. LED turns off) when I_{CHG} decreases to 10% of the programmed value.

Thermal Protection

To prevent overheating, the MP2603 automatically limits the die temperature to 130°C by reducing the internal current-setting reference voltage. In the thermal protection mode, the charge current reduces automatically, but remains continuous.

APPLICATION

Flow Chart of Operation

Power-On Reset (POR) feature can be applied to the MP2603 to ensure that the device starts operating in a known state when power is applied. The flow chart in Figure 4 describes

the conditions and operation modes of the MP2603. CVC and CCC stand for “constant voltage charge” and “constant current charge”, respectively.

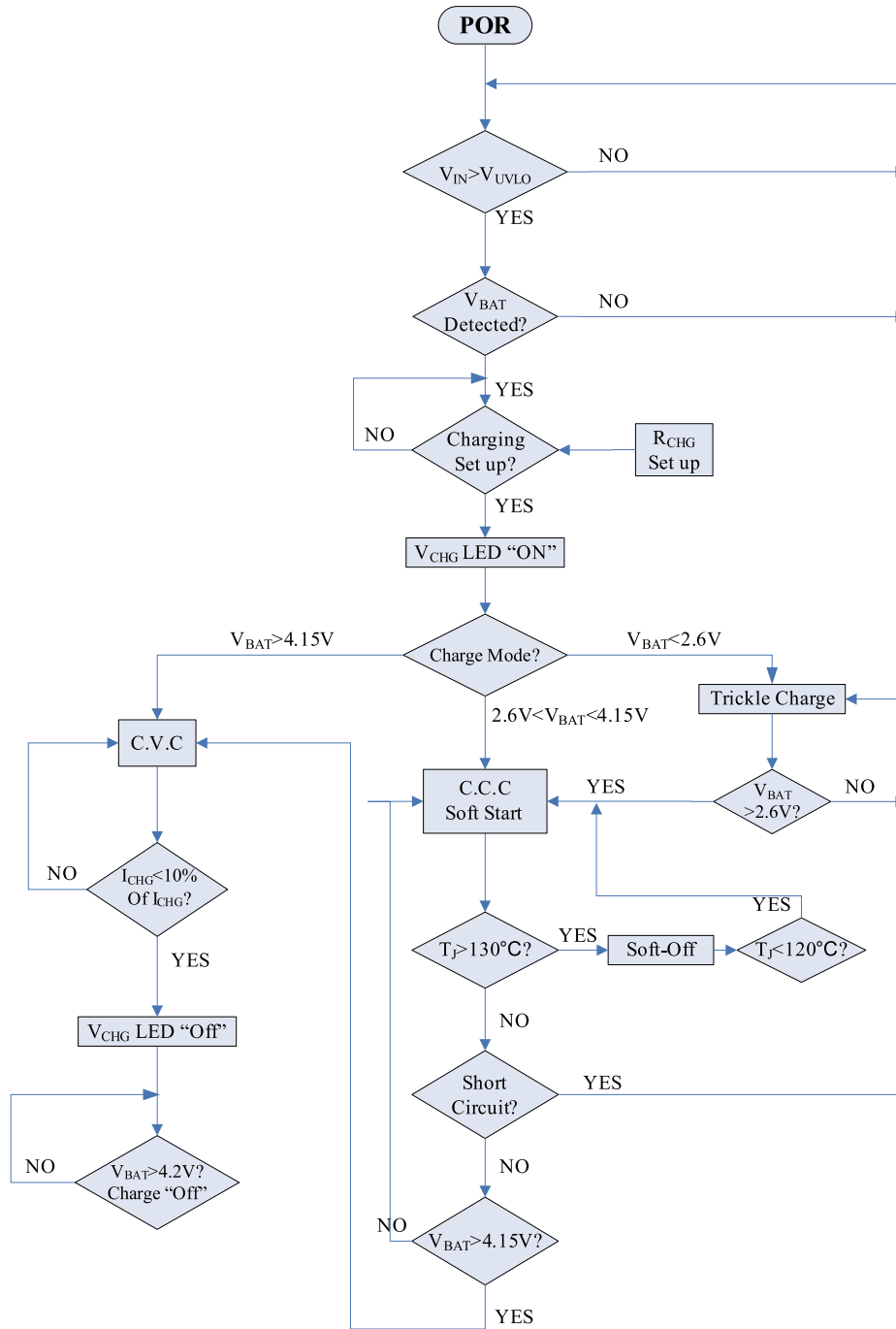
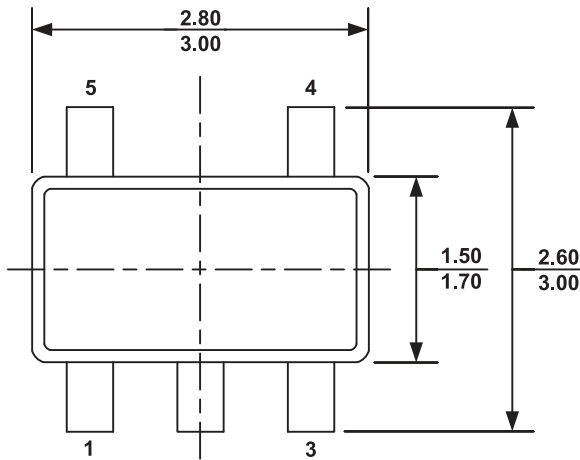
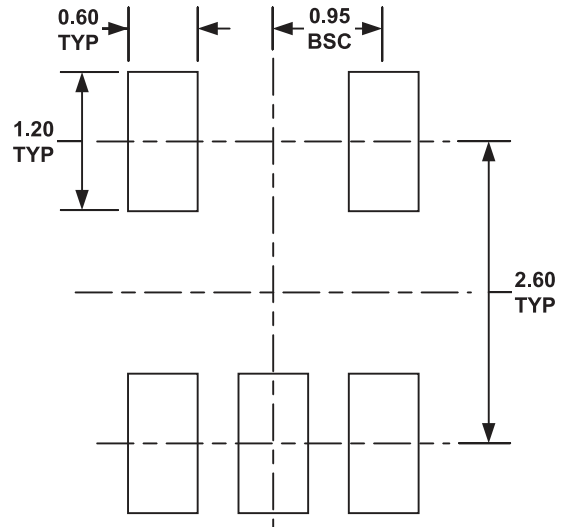
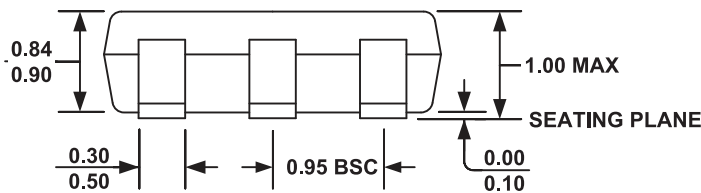
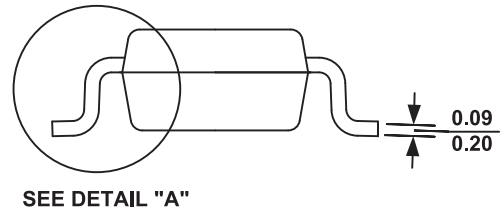
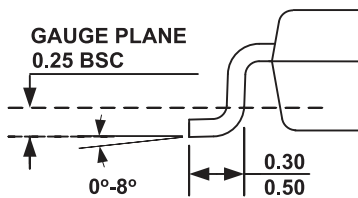

Figure 4—Flow Chart of Operation

PACKAGE INFORMATION
TSOT23-5

TOP VIEW

RECOMMENDED LAND PATTERN

FRONT VIEW

SIDE VIEW

DETAIL "A"
NOTE:

- 1) ALL DIMENSIONS ARE IN MILLIMETERS.
- 2) PACKAGE LENGTH DOES NOT INCLUDE MOLD FLASH, PROTRUSION OR GATE BURR.
- 3) PACKAGE WIDTH DOES NOT INCLUDE INTERLEAD FLASH OR PROTRUSION.
- 4) LEAD COPLANARITY (BOTTOM OF LEADS AFTER FORMING) SHALL BE 0.10 MILLIMETERS MAX.
- 5) DRAWING CONFORMS TO JEDEC MO-193, VARIATION AA.
- 6) DRAWING IS NOT TO SCALE.

NOTICE: The information in this document is subject to change without notice. Users should warrant and guarantee that third party Intellectual Property rights are not infringed upon when integrating MPS products into any application. MPS will not assume any legal responsibility for any said applications.

X-ON Electronics

Largest Supplier of Electrical and Electronic Components

Click to view similar products for [Battery Management](#) category:

Click to view products by [Monolithic Power Systems](#) manufacturer:

Other Similar products are found below :

[MP26121DQ-LF-P](#) [NCP1855FCCT1G](#) [FAN54063UCX](#) [LC05132C01NMTTTG](#) [SN2040DSQR](#) [ME4075AM5G](#) [AP5054HTCER](#) [XPD977B](#)
[XPD977B18](#) [4056H](#) [DW01](#) [DW06](#) [CM1002-UD](#) [CM1002-W](#) [CM1002-X](#) [CM1002-Y](#) [CM1006-B](#) [CM1006-Q](#) [CM1006-WB](#) [CM1006-LCD](#)
[CM1006-LBD](#) [CM1006-WF](#) [CM1006-LF](#) [CM1006-WG](#) [CM1006-WH](#) [CM1006-LG](#) [CM1003-S02BD](#) [CM1003-S09EA](#) [CM1003-S10ED](#)
[CM1003-S11ED](#) [CM1003-S12BC](#) [CM1003-S13CC](#) [CM1003-S24BC](#) [CM1003-S26BC](#) [CM1003-WAD](#) [CM1003-BBD](#) [CM1003-BFD](#)
[CM1003-BND](#) [CM1003-BLD](#) [CM1003-DAD](#) [CM1003-BMD](#) [CM1003-BPD](#) [CM1003-BKD](#) [CM1003-BAE](#) [CM1003-BHE](#) [CM1102B-FF](#)
[CM1102B-FD](#) [CM1102B-GD](#) [CM1112-DAE](#) [CM1112-DBE](#)