



MP2696A

I²C-Controlled, Single-Cell Switching Charger with Power-Path Management and 3.6A Boost Output

DESCRIPTION

The MP2696A is a highly integrated, flexible, switch-mode battery-charging, power-path management device designed for a single-cell Li-ion and Li-polymer battery to be used in a wide range of portable applications.

The MP2696A integrates three battery-charging phases: pre-charge, constant-current, and constant-voltage charge. This device also manages the input power source through input current limit regulation and minimum input voltage regulation.

The MP2696A can switch to boost mode to generate the system power output from the battery.

The MP2696A has an integrated IN to SYS pass-through path to pass the input voltage to the system.

Using an I²C interface, the host can flexibly program the charge and boost parameters. The device operating status can also be read in the registers.

Safety features include SYS short-circuit protection, input over-voltage protection, battery under-voltage protection, thermal shutdown, and JEITA battery temperature monitoring.

The MP2696A is available in a QFN-21 (3mmx3mm) package.

FEATURES

- 4.0V to 11V Operation Voltage Range
- Up to 16V Sustainable Input Voltage
- 500mA to 3.6A Programmable Charge Current
- 3.6V to 4.45V Programmable Charge Regulation Voltage with $\pm 0.5\%$ Accuracy
- 100mA to 3A Programmable Input Current Limit with $\pm 10\%$ Accuracy
- Minimum Input Voltage Loop for Maximum Adapter Power Tracking
- Ultra-Low 25 μ A Battery Discharge Current in Idle Mode
- Boost Converter w/ Up to 3.6A Output Current:
 - Programmable Output Current Limit Loop
 - Programmable Boost Output Voltage
 - USB Output Cable Compensation
 - Programmable Inductor Peak Current Limiting
- Comprehensive Safety Features
 - Fully-Customizable JEITA Profile with Programmable Temperature Threshold
 - Charge Safety Timer
 - Input Over-Voltage Protection
 - Thermal Shutdown
 - SYS Over-Current and Short Protection
- Analog Voltage Output IB Pin for Battery Current Monitoring
- SYS Plug-In Detection
- SYS No Load Detection
- SYS DP/DM Interface for BC1.2 and Non-Standard Adapters
- Status and Fault Monitoring
- Available in a QFN-21 (3mmx3mm) Package

APPLICATIONS

- Sub-Battery Applications
- Power Bank Applications for Smartphone, Tablet, and Other Portable Devices

All MPS parts are lead-free, halogen-free, and adhere to the RoHS directive. For MPS green status, please visit the MPS website under Quality Assurance. "MPS", the MPS logo, and "Simple, Easy Solutions" are registered trademarks of Monolithic Power Systems, Inc. or its subsidiaries.

TYPICAL APPLICATION

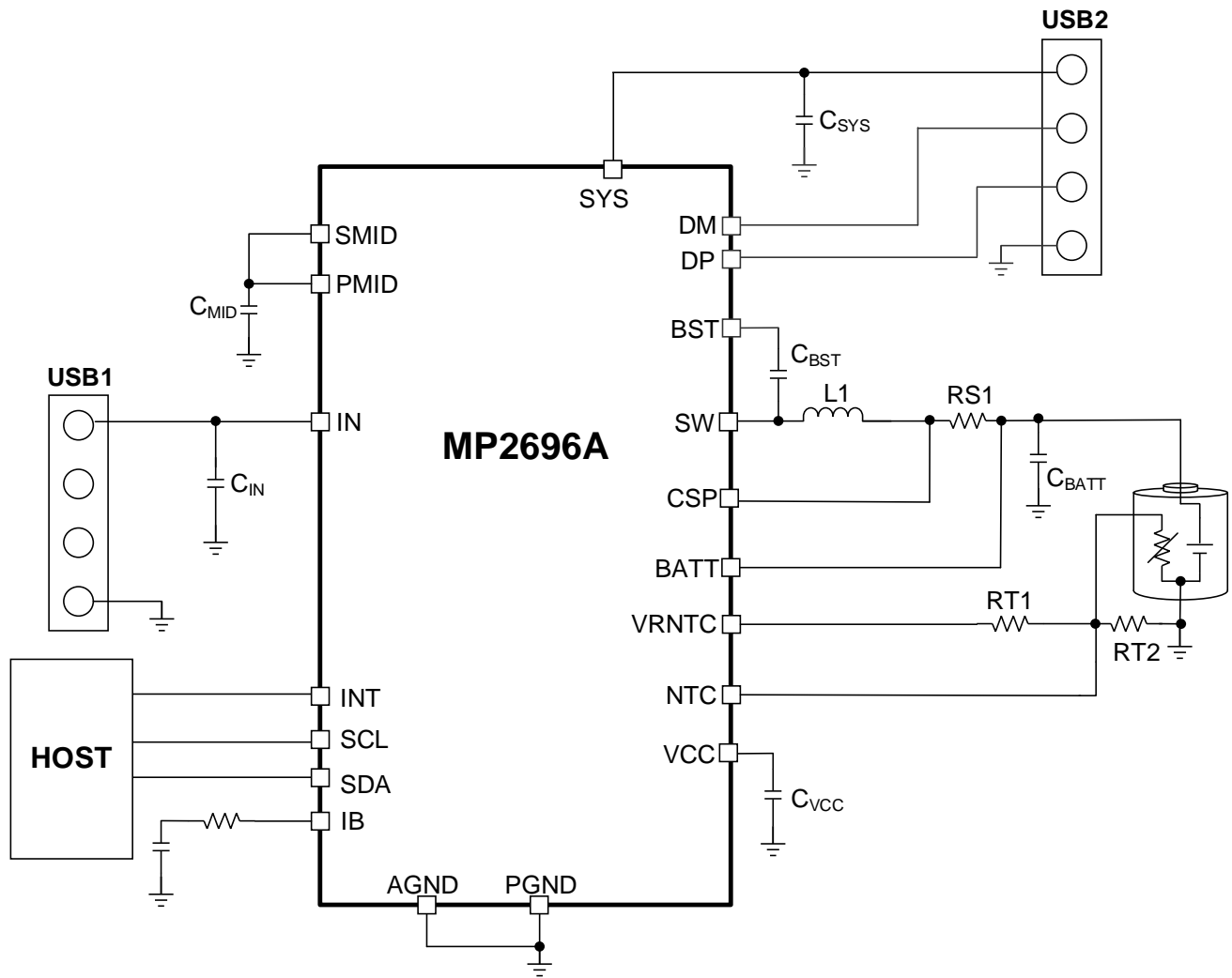

ORDERING INFORMATION

Part Number*	Package	Top Marking
MP2696AGQ-0000**	QFN-21 (3mmx3mm)	See Below
EVKT-MP2696A	Evaluation kit	

* For Tape & Reel, add suffix -Z (e.g. MP2696AGQ-xxxx-Z).

**“xxxx” is the register setting option. The factory default is “0000.” This content can be viewed in the I²C register map. Contact an MPS FAE to obtain an “xxxx” value.

TOP MARKING

BKZY
LLL

BKZ: Product code of MP2696AGQ
 Y: Year code
 LLL: Lot number

EVALUATION KIT EVKT-MP2696A

EVKT-MP2696A kit contents (items below can be ordered separately):

#	Part Number	Item	Quantity
1	EV2696A-Q-00B	MP2696A evaluation board	1
2	EVKT-USBI2C-02 bag	Includes one USB to I ² C communication interface, one USB cable, and one ribbon cable	1
3	Online resources	Include datasheet, user guide, product brief, and GUI	1

Order directly from MonolithicPower.com or our distributors.

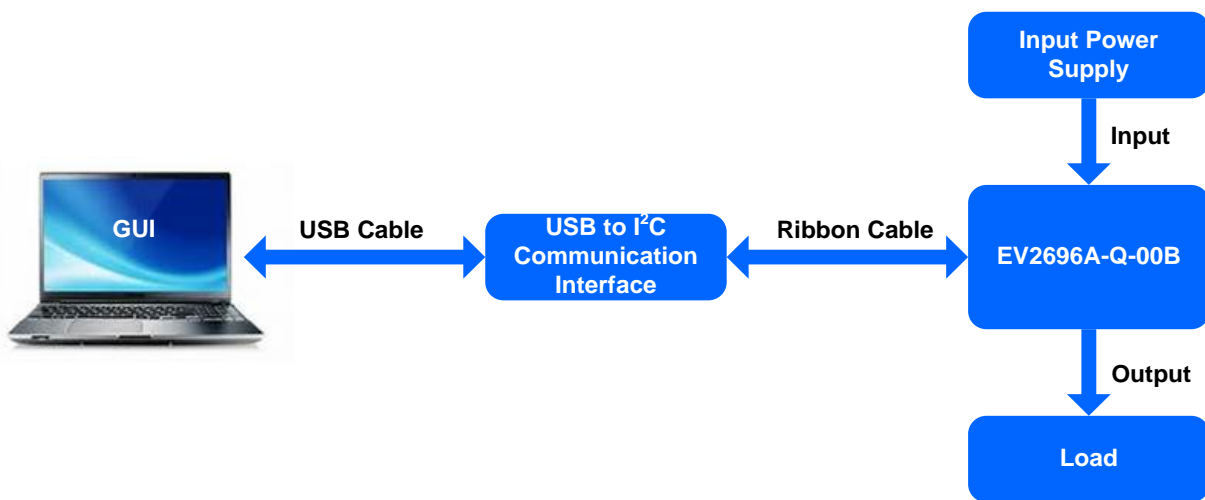
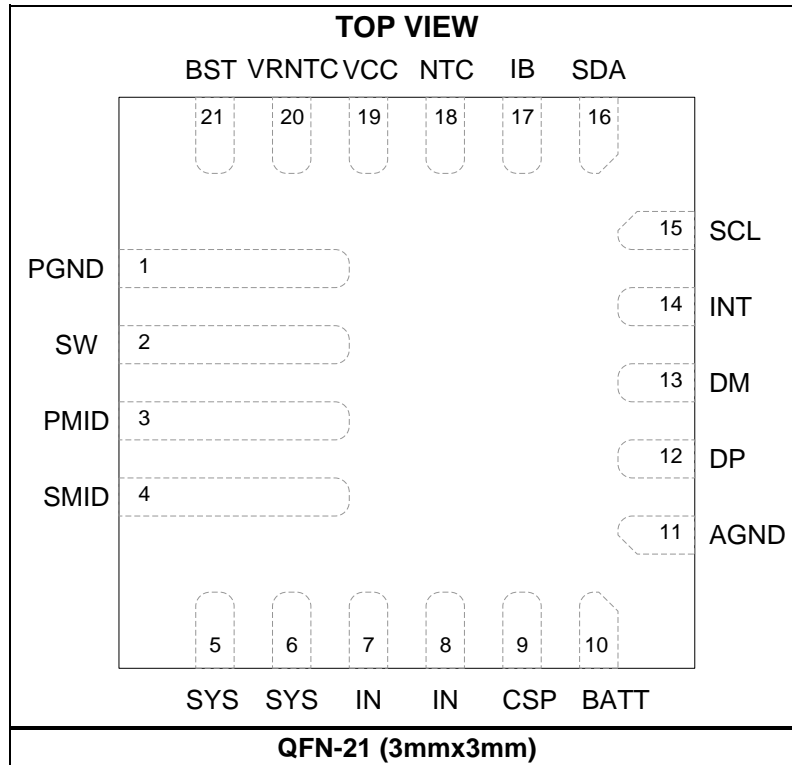

Figure 1: EVKT-MP2696A Evaluation Kit Set-Up

PACKAGE REFERENCE



PIN FUNCTIONS

Pin #	Name	I/O	Description
1	PGND	Power	Power ground.
2	SW	Power	Switching output node. Connect SW to the inductor.
3	PMID	Power	Drain of the high-side switching MOSFET. Bypass PMID with ceramic capacitors from PMID to PGND, placed as close to the IC as possible. This pin cannot carry an external load.
4	SMID	Power	Connected to the drain of Q1 and Q2. Short SMID to PMID on the PCB.
5,6	SYS	Power	System power output. Place ceramic capacitors from SYS to PGND.
7,8	IN	Power	Power input of the IC. Place ceramic capacitors from IN to PGND.
9	CSP	I	Battery current sense positive input.
10	BATT	I	Battery positive terminal.
11	AGND	Power	Analog ground. Short to PGND on the PCB.
12	DP	I/O	Positive port of the USB data for the output. High ESD rating.
13	DM	I/O	Negative port of the USB data for the output. High ESD rating.
14	INT	O	Open-drain interrupt output. Connect INT to the logic rail through a 10kΩ resistor.
15	SCL	I	I²C interface clock. Connect SCL to the logic rail through a 10kΩ resistor.
16	SDA	I/O	I²C interface data. Connect SDA to the logic rail through a 10kΩ resistor.
17	IB	O	Battery current indicator. The voltage at IB indicates the charge current to the battery in charge mode, and the discharge current of the battery in boost mode.
18	NTC	I	Temperature sense input. Connect NTC to a negative temperature coefficient thermistor. Program the temperature window with a resistor divider from VRNTC to NTC to GND. Programmable JEITA thresholds are supported.
19	VCC	Power	Internal circuit and switch driver power supply. Bypass to AGND with a ceramic capacitor as close to the IC as possible. For the external load capacity, see the VCC Power Supply section on page 16.
20	VRNTC	Power	Reference voltage output for powering up NTC.
21	BST	Power	Bootstrap. Connect a 470nF bootstrap capacitor between BST and SW to form a floating supply across the high-side power switch driver.

ABSOLUTE MAXIMUM RATINGS ⁽¹⁾

IN, PMID, SMID, SYS to PGND ...	-0.3V to +16V
SW to PGND	-0.3V (-2V for 20ns) to
.....	+14V (16V for 20ns)
BST to PGND.....	SW to SW + 5V
All other pins to AGND.....	-0.3V to +5V
Continuous power dissipation (T _A = 25°C) ⁽²⁾2.5W
Junction temperature	150°C
Lead temperature (solder)	260°C
Storage Temperature.....	-65°C to +150°C

Recommended Operating Conditions ⁽³⁾

Supply voltage (V _{IN})	4V to 11V
Input current (I _{IN})	Up to 3A
System current (I _{SYS}).....	Up to 3.6A
Charge current (I _{CC})	Up to 3.6A
Battery voltage (V _{BATT})	Up to 4.5V
Operating junction temp (T _J)	-40°C to +125°C

Thermal Resistance ⁽⁴⁾ **θ_{JA}** **θ_{JC}**

QFN-21 (3mmx3mm)	50.....	12... °C/W
------------------------	---------	------------

ESD Ratings

DP, DM pins:

Human body model (HBM) ⁽⁵⁾	8000V
---	-------

Charged device model (CDM) ⁽⁶⁾	800V
---	------

All other pins:

Human body model (HBM) ⁽⁵⁾	2000V
---	-------

Charged device model (CDM) ⁽⁶⁾	250V
---	------

Notes:

- 1) Exceeding these ratings may damage the device.
- 2) The maximum allowable power dissipation is a function of the maximum junction temperature T_J (MAX), the junction-to-ambient thermal resistance θ_{JA}, and the ambient temperature T_A. The maximum allowable continuous power dissipation at any ambient temperature is calculated by P_D (MAX) = (T_J (MAX) - T_A) / θ_{JA}. Exceeding the maximum allowable power dissipation will cause excessive die temperature, and the regulator will go into thermal shutdown. Internal thermal shutdown circuitry protects the device from permanent damage.
- 3) The device is not guaranteed to function outside of its operating conditions.
- 4) Measured on JESD51-7, 4-layer PCB.
- 5) Per ANSI/ESDA/JEDEC JS-001.
- 6) Per JESD22-C101.

ELECTRICAL CHARACTERISTICS

V_{IN} = 5V, V_{BATT} = 3.5V, R_{S1} = 10mΩ, T_A = 25°C, unless otherwise noted.

Parameters	Symbol	Condition	Min	Typ	Max	Units
Quiescent Current						
Battery discharge current in IDLE mode	I _{BATT_IDLE}	Idle mode		25	36	μA
Input quiescent current without switching	I _{IN_Q}	V _{IN} > V _{IN_UVLO} , V _{IN} > V _{BATT} + V _{HDRM} , charge disabled, float SYS		0.6	1	mA
Input quiescent current when switching	I _{IN_QSW}	V _{IN} > V _{IN_UVLO} , V _{IN} > V _{BATT} + V _{HDRM} , charge enabled, float BATT and SYS		1		mA
Battery discharge current in boost mode	I _{BOOST_Q}	I _{SYS} = 0, V _{BOOST} [2:0] = 5.15V, boost enabled, V _{BATT} = 4.2V		2		mA
Power On/Off						
IN operating range	V _{IN_OP}	Converter switching	4		11	V
Input under-voltage lockout	V _{IN_UV}	V _{IN} falling	2.95	3.10	3.25	V
Input under-voltage lockout hysteresis		V _{IN} rising		305		mV
Input vs. battery headroom	V _{HDRM}	V _{IN} rising		200	310	mV
		V _{IN} falling	10	80		mV
Battery under-voltage lockout	V _{BATT_UV}	During boost	2.4	2.5	2.6	V
		Before boost starts	2.8	2.9	3.0	V
VCC LDO output voltage	V _{VCC}	V _{IN} = 5V, I _{VCC} = 30mA	3.3	3.55	3.8	V
VCC under-voltage lockout	V _{CC_UV}	VCC rising	1.9	2.1	2.3	V
VCC under-voltage lockout hysteresis				80		mV
Power Path						
IN to PMID FET (Q1) on resistance	R _{ON_Q1}			25		mΩ
PMID to SYS FET (Q2) on resistance	R _{ON_Q2}			15		mΩ
High-side FET (Q3) on resistance	R _{ON_HS}			15		mΩ
Low-side FET (Q4) on resistance	R _{ON_LS}			14		mΩ
Peak current limit for high-side FET in buck mode	I _{HS_PK}	CC charge mode		6.5		A
		Pre-charge mode		1.3		A
Peak current limit for low-side FET in boost mode	I _{LS_PK}	BST_IPK[1:0] = 6.5A	5.9	6.6	7.3	A
		BST_IPK[1:0] = 5A	4.1	4.8	5.5	A
Switching frequency	f _{SW}	SW_FREQ = 700kHz		720		kHz
		SW_FREQ = 1200kHz		1200		kHz

ELECTRICAL CHARACTERISTICS (continued)
V_{IN} = 5V, V_{BATT} = 3.5V, R_{S1} = 10mΩ, T_A = 25°C, unless otherwise noted.

Parameters	Symbol	Condition	Min	Typ	Max	Units
Charge Mode						
Charge voltage regulation	V _{BATT_REG}	BATT_REG range ⁽⁷⁾	3.6		4.45	V
		BATT_REG[2:0] = 3.6V	3.582	3.6	3.618	V
		BATT_REG[2:0] = 4.1V	4.080	4.1	4.120	V
		BATT_REG[2:0] = 4.2V	4.179	4.2	4.221	V
		BATT_REG[2:0] = 4.3V	4.279	4.3	4.321	V
		BATT_REG[2:0] = 4.35V	4.328	4.35	4.372	V
		BATT_REG[2:0] = 4.4V	4.378	4.40	4.422	V
		BATT_REG[2:0] = 4.45V	4.428	4.45	4.472	V
Fast charge current	I _{CC}	ICC[4:0] = 3A	2.7	3	3.4	A
		ICC[4:0] = 1.5A	1.35	1.5	1.7	A
		ICC[4:0] = 0.5A	0.41	0.5	0.6	A
Charge termination current	I _{TERM}	ITERM[1:0] = 100mA	40	100	160	mA
		ITERM[1:0] = 200mA	100	200	300	mA
Recharge threshold below V _{BATT_REG}	V _{RECH}	V _{BATT} falling	100	200	320	mV
Pre-charge to fast charge threshold	V _{BATT_PRE}	V _{BATT} rising	2.9	3.0	3.1	V
Pre-charge to fast charge hysteresis		V _{BATT} falling		290		mV
Pre-charge current	I _{PRE}	IPRE[1:0] = 150mA, V _{BATT} = 1.8V		150		mA
		IPRE[1:0] = 350mA, V _{BATT} = 1.8V		350		mA
Safety timer for charging cycle				20		hours
Input Regulation						
Input minimum voltage regulation	V _{IN_MIN}	VINMIN[2:0] = 4.5V	4.41	4.51	4.61	V
		VINMIN[2:0] = 4.65V	4.56	4.66	4.76	V
Input current limit	I _{IN_LIM}	IINLIM[2:0] = 3A	2.7	2.85	3	A
		IINLIM[2:0] = 1.5A	1.3	1.4	1.5	A
		IINLIM[2:0] = 0.5A	0.4	0.45	0.5	A
Boost Mode						
Boost output voltage at PMID	V _{PMID_BST}	VBOOST[2:0] = 5.15V, I _{SYS} = 10mA	5.05	5.13	5.21	V
		VBOOST[2:0] = 5.225V, I _{SYS} = 10mA	5.13	5.21	5.29	V
Boost output current limit	I _{BST_LMT}	IOLIM[3:0] = 3.6A	3.55	3.7	3.85	A
		IOLIM[3:0] = 2.8A	2.7	2.8	2.9	A
		IOLIM[3:0] = 2.1A	1.9	2.05	2.15	A

ELECTRICAL CHARACTERISTICS (continued)
 $V_{IN} = 5V$, $V_{BATT} = 3.5V$, $R_{S1} = 10m\Omega$, $T_A = 25^\circ C$, unless otherwise noted.

Parameters	Symbol	Condition	Min	Typ	Max	Units
Analog Control						
SYS no load current threshold	I _{BST_OFF}	NOLOAD_THR[1:0] = 30mA		30		mA
		NOLOAD_THR[1:0] = 50mA		50		mA
		NOLOAD_THR[1:0] = 75mA		75		mA
		NOLOAD_THR[1:0] = 100mA		100		mA
SYS plug-in detection threshold	V _{PLUG_IN}	SYS falling, percentage of V _{BATT}	70	75	80	%
Discharge dummy load at IN	R _{IN_DUM}			250		Ω
Discharge dummy load at SYS	R _{SYS_DUM}			30		Ω
Protection						
Battery over-voltage threshold	V _{BATT_OVP}		102	104	106	%
BATT over-voltage hysteresis				1.5		%
IN over-voltage protection	V _{IN_OVP}	V _{IN} rising, V _{IN_OVP} = 6V	5.8	6	6.2	V
		V _{IN} rising, V _{IN_OVP} = 11V	10.6	11	11.4	V
IN over-voltage protection hysteresis		V _{IN} falling		300		mV
Thermal Shutdown and Temperature Control						
Thermal shutdown rising threshold ⁽⁷⁾	T _{J_SHDN}	T _J rising		150		°C
Thermal shutdown hysteresis ⁽⁷⁾				20		°C

ELECTRICAL CHARACTERISTICS (continued)
V_{IN} = 5V, V_{BATT} = 3.5V, R_{S1} = 10mΩ, T_A = 25°C, unless otherwise noted.

Parameters	Symbol	Condition	Min	Typ	Max	Units
VRNTC voltage	V _{VRNTC}	V _{IN} = 5V, I _{VRNTC} = 100μA		3.5		V
NTC low temp rising threshold	V _{COLD}	As percentage of V _{VRNTC} , V _{COLD} [1:0] = 72%	72	73.1	74.3	%
NTC low temp rising threshold hysteresis		As percentage of V _{VRNTC}		1.6		%
NTC cool temp rising threshold	V _{COOL}	As percentage of V _{VRNTC} , V _{COOL} [1:0] = 60%	59.7	61	62.2	%
NTC cool temp rising threshold hysteresis		As percentage of V _{VRNTC}		1.6		%
NTC warm temp falling threshold	V _{WARM}	As percentage of V _{VRNTC} , V _{WARM} [1:0] = 40%	39.4	40.6	42	%
NTC warm temp falling threshold hysteresis		As percentage of V _{VRNTC}		1.6		%
NTC hot temp falling threshold	V _{HOT}	As percentage of V _{VRNTC} , V _{HOT} [1:0] = 36%	35.3	36.6	37.9	%
NTC hot temp falling threshold hysteresis		As percentage of V _{VRNTC}		1.6		%
SYS DP/DM Signaling						
DP/DM source voltage 2V7	V _{SRC_2V7}		2.6	2.7	2.8	V
DP/DM source resistance	R _{SRC}		23	30	37	kΩ
DP/DM comparator threshold 2.9V	V _{TH_2V9}		2.75	2.9	3.1	V
DP/DM comparator threshold 2.1V	V _{TH_2V1}		1.95	2.1	2.25	V
Deglitch time for exiting non-standard adapter			8	10	12	ms
DP/DM short resistance	R _{SHORT}			100		Ω
Pull-down resistor on DP pin	R _{PULL_DWN}			300		kΩ
Timer for DCP to enter non-standard adapter				2		s
I²C Interface						
Input high threshold level		SDA and SCL	1.3			V
Input low threshold level		SDA and SCL			0.4	V
Output low threshold level		I _{SINK} = 5mA			0.3	V
I ² C clock frequency	f _{SCL}				400	kHz
Battery Current Indicator						
IB voltage output		I _{CC} = 1A in charge mode	0.33	0.35	0.37	V
		I _{DSCHG} = 1A in boost mode	0.15	0.16	0.17	V

Notes:

7) Guaranteed by design.

TYPICAL CHARACTERISTICS

I_{BATT_LKG} @ BATT = 5V vs. Junction Temperature

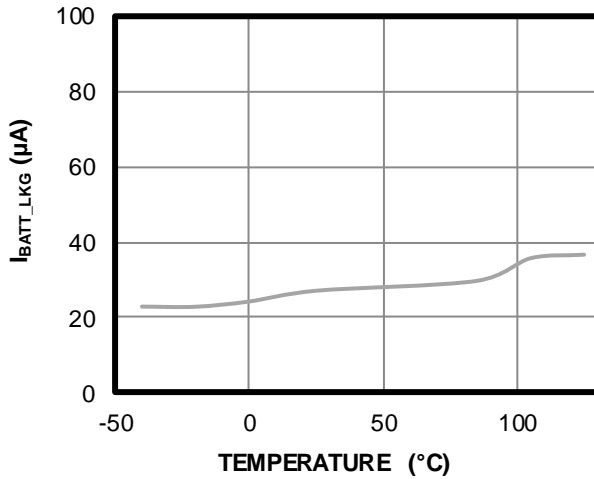

V_{BATT_REG} = 4.2V vs. Junction Temperature

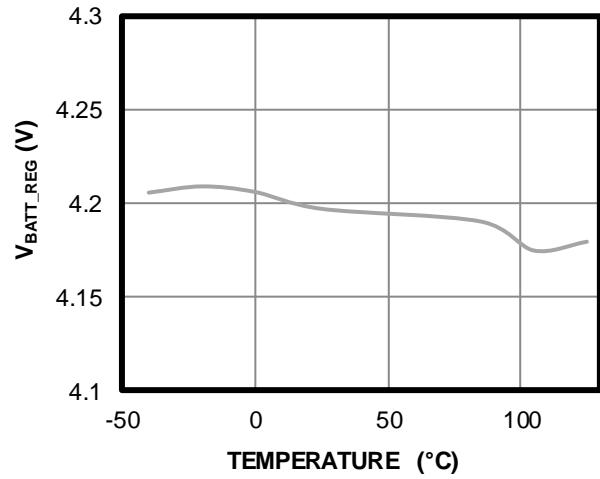

I_{CC} = 3A vs. Junction Temperature

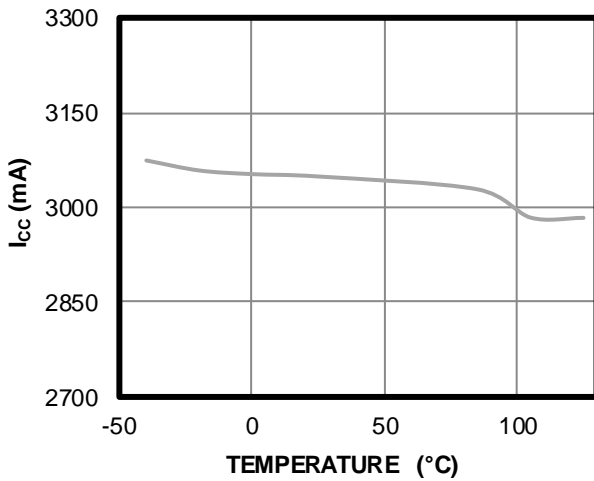

I_{TERM} = 100mA vs. Junction Temperature

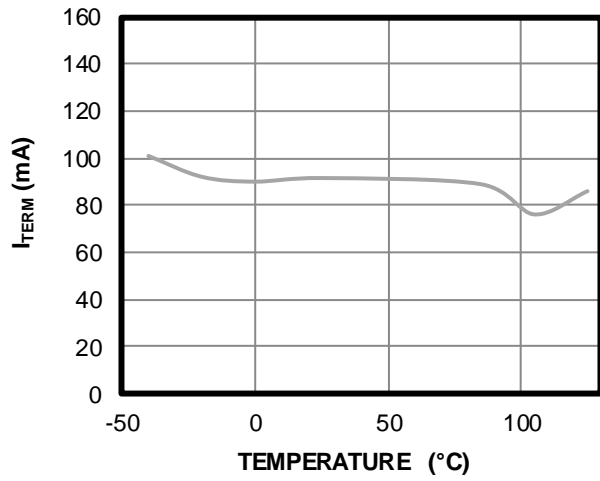

I_{IN_LIMIT} = 3A vs. Junction Temperature

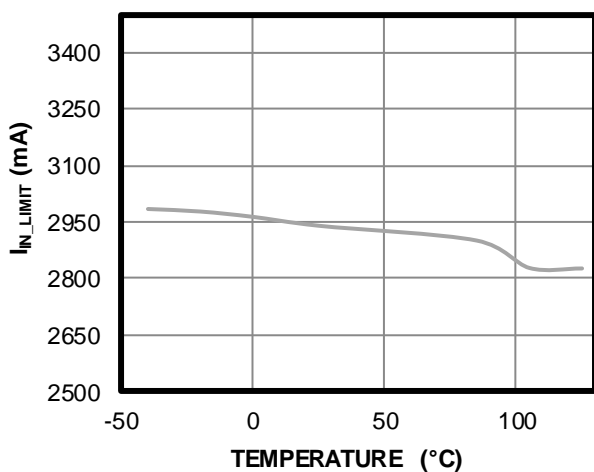

V_{IN_MIN} = 4.65V vs. Junction Temperature

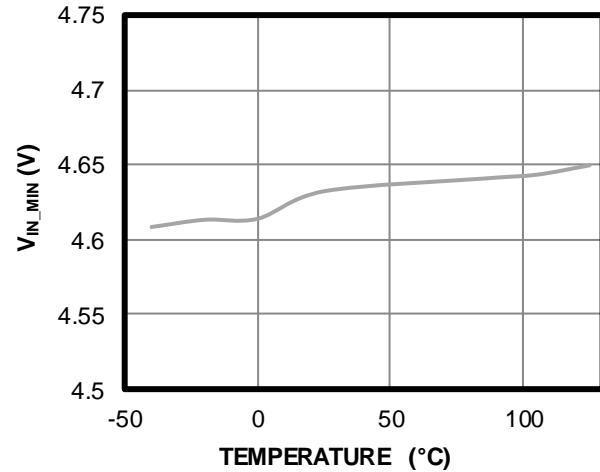

TYPICAL CHARACTERISTICS (continued)

V_{BATT_UVLO_FALLING} vs. Junction Temperature

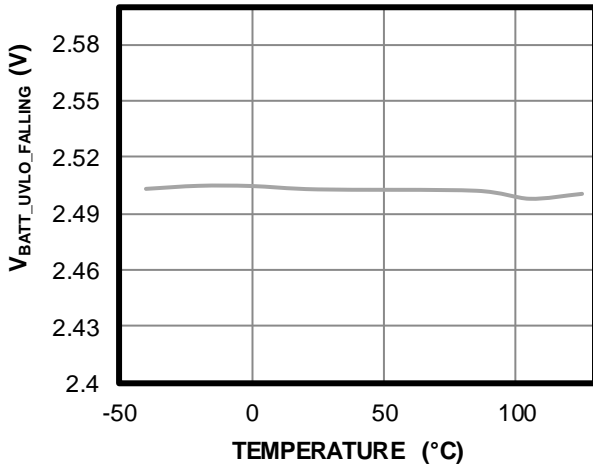

I_{NOLOAD_THRESHOLD} = 30mA vs. Junction Temperature

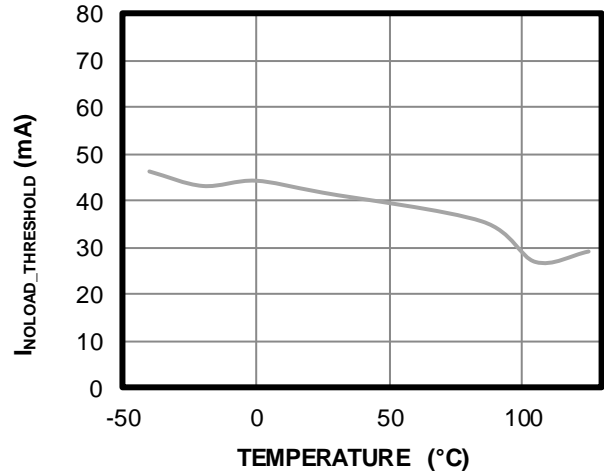

TYPICAL PERFORMANCE CHARACTERISTICS

T_A = 25°C, battery simulator load, unless otherwise noted.

Constant Current Charge Efficiency

V_{IN} = 5V, I_{CHG} = 2.5A, DCR = 6.5mΩ

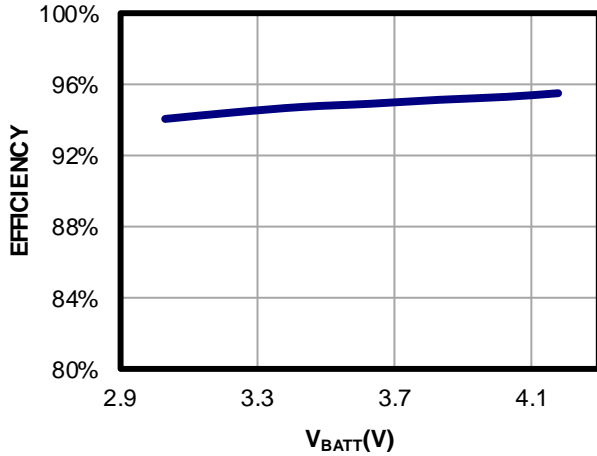

Constant Voltage Charge Efficiency

V_{IN} = 5V, V_{BATT} = 4.2V, DCR = 6.5mΩ

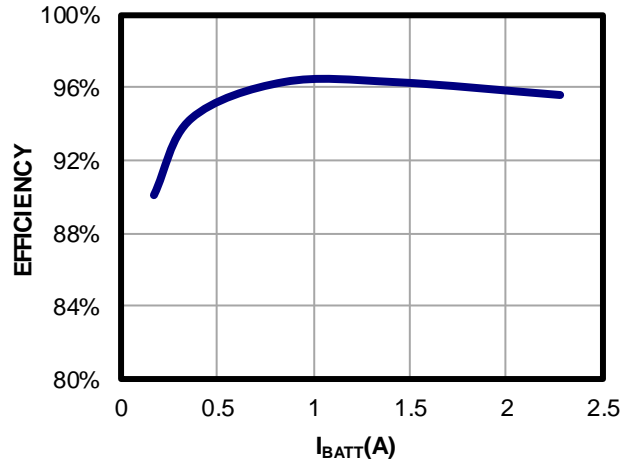

Boost Mode Efficiency

V_{BATT} = 3.5V, V_{SYS} = 5.15V, DCR = 6.5mΩ

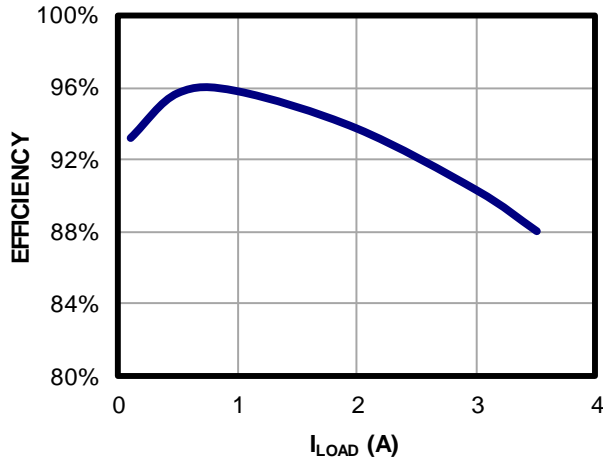

Battery Charge Curve

V_{IN} = 5V

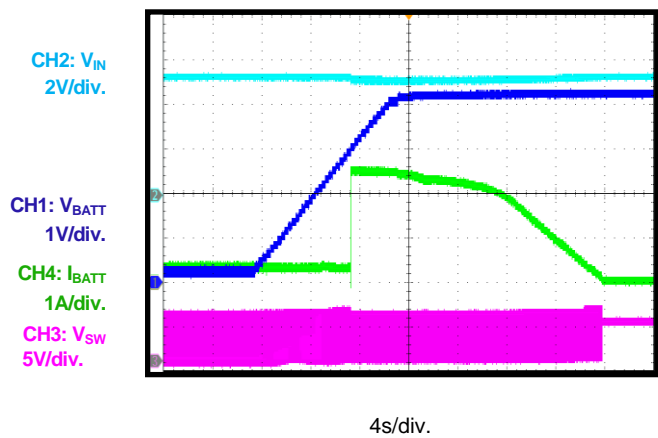

Pre-Charge Steady State

V_{IN} = 5V, V_{BATT} = 1.5V, I_{PRE} = 150mA

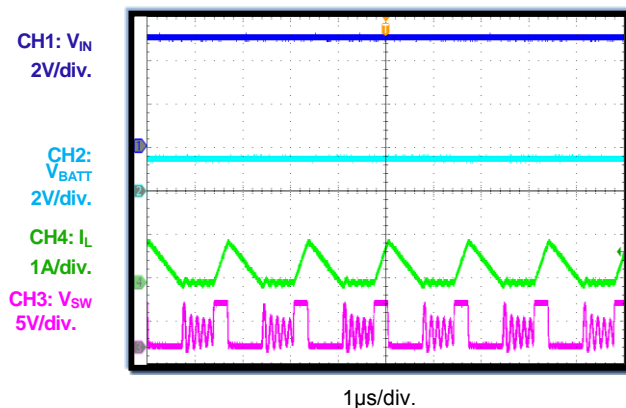

CC Charge Steady State

V_{IN} = 5V, V_{BATT} = 3.5V, I_{CC} = 2A

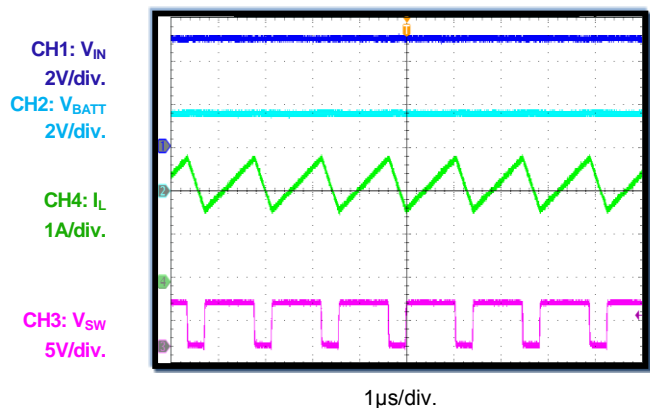

TYPICAL PERFORMANCE CHARACTERISTICS (continued)

 T_A = 25°C, battery simulator load, unless otherwise noted.

CV Charge Steady State

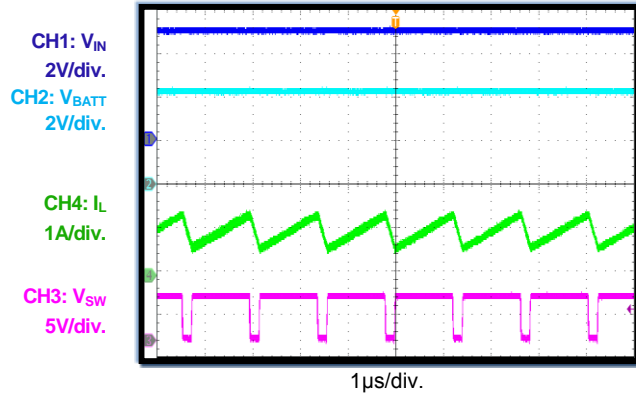
 V_{IN} = 5V, V_{BATT} = 4.2V

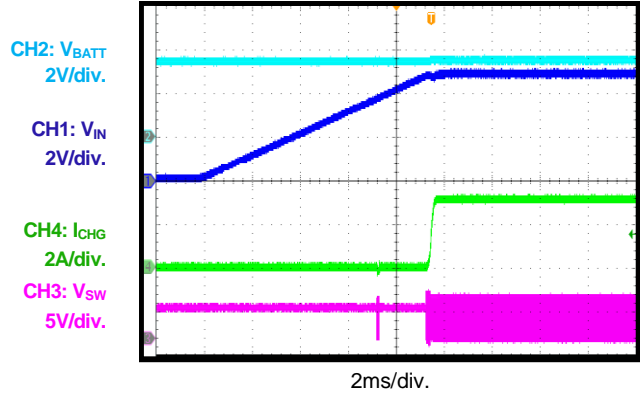
Power-On, CC Charge Mode

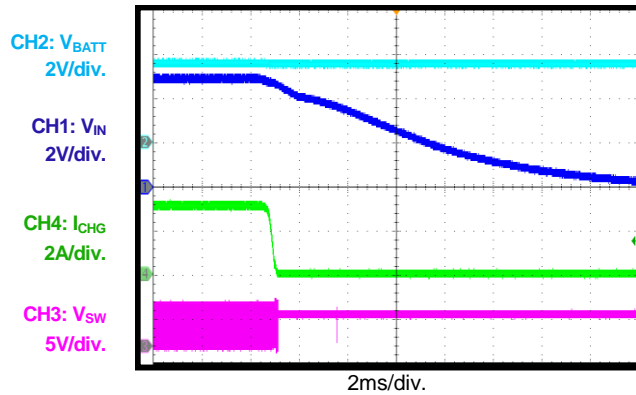
 V_{IN} = 5V, V_{BATT} = 3.5V, I_{CC} = 3A

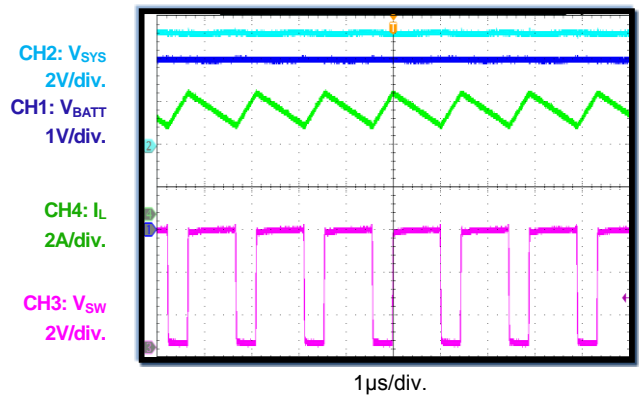
Power-Off, CC Charge Mode

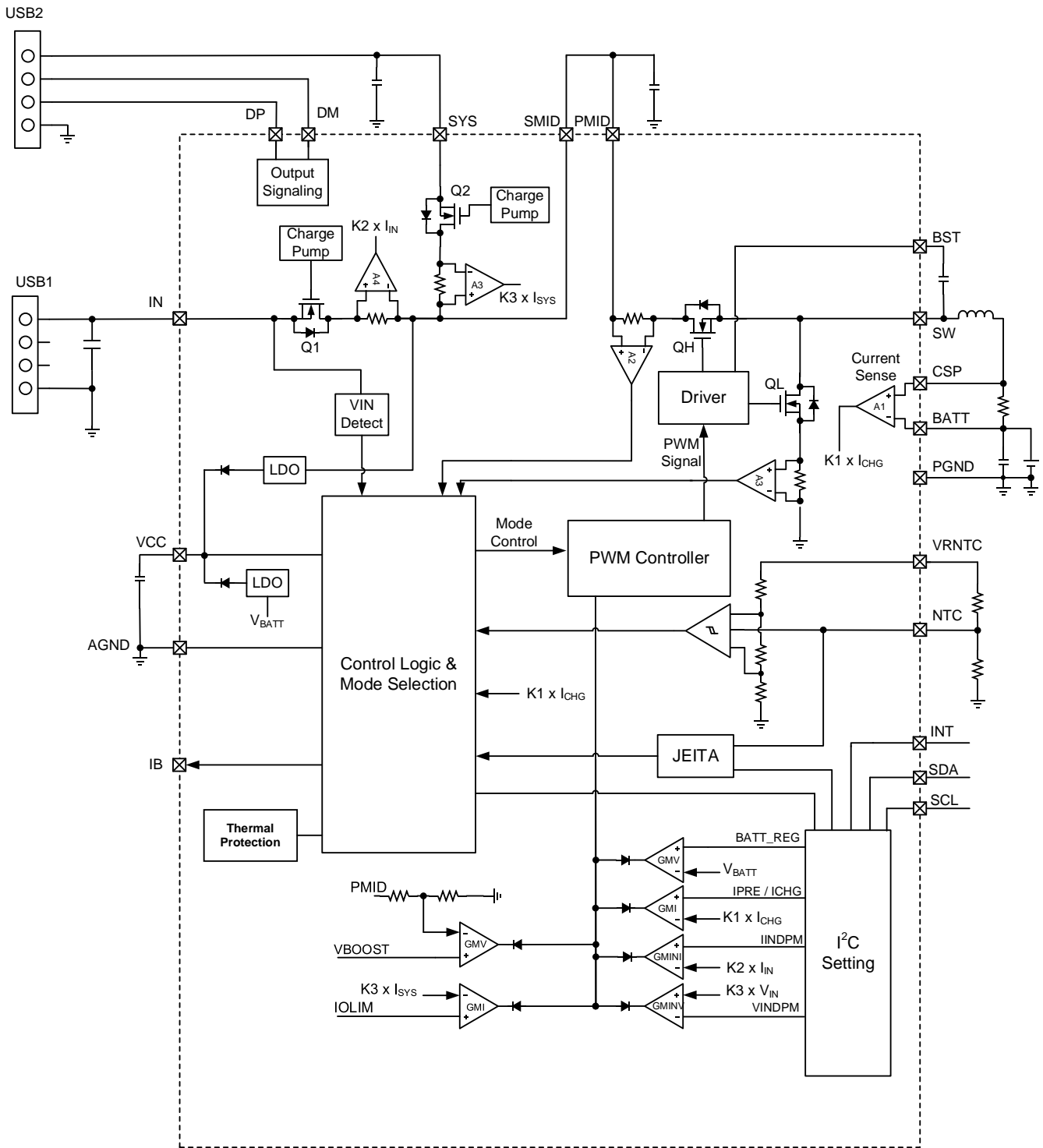
 V_{IN} = 5V, V_{BATT} = 3.5V, I_{CC} = 3A

Boost Steady State

 V_{BATT} = 4V, I_{sys} = 3.5A

FUNCTIONAL BLOCK DIAGRAM

Figure 2: Functional Block Diagram

OPERATION

Introduction

The MP2696A is an I²C-controlled switching charger with bidirectional operation that can step up the battery voltage (V_{BATT}) to power the system. Depending on the input and output status, it operates in one of the three modes: charge mode, boost mode, or idle mode. In charge mode, the IC supports a precision Li-ion or Li-polymer charging system for single-cell applications. In boost mode, the IC boosts V_{BATT} to a regulated voltage at SYS for powering the load. In idle mode, the IC stops charging or boosting and operates at a low current from the input or the battery to reduce the power consumption when the IC is not operating.

VCC Power Supply

VCC provides power for the internal bias circuit, as well as the low-side switch driver. VCC is powered from whichever voltage is the highest between PMID and BATT. When the VCC voltage rises above the V_{VCC_UV} threshold, the I²C interface is ready for communication, and all the registers are reset to the default value. When the device is switching, VCC can provide up to 30mA for the external load.

CHARGER MODE OPERATION

Battery Charging Profile

The IC can run a charging cycle autonomously without host involvement. Also, the host can control the charge operations and parameters via the registers.

A new charge cycle can start when the following conditions are valid:

- V_{IN} is above V_{IN_UV}
- V_{IN} is below V_{IN_OVP}
- V_{IN} is above $V_{BATT} + V_{HDRM}$
- The NTC voltage is in the proper range (if the NTC_STOP bit is set to 1)
- No charge timer fault
- Charging is enabled (CHG_EN=1)
- No battery over-voltage

After the charge is done, unplug and re-insert V_{IN} or toggle the CHG_EN bit to start a new charge cycle.

Charge Cycle

The IC checks the battery voltage to provide three main charging phases: pre-charge, constant-current (CC) charge, and constant-voltage (CV) charge.

The IC regulates the voltage drop on the current-sense resistor ($RS1$) for the battery pre-charge and constant-current charge current. Table 1 shows the default value for a 10m Ω resistor.

Table 1: Charge Current vs. Battery Voltage (RS1 = 10m Ω)

Battery Voltage	Charge Current	Default Value	CHG_STAT
BATT < 3V	IPRE[1:0]	150mA	01
BATT > 3V	ICC[4:0]	1A	10

The charge current can be scaled by implementing different current-sense resistor values. The fast-charge current (I_{CC}) can be calculated with Equation (1):

$$I_{CC} = \frac{ICC[4:0] * 10m\Omega}{RS1} \quad (1)$$

The pre-charge current (I_{PRE}) can be calculated with Equation (2):

$$I_{PRE} = \frac{IPRE[4:0] * 10m\Omega}{RS1} \quad (2)$$

Note that the soldering tin for the current-sense resistor has resistance, which needs to be compensated.

During the entire charging process, the actual charge current may be less than the register setting due to other loop regulations, such as the input current limit or the input voltage limit.

Charge Termination

Charging terminates if all the following conditions are met:

- The charge current is below the termination threshold for 20ms
- The IC works in a constant-voltage charge loop
- The IC is not in the input current loop or input voltage loop

After termination, the status register CHG_STAT is set to 11, and an INT pulse is generated.

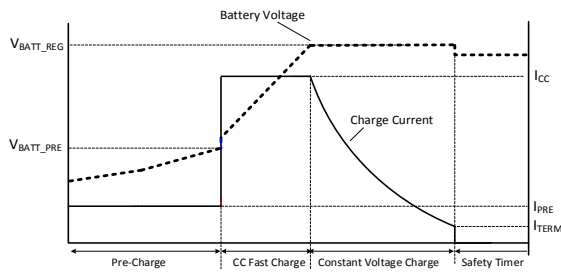
Figure 3: Battery Charge Profile

Automatic Recharge

When the battery is fully charged and the charging is terminated, the battery may be discharged because of the system consumption or self-discharge. When V_{BATT} is discharged below the recharge threshold ($V_{BATT_REG} - 200mV$), the IC starts a new charging cycle automatically if the input power is valid. The timer resets when the auto-recharge cycle begins.

Safety Timer

The IC provides a safety timer to prevent extended charging cycles due to abnormal battery conditions. The safety timer feature can be disabled via the I²C. The safety timer does not operate in boost mode.

The safety timer resets at the beginning of a new charging cycle. Two actions can restart the safety timer: a new charge cycle starting, or the EN_TIMER bit being toggled.

If the safety timer expires before the charge is done, then an INT pulse is generated, the charge cycle stops, and CHG_FAULT[1:0] becomes 11 (signaling a safety timer expiration). To clear this fault, unplug and reinsert VIN once the safety timer expires.

Input Voltage Based and Input Current Based Power Management

The IC features both input current and input voltage based power management by monitoring the input current and input voltage continuously.

When the input current reaches the limit set by IINLIM[2:0], the charge current tapers off to keep the input current from increasing further.

If the preset input current limit is higher than the adapter rating, the backup input voltage based power management also works to prevent the input source from being overloaded. When the input voltage falls below the input voltage regulation threshold set by VINMIN[2:0] due to the

heavy load, the charge current is also reduced to keep the input voltage from dropping further.

An INT pulse is generated once the device enters a VINPPM or INPPM condition.

Thermistor Qualification

VRNTC is driven to be the same as the VCC voltage when the IC is in charge/boost mode. The IC monitors the battery's temperature continuously by measuring the voltage at the NTC pins. The NTC function can be disabled by setting EN_NTC = 0.

When NTC_STOP is set to 1, the NTC voltage should be within the V_{HOT} to V_{COLD} range for both charge and boost operation. The IC resumes switching when the NTC voltage returns to the V_{HOT} to V_{COLD} range.

When NTC_STOP is set to 0, the IC only generates an interrupt (INT) signal and reports the NTC pin status if the NTC_FAULT[2:0] bits have any changes.

JEITA profile is supported when the JEITA_DIS bit is set to 0.

At a cool temperature (V_{COLD} to V_{COOL}) range, the charge current is reduced according to the JEITA_ISET[1:0] setting (see Figure 4).

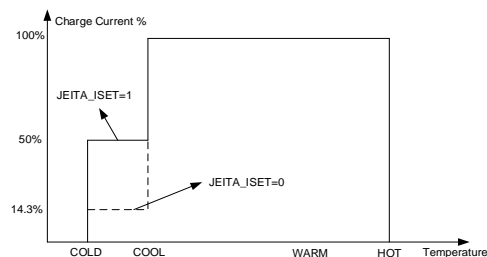
Figure 4: JEITA Profile – Charge Current

At a warm temperature (V_{WARM} to V_{HOT}) range, the charge voltage is reduced according to the JEITA_VSET[1:0] setting (see Figure 5).

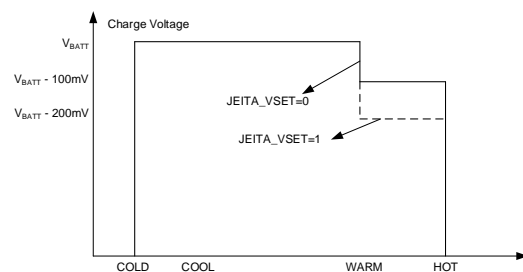
Figure 5: JEITA Profile – Charge Voltage

The HOT and COLD thresholds have two options in the register. The WARM and COOL thresholds have four options in the register, which offers accurate and flexible JEITA control.

Interrupt to Host (INT)

A 50µs interrupt pulse is generated on the open-drain INT pin when any of the events below occur:

- A good input source is detected
- A USB2 plug-in is detected
- Status register 05h changes
- Fault register 06h changes

Battery Over-Voltage Protection (OVP)

If V_{BATT} exceeds 104% of V_{BATT_REG} , then the IC stops charging, BATT_OVP is set to 1, and an INT pulse is generated. An 800µA current source discharges the battery until it returns to the normal range.

Battery over-voltage protection (OVP) can be disabled by setting BATT_OVP_DIS to 1.

Input Over-Voltage Protection (OVP)

If IN senses a voltage above the VIN_OVP threshold, then the DC/DC converter shuts down.

The input OVP threshold can be 6V, 11V, or set via VIN_OVP.

BOOST MODE OPERATION

The IC can supply a regulated 5V output at SYS to power the system. If V_{BATT} is below 2.9V, then the IC does not operate in boost mode to avoid draining the battery. In order to enable boost mode, V_{IN} must be below 2V.

The boost output current limit can be set between 2.1A and 3.6A. If $V_{SYS} > V_{BATT}$, then boost mode has an output current limit loop.

In boost mode, the IC first boosts PMID to the preset voltage, and then the block FET (Q2) turns on linearly. Once V_{SYS} exceeds 4.2V within 3ms, Q2 is turned on completely. Otherwise, Q2 turns off and tries to restarts again after 300ms.

Boost Power Limitation

During boost operation, the peak inductor current in each switching cycle is limited by the peak current limit of the low-side switch (Q4) BST_IPK[1:0] bits. This limits the maximum battery discharge current.

Battery Under-Voltage Lockout (UVLO) Protection

Once V_{BATT} drops below 2.5V during boost operation, boost mode stops and BATT_UVLO is set to 1. Boost mode recovers once V_{BATT} exceeds 2.9V. BATT_UVLO does not reset until the input source plug-in and battery is charged again.

SYS Over-Current and Short Protection

In boost mode, the MP2696A monitors the current flowing through Q2. If the SYS output current exceeds the preset boost output current limit, then the output current loop takes control and both the PMID voltage (V_{PMID}) and SYS voltage (V_{SYS}) decrease. If V_{SYS} drops to $V_{BATT} + 200mV$, then Q2 turns off. Q2 tries to restart again after 300ms.

The IC also features fast SYS over-current protection (OCP) in both boost mode and pass-through mode. If the Q2 current exceeds 8A, then Q2 turns off. Q2 tries to restart again after 300ms.

Impedance Compensation for Boost Output

The Q2 intrinsic resistance and the USB2 output wire voltage drop can be compensated by adjusting the boost output voltage according to the system load current. The PMID voltage (V_{PMID}) can be calculated with Equation (3):

$$V_{PMID} = V_{BOOST} + (I_{SYS} \times R_{SYS_CMP}) \quad (3)$$

Where V_{BOOST} is the boost regulation voltage set by VBOOST[2:0], I_{SYS} is the real-time SYS load current during operation, and R_{SYS_CMP} is the line resistance compensation set by RSYS_CMP[2:0].

USB2 Plug-In Detection

If USB2_EN_PLUG is on in standby mode, then SYS is pulled up to BATT. Detection starts once V_{SYS} reaches 90% of V_{BATT} . If the system voltage drops to 75% of V_{BATT} , then the USB2 plug-in is detected, USB2_PLUG_IN is set to 1, and an INT pulse signal is generated.

The host responds to the INT signal and enables boost mode/Q2.

For the next detection, the host must clear USB2_PLUG_IN and toggle USB2_EN_PLUG. Writing 1 to USB2_PLUG_IN clears it to 0.

No Load Detection

Q2 current is monitored in boost mode and pass-through mode. If the Q2 current is below NOLOAD_THR[1:0], then NO_LOAD is set to 1

and an INT pulse is generated. The host can monitor NO_LOAD and decide whether boost mode/Q2 should be turned off.

Thermal Shutdown

The IC monitors the internal junction temperature to maximize power delivery and avoid overheating the chip. If the IC's junction temperature exceeds the threshold value (typically 150°C), then the converter shuts down. If the junction temperature drops to about 120°C, the MP2696A resumes normal operation.

Battery Current Analog Output

The IC has an IB pin to monitor the real-time battery current in both charge mode and boost mode. The IB voltage (V_{IB}) is a fraction of the battery current. It indicates the current flowing in and out of the battery during charge mode and boost mode.

If using a 10mΩ current-sense resistor in charge mode, the IB voltage (V_{IB}) can be calculated with Equation (4):

$$V_{IB} = I_{CHG} \times 0.36(V) \quad (4)$$

If using a 10mΩ current-sense resistor in boost mode, the IB voltage (V_{IB}) can be calculated with Equation (5):

$$V_{IB} = I_{DCHG} \times 0.16(V) \quad (5)$$

Note that scaling the current-sense resistor also scales the IB gain.

Idle Mode

If the input power source is not present and boost mode is disabled, then the IC goes into idle mode. In idle mode, all the FETs and most of the internal circuits are turned off to minimize leakage and extend the battery runtime.

SYS DP/DM Signaling

For a nonstandard adapter imitation, the DP and DM pins are initially biased at 2.7V, with a 30kΩ internal resistance.

The IC operates in DCP mode when the DP or DM pin is outside of the 2.1V to 2.9V range for 10ms. The 2.7V reference is disconnected, and DP and DM are tied together via a 100Ω resistor.

If DP is less than 0.35V for 2s in DCP mode, then the IC returns to nonstandard adapter mode with a DP/DM biased at 2.7V.

Series Interface

The IC uses an I²C interface for setting the charging parameters and device status reporting. The I²C is a two-wire serial interface with two bus lines: a serial data line (SDA) and serial clock line (SCL). Both SDA and SCL are open drains that must be connected to the positive supply voltage via a pull-up resistor.

The IC operates as a slave device, receiving control inputs from the master device (e.g. a micro-controller). SCL is driven by the master device. The I²C interface supports both standard mode (up to 100 kbit/s) and fast mode (up to 400 kbit/s).

All transactions begin with a start (S) command and are terminated by a stop (P) command. The start and stop commands are generated by the master. A start command is defined as a high to low transition on SDA while SCL is high. A stop command is defined as a low to high transition on SDA while SCL is high. Figure 6 shows the start and stop commands.

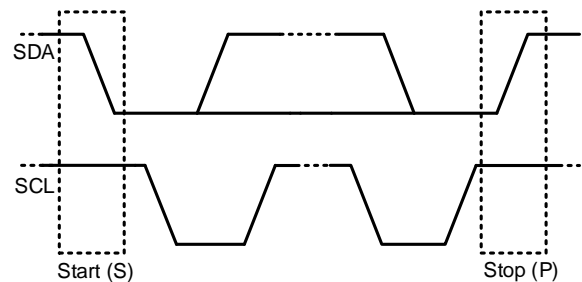

Figure 6: Start and Stop Conditions

For data validity, the data on SDA must be stable during the high clock period. The SDA high and low states only change if the clock signal on SCL is low. Every byte on SDA must be 8 bits long. The number of bytes transmitted per transfer is unrestricted. Data is transferred with the most significant bit (MSB) first.

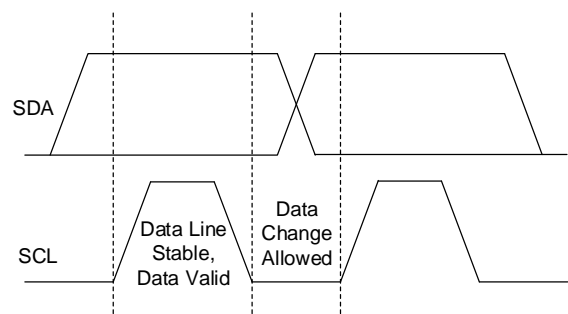

Figure 7: Bit Transfer on the I²C Bus

To signal that a byte was successfully received by the transmitter, each byte has to be followed by an acknowledge (ACK) bit generated by the receiver.

The ACK signal is defined as follows: The transmitter releases SDA during the ACK clock pulse and the receiver pulls SDA low. SDA remains low during the 9th clock's high period.

If SDA is high during the 9th clock, then the signal is defined as a not acknowledged (NACK) signal. The master then generates either a stop to abort the transfer or a repeated start to begin a new transfer.

After the start signal, a slave address is sent. This address is 7 bits long, followed by an 8th data direction bit (bit R/W). A 0 indicates a transmission (write), and a 1 indicates a request for data (read). Figure 8 shows the address arrangement.

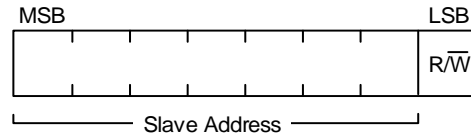

Figure 8: 7-Bit Addressing

See Figure 9, Figure 10, Figure 11, Figure 12, and Figure 13 for detailed signal sequences.

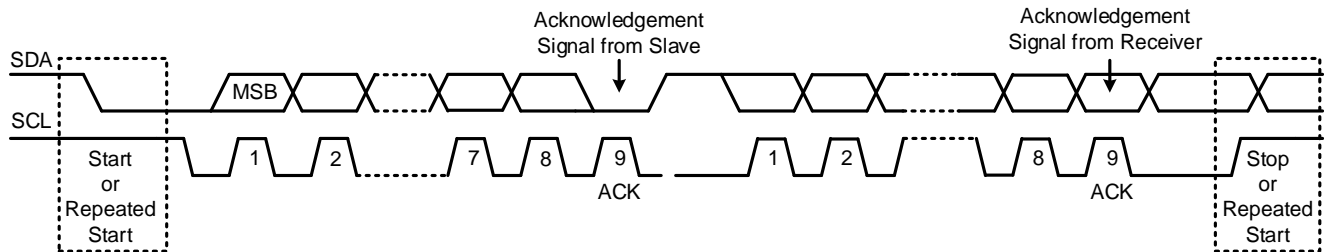

Figure 9: Data Transfer on the I²C Bus

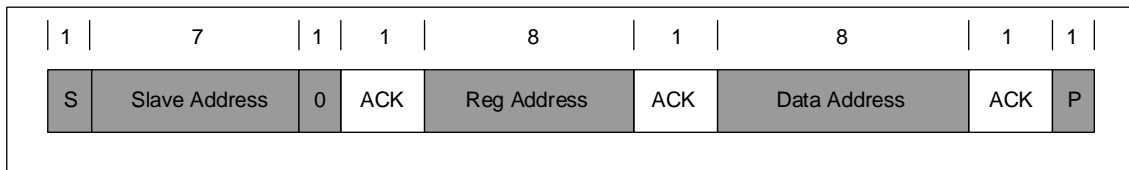

Figure 10: Single-Write

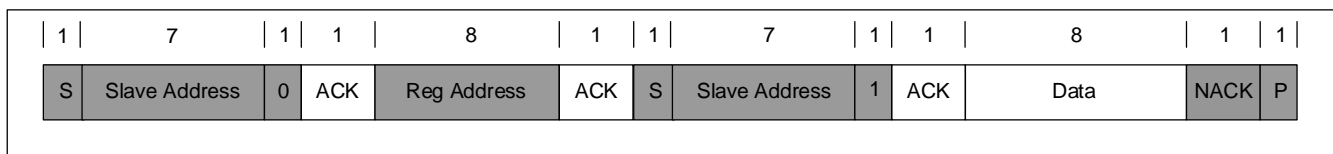
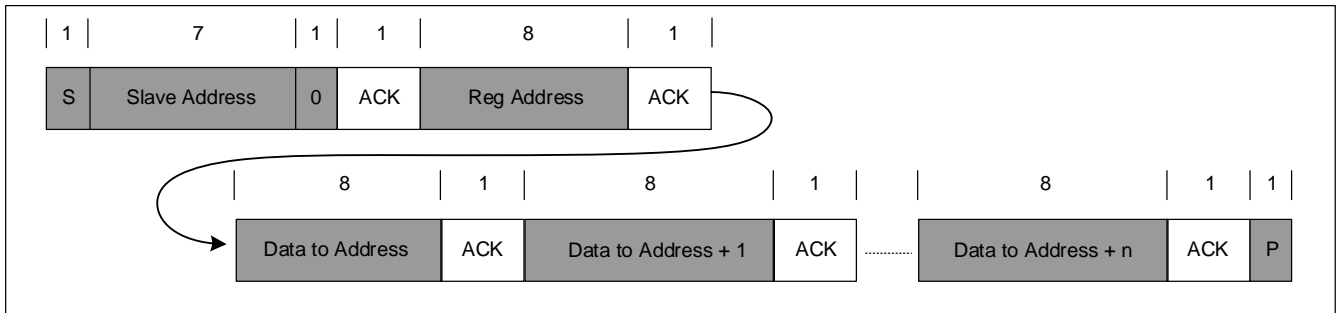
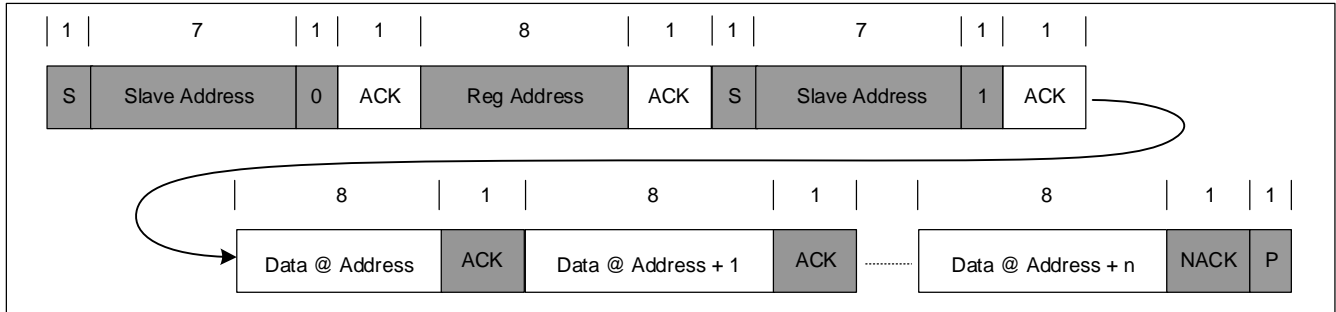

Figure 11: Single-Read

Figure 12: Multi-Write

Figure 13: Multi-Read

I²C REGISTER MAP

IC Address: 6Bh

Register Name	Address	R/W	Description
REG00h	0x00	R/W	Input voltage regulation setting and input current limit setting.
REG01h	0x01	R/W	Charge current setting and pre-charge current setting.
REG02h	0x02	R/W	Battery regulation voltage and termination current setting.
REG03h	0x03	R/W	Boost output current limit setting and cable impedance compensation.
REG04h	0x04	R/W	Boost output voltage setting and boost control.
REG05h	0x05	R	Status register.
REG06h	0x06	R	Fault register.
REG07h	0x07	R/W	Boost no load setting and miscellaneous control.
REG08h	0x08	R/W	JEITA control.

REG 00h

Bit	Name	POR	Reset by REG_RST	R/W	Description	Comment
7	REG_RST	0	Y	R/W	0: Keeps current setting 1: Reset	Resets all registers to default. After reset, this bit returns to 0.
6	EN_TIMER	1	Y	R/W	0: Disabled 1: Enabled (default)	Enables the safety timer.
5	VINMIN[2]	1	Y	R/W	200mV (default)	Sets the input voltage dynamic regulation. Offset: 4.45V Range: 4.45V to 4.8V Default: 4.65V (200mV)
4	VINMIN[1]	0	Y	R/W	100mV	
3	VINMIN[0]	0	Y	R/W	50mV	
2	IINLIM[2]	0	Y	R/W	000: 100mA 001: 500mA (default) 010: 1000mA 011: 1500mA 100: 1800mA 101: 2100mA 110: 2400mA 111: 3000mA	Sets the input current limit.
1	IINLIM[1]	0	Y	R/W		
0	IINLIM[0]	1	Y	R/W		

REG 01h

Bit	Name	POR	Reset by REG_RST	R/W	Description	Comment
7	ICC[4]	0	Y	R/W	1600mA	Sets the charge current for the 10mΩ current-sense resistor. Offset: 500mA Range: 500mA to 3.6A Default: 1A A scaling current-sense resistor scales the setting at the same ratio.
6	ICC[3]	0	Y	R/W	800mA	
5	ICC[2]	1	Y	R/W	400mA	
4	ICC[1]	0	Y	R/W	200mA	
3	ICC[0]	1	Y	R/W	100mA	
2	EN_NTC	1	Y	R/W	0: Disabled 1: Enabled (default)	
1	IPRE[1]	0	Y	R/W	01: 150mA (default) 10: 250mA 11: 350mA	Sets the pre-charge current for the 10mΩ current-sense resistor. Range: 150mA to 350mA
0	IPRE[0]	1	Y	R/W		

REG 02h

Bit	Name	POR	Reset by REG_RST	R/W	Description	Comment
7	BATT_OVP_DIS	0	Y	R/W	0: Enabled (default) 1: Disabled	Enables OVP battery function.
6	BATT_REG[2]	0	Y	R/W	000: 3.6V 001: 4.1V 010: 4.2V (default) 011: 4.3V 100: 4.35V 101: 4.4V 110: 4.45V	Sets the charge voltage regulation.
5	BATT_REG[1]	1	Y	R/W		
4	BATT_REG[0]	0	Y	R/W		
3	JEITA_DIS	1	Y	R/W		
2	ITERM[1]	0	Y	R/W	200mA	Sets the charge termination current for the 10mΩ current-sense resistor. Offset: 100mA Range: 100mA to 400mA
1	ITERM[0]	0	Y	R/W	100mA	
0	CHG_EN	1	Y	R/W	0: Disabled 1: Enabled (default)	Enables charge mode.

REG 03h

Bit	Name	POR	Reset by REG_RST	R/W	Description	Comment
7	IOLIM[1]	1	Y	R/W	800mA	Sets the SYS output current limit. Offset: 2.1A Range: 2.1A to 3.6A Default: 3A
6	IOLIM[0]	0	Y	R/W	400mA	
5	IOLIM[1]	0	Y	R/W	200mA	
4	IOLIM[0]	1	Y	R/W	100mA	
3	RSYS_CMP[2]	0	Y	R/W	80mΩ	Sets the SYS cable voltage drop compensation. Default: 60mΩ
2	RSYS_CMP[1]	1	Y	R/W	40mΩ	
1	RSYS_CMP[0]	1	Y	R/W	20mΩ	
0	NO_LOAD	0	Y	R	0: Q2 normal load 1: Q2 no load	

REG 04h

Bit	Name	POR	Reset by REG_RST	R/W	Description	Comment
7	VBOOST[2]	0	Y	R/W	-100mV	Sets the PDIM pin's boost regulation voltage. Offset: 5.2V Range: 5.05V to 5.225V Default: 5.15V
6	VBOOST[1]	1	Y	R/W	-50mV	
5	VBOOST[0]	0	Y	R/W	25mV	
4	BST_EN	0	Y	R/W	0: Disabled (default) 1: Enabled	Enables boost mode. Boost mode can only be enabled once $V_{IN} < 2V$.
3	Q2_EN	0	Y	R/W	0: Off (default) 1: On	Turns Q2 on.
2	SYS_DSC	0	Y	R/W	0: Disabled 1: Enabled	Enables the SYS to GND discharge resistance (25Ω).
1	USB2_EN_PLUG	1	Y	R/W	0: Disabled 1: Enabled	Enables the USB2 plug-in detection circuit. Toggle this bit for new detection.
0	USB2_PLUG_IN	0	Y	R/W	0: USB2 is not plugged in 1: USB2 plug-in detected	If SYS exceeds 90% of V_{BATT} , then plug-in detection begins. If SYS drops to 75% of V_{BATT} , then the USB2 plug-in signal is asserted. Write 1 to reset this bit to 0. This bit should be cleared manually after read to enable the next detection.

REG 05h

Bit	Name	POR	Reset by REG_RST	R/W	Description	Comment
7	CHIP_STAT[1]	0	Y	R	00: Idle 01: Charge mode 10: Boost mode 11: Power path and charge mode	
6	CHIP_STAT[0]	0	Y	R		
5	CHG_STAT[1]	0	Y	R	00: Not charging 01: Pre-charge mode 10: CC or CV charge mode 11: Charge complete	
4	CHG_STAT[0]	0	Y	R		
3	VPPM_STAT	0	Y	R	0: Does not enter V _{IN_LIM} loop 1: Enters V _{IN_LIM} loop	
2	IPPM_STAT	0	Y	R	0: Does not enter I _{IN_LIM} loop 1: Enters I _{IN_LIM} loop	
1	USB1_PLUG_IN	0	Y	R	0: USB1 is not plugged in 1: USB1 is plugged in	If (V _{IN_UV} , V _{BATT} + V _{HDRM}) < V _{IN} < V _{IN_OVP} , then this bit is set to 1.
0	RESERVED	0	Y	R		

An interrupt signal is asserted when any bit in this register changes.

REG 06h

Bit	Name	POR	Reset by REG_RST	R/W	Description	Comment
7	BATT_UVLO	0	Y	R	0: No Battery ULVO 1: Battery UVLO	If V _{BATT} is below the UVLO threshold, then this bit is set to 1. Once the battery is charged again, this bit resets to 0.
6	SYS_SHORT	0	Y	R	0: Normal 1: SYS short circuit	
5	BST_LMT	0	Y	R	0: Normal 1: Boost mode works in Q2 current limit	
4	CHG_FAULT[1]	0	Y	R	00: Normal 01: USB1 UV 10: USB1 OV 11: Safety timer expiration	
3	CHG_FAULT[0]	0	Y	R		
2	NTC_FAULT[2]	0	Y	R	000: Normal 001: Warm 010: Cool 011: Cold 100: Hot	
1	NTC_FAULT[1]	0	Y	R		
0	NTC_FAULT[0]	0	Y	R		

An interrupt signal is asserted when any bit in this register changes.

REG 07h

Bit	Name	POR	Reset by REG_RST	R/W	Description	Comment
7	NOLOAD_THR[1]	0	Y	R/W	00: 30mA (default) 01: 50mA 10: 75mA 11:100mA	Sets the SYS no load current threshold.
6	NOLOAD_THR[0]	0	Y	R/W		
5	BATT_OVP	0	Y	R	0: Battery normal 1: Battery OVP	
4	NTC_STOP	1	Y	R/W	0: NTC out of window, only reports in register 1: NTC out of window, suspends the charge and boost operation	
3	VIN_OVP	0	Y	R/W	0: 6V 1: 11V	
2	SW_FREQ	0	Y	R/W	0: 700kHz (default) 1: 1200kHz	
1	BST_IPK[1]	1	Y	R/W	00: 5A 01: 5.5A 10: 6A 11: 6.5A (default)	Low-side switch peak current limit in boost mode.
0	BST_IPK[0]	1	Y	R/W		

REG 08h

Bit	Name	POR	Reset by REG_RST	R/W	Description	Comment
7	JEITA_VSET	1	Y	R/W	0: V _{BATT_REG} - 100mV 1: V _{BATT_REG} - 200mV	Default: V _{BATT_FULL} - 200mV
6	JEITA_ISET	1	Y	R/W	0: 14.3% of I _{CC} 1: 50% of I _{CC} (default)	
5	VHOT	1	Y	R/W	0: 34% 1: 36% (default)	Sets the hot threshold.
4	VWARM[1]	0	Y	R/W	00: 44% 01: 40% (default) 10: 38% 11: 36%	Sets the warm threshold.
3	VWARM[0]	1	Y	R/W		
2	VCOOL[1]	1	Y	R/W	00: 72% 01: 68% 10: 64% 11: 60% (default)	Sets the cool threshold.
1	VCOOL[0]	1	Y	R/W		
0	VCOLD	0	Y	R/W	0: 72% (default) 1: 68%	Sets the cold threshold.

REG 0Ah ⁽⁸⁾

Bit	Name	POR	Reset by REG_RST	R/W	Description	Comment
7	TMR	0	N/A	N/A	0: 20hr charge timer (default) 1: 10hr charge timer	
6	RESERVED	N/A	N/A	N/A	N/A	
5	RESERVED	N/A	N/A	N/A	N/A	
4	RESERVED	N/A	N/A	N/A	N/A	
3	VPRE	0	N/A	N/A	0: 3V pre-charge threshold (default) 1: 2.5V pre-charge threshold	
2	RESERVED	N/A	N/A	N/A	N/A	
1	RESERVED	N/A	N/A	N/A	N/A	
0	RESERVED	N/A	N/A	N/A	N/A	

Note:

8) Register 0Ah is for OTP only and is not accessible to users.

OTP MAP

#	Bit7	Bit6	Bit5	Bit4	Bit3	Bit2	Bit1	Bit0
0x02	N/A	BATT_REG: 3.6V to 4.45V			N/A	N/A	N/A	N/A
0x07	NOLOAD_THR		N/A	NTC_STOP	VIN_OVP	N/A	N/A	N/A
0x0A	TMR	N/A	N/A	N/A	VPRE	N/A	N/A	N/A

OTP DEFAULT

OTP Items	Default
BATT_REG[2:0]	4.2V
NOLOAD_THR[1:0]	30mA
NTC_STOP	1: NTC out of window, suspends charge and boost operation
VIN_OVP	0: VIN_OVP is 6V
TMR	0: 20hr charge timer
VPRE	0: 3V pre-charge threshold

APPLICATION INFORMATION

NTC Function

JEITA profile is supported for battery temperature management. For a given NTC thermistor, select an appropriate R_{T1} and R_{T2} to set the NTC window. R_{T1} can be calculated with Equation (6):

$$R_{T1} = \frac{R_{NTC_HOT} \times R_{NTC_COLD} \times (V_{COLD} - V_{HOT})}{V_{COLD} \times V_{HOT} \times (R_{NTC_COLD} - R_{NTC_HOT})} \quad (6)$$

R_{T2} can be calculated with Equation (7):

$$R_{T2} = \frac{R_{NTC_HOT} \times R_{NTC_COLD} \times (V_{COLD} - V_{HOT})}{V_{HOT} \times (1 - V_{COLD}) \times R_{NTC_COLD} - V_{COLD} \times (1 - V_{HOT}) \times R_{NTC_HOT}} \quad (7)$$

Where R_{NTC_HOT} is the value of the NTC resistor at the upper bound of its operating temperature range, and R_{NTC_COLD} is its lower bound. V_{HOT} is the hot temperature threshold percentage, which can be selected as 34% or 36%. V_{COLD} is the cold temperature threshold percentage, which can be selected as 72% or 68%.

The warm temperature threshold (V_{WARM}) can be calculated with Equation (8):

$$V_{WARM} = \frac{R_{T2} // R_{NTC_WARM}}{R_{T1} + R_{T2} // R_{NTC_WARM}} \quad (8)$$

The cool temperature threshold (V_{COOL}) can be calculated with Equation (9):

$$V_{COOL} = \frac{R_{T2} // R_{NTC_COOL}}{R_{T1} + R_{T2} // R_{NTC_COOL}} \quad (9)$$

Choose the nearest warm/cool threshold in REG08h using the results from the calculations above.

If no external NTC is available, connect R_{T1} and R_{T2} to keep the voltage on NTC within the valid NTC window (e.g. $R_{T1} = R_{T2} = 10k\Omega$).

Selecting the Inductor

Inductor selection requires a tradeoff between cost, size, and efficiency. A lower inductance value means a smaller size, but results in greater current ripple, greater magnetic hysteretic losses, and greater output capacitance. A higher inductance value benefits from lower ripple current and smaller output filter capacitors, but results in greater inductor DC resistance (DCR) loss. Table 2 shows recommended values with

which to choose an inductor.

Table 2: Inductance Selection Guide

RS1 (mΩ)	Max I _{CC} (A)	L (μH)
10	3.6	1
20	1.8	2.2
30	1.2	3.3
50	0.72	4.7

Choose an inductor that does not saturate under the worst-case load condition.

Selecting the PMID Capacitor (C_{PMID})

Select C_{PMID} based on the demand of the PMID current ripple for the mode being used.

In charge mode, C_{PMID} acts as the input capacitor of the buck converter in charge mode. The input current ripple (I_{RMS_MAX}) can be calculated with Equation (10):

$$I_{RMS_MAX} = I_{CC_MAX} \times \frac{\sqrt{V_{BATT} \times (V_{IN} - V_{BATT})}}{V_{IN}} \quad (10)$$

In boost mode, C_{PMID} is the output capacitor of the boost converter. C_{PMID} keeps the system voltage ripple small and ensures feedback loop stability. The system current ripple (I_{RMS_MAX}) can be calculated with Equation (11):

$$I_{RMS_MAX} = I_{BATT} \times \frac{\sqrt{V_{BATT} \times (V_{SYS} - V_{BATT})}}{V_{SYS}} \quad (11)$$

Select the PMID capacitors based on the ripple current temperature rise, not exceeding 10°C. For best results, use ceramic capacitors with X5R dielectrics because of their low ESR and small temperature coefficients.

Compensate the Current-Sense Resistor

The soldering tin has resistance. For a 10mΩ resistor soldered on the PCB, the total resistance between resistor pads is about 11mΩ to 12mΩ. One compensation method is to apply a resistor divider for the CSP/BATT pins (see Figure 14 on page 30). After the PCB is assembled, apply a 2A DC current source between SW and BATT, measure the voltage drop across the current-sense resistor on its PCB pads (V_{CS}). Then $R1$ can be calculated using Equation (12):

$$R1 = \frac{V_{CS} - 2 \times RS1}{2 \times RS1} \times 10\Omega \quad (12)$$

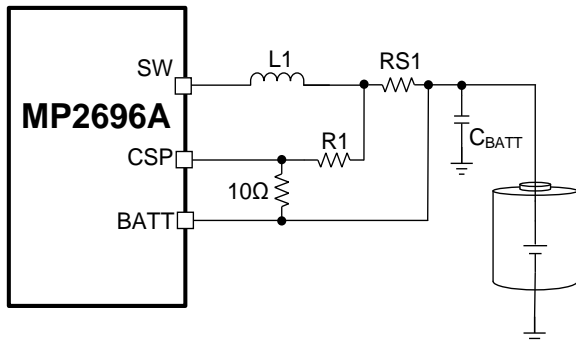
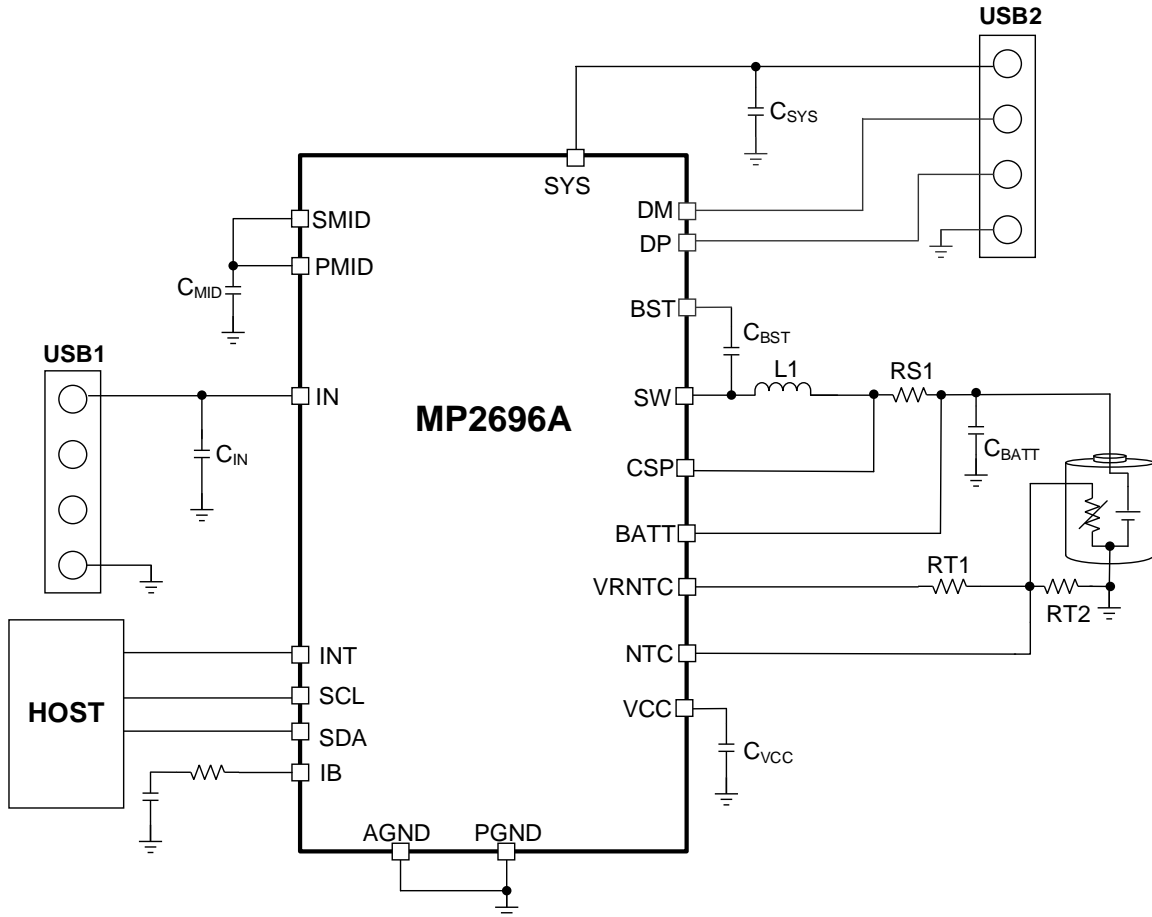

Figure 14: Current-Sense Compensation

PCB Layout Guidelines

Efficient PCB layout is critical to meet specified noise, efficiency, and stability requirements. For the best results, follow the guidelines below:

1. Place the PMID capacitor as close as possible to PMID and PGND. The PMID capacitor should have a return to the IC's PMID and PGND pins that is as short as possible.
2. Connect AGND to the ground of the PMID capacitor.
3. Keep the switching node short.
4. The power pads for VIN, PMID, SYS, and PGND should be connected to as many coppers planes on the board as possible to improve thermal performance by conducting heat to the PCB.

TYPICAL APPLICATION CIRCUIT

Figure 15: Typical Application Circuit for Power Bank
Table 3: Key BOM for Figure 15

Qty	Ref	Value	Description	Package	Manufacture
1	C _{IN}	1μF	Ceramic capacitor, 16V, X5R or X7R	0603	Any
1	C _{MID}	10μF	Ceramic capacitor, 16V, X5R or X7R	0805	Any
2	C _{SYS}	10μF	Ceramic capacitor, 16V, X5R or X7R	0805	Any
1	C _{BATT}	22μF	Ceramic capacitor, 10V, X5R or X7R	0805	Any
1	C _{VCC}	2.2μF	Ceramic capacitor, 6.3V, X5R or X7R	0603	Any
1	C _{BST}	470nF	Ceramic capacitor, 16V, X5R or X7R	0603	Any
1	L1	1μH	Inductor, 1μH, low DCR	SMD	Any
1	RS1	10mΩ	Film resistor, 1%	1206	Any

PACKAGE INFORMATION

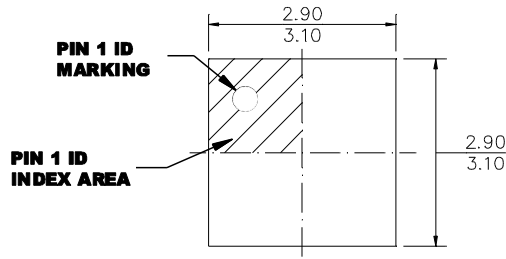
QFN-21 (3mmx3mm)



TOP VIEW

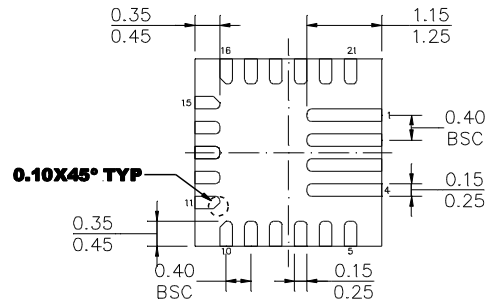

BOTTOM VIEW

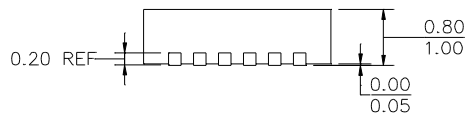

SIDE VIEW

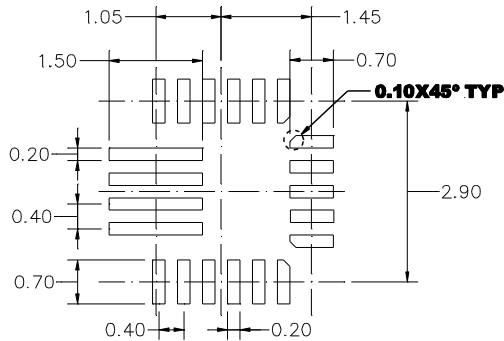

RECOMMENDED LAND PATTERN

NOTE:

- 1) ALL DIMENSIONS ARE IN MILLIMETERS.
- 2) LEAD COPLANARITY SHALL BE 0.08 MILLIMETERS MAX.
- 3) JEDEC REFERENCE IS MO-220.
- 4) DRAWING IS NOT TO SCALE.

REVISION HISTORY

Revision #	Revision Date	Description	Pages Updated
1.0	07/02/2019	Initial Release	-
1.01	01/15/2020	Updated the evaluation board part number from “EV2696A-Q-00A” to “EV2696A-Q-00B” in the Evaluation Kit EVKT-MP2696A section	3
1.02	07/20/2020	Updated the IB pin I/O description	5
		Added comment in the PMID pin description about not carrying current	
1.1	04/28/2021	Updated the I/O property of the IB, SCL, VRNTC, and BST pins in the Pin Functions table	5
		Changed the supply voltage range in the Recommended Operating Conditions section from “4.5V to +11V” to “4V to 11V” for consistency	6
		Changed IN OVP symbol in the Electrical Characteristics table from “V _{IN_OV} ” to “V _{IN_OVP} ” for consistency	9
		Updated graphs titles	11–12
		Changed “V _{IN_OV} ” to “V _{IN_OVP} ” for consistency; added abbreviation for battery voltage (V _{BATT}); updated the ICC default value in Table 1; updated descriptions for Equation 1 and Equation 2	16
		Updated the Safety Timer section; added abbreviation for interrupt (INT)	17
		Updated description for Equation 3	18
		Updated descriptions for Equation 4 and Equation 5	19
		Updated I ² C sections	18–21
		Updated I ² C Register Map section	22–28
		Updated descriptions for Equations 6 through 12	29
		Updated Package Information	32
		Formatting updates and clerical updates; like updated Figure numbers; changed “current-sensing” to “current-sense”; changed “adaptor” to “adapter”	All

Notice: The information in this document is subject to change without notice. Please contact MPS for current specifications. Users should warrant and guarantee that third-party Intellectual Property rights are not infringed upon when integrating MPS products into any application. MPS will not assume any legal responsibility for any said applications.

X-ON Electronics

Largest Supplier of Electrical and Electronic Components

Click to view similar products for [Battery Management](#) category:

Click to view products by [Monolithic Power Systems](#) manufacturer:

Other Similar products are found below :

[MP26121DQ-LF-P](#) [NCP1855FCCT1G](#) [FAN54063UCX](#) [LC05132C01NMTTTG](#) [SN2040DSQR](#) [ME4075AM5G](#) [AP5054HTCER](#) [XPD977B](#)
[XPD977B18](#) [4056H](#) [DW01](#) [DW06](#) [CM1002-UD](#) [CM1002-W](#) [CM1002-X](#) [CM1002-Y](#) [CM1006-B](#) [CM1006-Q](#) [CM1006-WB](#) [CM1006-LCD](#)
[CM1006-LBD](#) [CM1006-WF](#) [CM1006-LF](#) [CM1006-WG](#) [CM1006-WH](#) [CM1006-LG](#) [CM1003-S02BD](#) [CM1003-S09EA](#) [CM1003-S10ED](#)
[CM1003-S11ED](#) [CM1003-S12BC](#) [CM1003-S13CC](#) [CM1003-S24BC](#) [CM1003-S26BC](#) [CM1003-WAD](#) [CM1003-BBD](#) [CM1003-BFD](#)
[CM1003-BND](#) [CM1003-BLD](#) [CM1003-DAD](#) [CM1003-BMD](#) [CM1003-BPD](#) [CM1003-BKD](#) [CM1003-BAE](#) [CM1003-BHE](#) [CM1102B-FF](#)
[CM1102B-FD](#) [CM1102B-GD](#) [CM1112-DAE](#) [CM1112-DBE](#)